

Department of Defense

**Assured Services (AS)
Session Initiation Protocol (SIP) 2013
(AS-SIP 2013) Errata-1**



July 2013

The Office of the DoD Chief Information Officer

DEPARTMENT OF DEFENSE

ASSURED SERVICES SESSION INITIATION PROTOCOL 2013 (AS-SIP 2013) Errata-1

AS-SIP 2013, Errata Table

ERRATA #	REQ-ID	CORRECTION	EFFECTIVE DATE
1	SIP-000005	Added an optional requirement for SC interoperability AS-SIP line side interface and the capability to service AS-SIP EIs.	Immediate
1	SIP-000056	Added an optional requirement for the SC to keep track of the EI category.	Immediate
1	SIP-000057	Added requirement for when an SC receives and initial INVITE or a REFER from a served AS-SIP EI and the Initial INVITE or REFER doesn't include a Resource-Priority header field.	Immediate
1	SIP-000058	Added requirement for when an SC receives a re-INVITE or UPDATE from a served AS-SIP EI that does not include a Resource-Priority header field.	Immediate
1	SIP-004340	Specified [Required: AS-SIP EIs with P&P].	Immediate
1	SIP-004340.a	Specified [Required: AS-SIP EIs with P&P].	Immediate
1	SIP-004350	Added qualifier "or on behalf of a served RO AS-SIP EI".	Immediate
1	SIP-004350.a	Added qualifier "or on behalf of a served RO AS-SIP EI".	Immediate
1	SIP-004360	Specified [Required: AS-SIP EIs with P&P].	Immediate
1	SIP-004360.a	Specified [Required: AS-SIP EIs with P&P].	Immediate
1	SIP-004390	Changed "UC-SIP EI" to "AS-SIP EI with P&P".	Immediate
1	SIP-004440	Changed "AS-SIP EI" to AS-SIP EI with P&P.	Immediate
1	SIP-004474	Added a requirement for when an SC receives an INVITE, UPDATE or REFER request from a served AS-SIP EI that does not contain a Resource-Priority header field.	Immediate
1	SIP-004476	Added a requirement for when an SC receives an initial INVITE from a served AS-SIP EI in which the value of the precedence digit signifies a call priority greater than 'routine'.	Immediate
1	SIP-004478	Added a requirement for when an SC receives an initial INVITE from a served RO AS-SIP EI in which the value of the precedence digit signifies a call priority greater than 'routine'.	Immediate
1	SIP-004490	Changed "AS-SIP EI" to AS-SIP EI with P&P.	Immediate
1	SIP-004500	Changed "AS-SIP EI" to AS-SIP EI with P&P.	Immediate
1	SIP-004510	Changed "AS-SIP EI" to AS-SIP EI with P&P.	Immediate
1	SIP-004520	Changed "AS-SIP EI" to AS-SIP EI with P&P.	Immediate
1	SIP-004530	Changed "AS-SIP EI" to AS-SIP EI with P&P.	Immediate
1	SIP-004530.a	Changed "AS-SIP EI" to AS-SIP EI with P&P.	Immediate
1	SIP-004530.b	Changed "AS-SIP EI" to AS-SIP EI with P&P.	Immediate
1	SIP-004540	Changed "AS-SIP EI" to AS-SIP EI with P&P.	Immediate
1	SIP-004550	Changed "AS-SIP EI" to AS-SIP EI with P&P.	Immediate
1	SIP-004560	Changed "AS-SIP EI" to AS-SIP EI with P&P.	Immediate
1	SIP-004570	Changed "AS-SIP EI" to AS-SIP EI with P&P.	Immediate
1	SIP-004580	Changed "AS-SIP EI" to AS-SIP EI with P&P.	Immediate
1	SIP-004610, SIP-004630	Clarified requirement to include "to support the ability to generate and to receive/process".	Immediate

ERRATA #	REQ-ID	CORRECTION	EFFECTIVE DATE
1	SIP-004635	Added requirement when an RO AS-SIP EI receives a Request with a Require heading having a “resource-priority” option tag.	Immediate
1	SIP-004660	Specified [Required: AS-SIP EIs with P&P].	Immediate
1	SIP-004660.a	Specified [Required: AS-SIP EIs with P&P].	Immediate
1	SIP-004660.b	Specified [Required: AS-SIP EIs with P&P].	Immediate
1	SIP-004660.c	Specified [Required: AS-SIP EIs with P&P].	Immediate
1	SIP-004670	Specified [Required: AS-SIP EIs with P&P].	Immediate
1	SIP-004670.a	Specified [Required: AS-SIP EIs with P&P].	Immediate
1	SIP-004670.b	Specified [Required: AS-SIP EIs with P&P].	Immediate
1	SIP-004670.c	Specified [Required: AS-SIP EIs with P&P].	Immediate
1	SIP-004720	Changed “AS-SIP EI” to AS-SIP EI with P&P.	Immediate
1	SIP-004730.a	Changed “AS-SIP EI” to AS-SIP EI with P&P.	Immediate
1	SIP-004780	Specified [Required: AS-SIP EIs with P&P].	Immediate
1	SIP-004820	Changed “AS-SIP EI” to AS-SIP EI with P&P.	Immediate
1	SIP-004820.a	Changed “AS-SIP EI” to AS-SIP EI with P&P.	Immediate
1	SIP-004860	Specified [Required: AS-SIP EIs with P&P].	Immediate
1	SIP-005010.a	Clarified behavior of a proprietary IP EI and RO AS-SIP EI.	Immediate
1	SIP-005010.b	Clarified requirement is for an EI that support endpoint preemption.	Immediate
1	SIP-005010.c	Clarified requirement is for an EI that support endpoint preemption.	Immediate
1	SIP-005010.c.2	Clarified to describe different types of EIs.	Immediate
1	SIP-005020	Changed “AS-SIP EI” to AS-SIP EI with P&P.	Immediate
1	SIP-005100	Specified [Required: AS-SIP EIs with P&P].	Immediate
1	SIP-005110	Specified [Required: AS-SIP EIs with P&P].	Immediate
1	SIP-005120	Clarified to describe different types of EIs.	Immediate
1	SIP-005150	Clarified to describe different types of EIs.	Immediate
1	SIP-005190	Specified [Required: AS-SIP EIs with P&P].	Immediate
1	SIP-005210	Changed “AS-SIP EI” to AS-SIP EI with P&P.	Immediate
1	SIP-005230	Changed “AS-SIP EI” to AS-SIP EI with P&P.	Immediate
1	SIP-005240.b	Changed “AS-SIP EI” to AS-SIP EI with P&P.	Immediate
1	SIP-005240.c	Clarified to describe different types of EIs.	Immediate
1	SIP-005250	Specified [Required: AS-SIP EIs with P&P].	Immediate
1	SIP-005250.a	Specified [Required: AS-SIP EIs with P&P].	Immediate
1	SIP-005250.b	Specified [Required: AS-SIP EIs with P&P].	Immediate
1	SIP-005250.c	Specified [Required: AS-SIP EIs with P&P]. Clarified to describe different types of EIs.	Immediate
1	SIP-005250.d	Specified [Required: AS-SIP EIs with P&P].	Immediate
1	SIP-005250.e	Specified [Required: AS-SIP EIs with P&P].	Immediate
1	SIP-005260	Clarified to describe different types of EIs.	Immediate
1	SIP-005260.b	Changed “AS-SIP EI” to AS-SIP EI with P&P.	Immediate
1	SIP-005260.c	Clarified to describe different types of EIs.	Immediate
1	SIP-005270	Specified [Required: AS-SIP EIs with P&P].	Immediate

ERRATA #	REQ-ID	CORRECTION	EFFECTIVE DATE
1	SIP-005270.a	Specified [Required: AS-SIP EIs with P&P].	Immediate
1	SIP-005270.b	Specified [Required: AS-SIP EIs with P&P]. Changed “AS-SIP EI” to AS-SIP EI with P&P.	Immediate
1	SIP-005270.c	Specified [Required: AS-SIP EIs with P&P]. Clarified to describe different types of EIs.	Immediate
1	SIP-005270.d	Specified [Required: AS-SIP EIs with P&P].	Immediate
1	SIP-005270.e	Specified [Required: AS-SIP EIs with P&P].	Immediate
1	SIP-005280.b	Changed “AS-SIP EI” to AS-SIP EI with P&P.	Immediate
1	SIP-005280.c	Clarified to describe different types of EIs.	Immediate
1	SIP-005280.d	Clarified to describe different types of EIs.	Immediate
1	SIP-005290	Specified [Required: AS-SIP EIs with P&P].	Immediate
1	SIP-005290.a	Specified [Required: AS-SIP EIs with P&P].	Immediate
1	SIP-005290.b	Specified [Required: AS-SIP EIs with P&P]. Changed “AS-SIP EI” to AS-SIP EI with P&P.	Immediate
1	SIP-005290.c	Clarified to describe different types of EIs.	Immediate
1	SIP-005290.d	Specified [Required: AS-SIP EIs with P&P]. Clarified to describe different types of EIs.	Immediate
1	SIP-005300.a	Clarified to describe different types of EIs.	Immediate
1	SIP-005310.a	Clarified to describe different types of EIs.	Immediate
1	SIP-005320.a	Clarified to describe different types of EIs.	Immediate
1	SIP-005330.a	Changed “AS-SIP EI” to AS-SIP EI with P&P.	Immediate
1	SIP-005380.b	Clarified to describe different types of EIs.	Immediate
1	SIP-005380.c	Clarified to describe different types of EIs.	Immediate
1	SIP-005390.b	Clarified to describe different types of EIs.	Immediate
1	SIP-005390.c	Clarified to describe different types of EIs.	Immediate
1	SIP-005400.b	Clarified to describe different types of EIs.	Immediate
1	SIP-005400.c	Changed “AS-SIP EI” to AS-SIP EI with P&P.	Immediate
1	SIP-005400.d	Clarified to describe different types of EIs.	Immediate
1	SIP-006360	Changed “AS-SIP EI” to AS-SIP EI with P&P.	Immediate
1	SIP-009900	Clarified to describe different types of EIs.	Immediate
1	SIP-010070.d	Clarified to describe different types of EIs.	Immediate
1	SIP-010080	Specified [Required: AS-SIP EIs with P&P].	Immediate
1	SIP-010080.a	Specified [Required: AS-SIP EIs with P&P].	Immediate
1	SIP-010080.b.3	Specified [Required: AS-SIP EIs with P&P].	Immediate
1	SIP-010080.b.3.b	Specified [Required: AS-SIP EIs with P&P]. Clarified to describe different types of EIs.	Immediate
1	SIP-010090.d	Clarified to describe different types of EIs.	Immediate
1	SIP-010100	Specified [Required: AS-SIP EIs with P&P].	Immediate
1	SIP-010100.a	Specified [Required: AS-SIP EIs with P&P].	Immediate
1	SIP-010100.c	Specified [Required: AS-SIP EIs with P&P].	Immediate
1	SIP-010100.c.1	Specified [Required: AS-SIP EIs with P&P]. Clarified to describe different types of EIs.	Immediate
1	SIP-010110.d	Clarified to describe different types of EIs.	Immediate
1	SIP-010120	Specified [Required: AS-SIP EIs with P&P].	Immediate

ERRATA #	REQ-ID	CORRECTION	EFFECTIVE DATE
1	SIP-010120.a	Specified [Required: AS-SIP EIs with P&P].	Immediate
1	SIP-010120.a.1	Specified [Required: AS-SIP EIs with P&P].	Immediate
1	SIP-010120.a.2	Specified [Required: AS-SIP EIs with P&P].	Immediate
1	SIP-010120.c	Specified [Required: AS-SIP EIs with P&P].	Immediate
1	SIP-010120.c.1	Specified [Required: AS-SIP EIs with P&P].	Immediate
1	SIP-010160.a	Clarified to describe different types of EIs.	Immediate
1	SIP-010200.c	Clarified to describe different types of EIs.	Immediate
1	SIP-010240.c	Clarified to describe different types of EIs.	Immediate
1	SIP-010280.c	Clarified to describe different types of EIs.	Immediate

TABLE OF CONTENTS

<u>SECTION</u>	<u>PAGE</u>
Section 1 Introduction.....	1-1
1.1 Purpose.....	1-1
1.2 Scope.....	1-1
1.2.1 SBU and Classified Requirements.....	1-1
1.3 Applicability	1-2
1.4 UCR 2013 Document suite	1-2
1.5 Applicable Standards	1-3
1.6 Specification Language and Syntax.....	1-3
1.7 General Requirement Language	1-3
1.7.1 Product Applicability.....	1-4
1.7.1.1 Minimum Requirements	1-4
1.7.1.2 Optional Requirements	1-4
1.8 Definitions.....	1-4
Section 2 Signaling Design.....	2-1
Section 3 Calling Path Reference Cases	3-1
Section 4 SIP Requirements for AS-SIP Signaling Appliances and AS-SIP EIs.....	4-1
4.1 Introduction.....	4-1
4.1.1 SCs Serving AS-SIP EIs	4-2
4.1.2 SCs Serving IP EIs Other Than AS-SIP EIs.....	4-3
4.1.3 Basic Requirements	4-4
4.1.4 Failure To Establish TLS Connection.....	4-7
4.1.5 Vacant Code Treatment	4-9
4.1.6 Early Media.....	4-12
4.1.6.1 Early Media and Empty INVITE.....	4-15
4.1.6.2 Interworking Early Media to the TDM Network.....	4-16
4.1.7 Media Feature Tags.....	4-16
4.1.8 P-Asserted-Identity	4-17
4.2 SIP Methods.....	4-17
4.2.1 INVITE Request	4-17
4.2.2 CANCEL Request.....	4-17
4.2.3 REGISTER Request.....	4-17
4.2.3.1 AS-SIP EI Creation of Register Request	4-17
4.2.3.2 Registrar Processing of Register Request	4-20
4.2.4 OPTIONS Request.....	4-23

4.2.5	BYE Request.....	4-23
4.2.6	ACK Request	4-23
4.2.7	PRACK Request	4-23
4.2.8	UPDATE Request.....	4-23
4.2.9	REFER Request	4-24
4.2.10	SUBSCRIBE Request.....	4-24
4.2.11	NOTIFY Request.....	4-24
4.2.12	SIP INFO Method	4-24
4.3	SIP Header Fields	4-25
4.3.1	SC Header Requirements.....	4-36
4.3.1.1	Referred-By Header	4-37
4.3.1.2	Route Header – SC.....	4-37
4.3.1.3	Route Header – Softswitch	4-38
4.3.1.4	Route Header – SC (Classified Network Only).....	4-39
4.3.1.5	Route Header – Tier0 SS (Classified Network Only).....	4-41
4.3.1.6	“CCA-ID” Parameter for Contact Header	4-43
4.3.1.7	Via Header – Rules for SIP Proxy	4-44
4.3.1.8	Via Header – Rules for B2BUA	4-45
4.3.1.9	Via Header – Rules for SC Acting as UAC/UAS on Behalf of the IP EI.....	4-46
4.3.1.10	Via Header – Rules for AS-SIP EI	4-46
4.3.2	AS-SIP EI Header Requirements.....	4-46
4.3.2.1	Referred-By Header	4-47
4.3.2.2	Tags.....	4-47
4.4	SIP Response Codes	4-47
4.4.1	SCs Serving AS-SIP EIs	4-47
4.4.2	AS-SIP EIs.....	4-51
4.4.3	SCs Serving SIP EIs.....	4-52
4.4.4	SCs Serving H.323 and/or Proprietary IP EIs.....	4-55
4.5	Precondition	4-57
4.5.1	SBU Network.....	4-57
4.5.2	Classified Network.....	4-59
4.5.2.1	“Optional” Strength-Tag.....	4-59
4.5.2.2	“Mandatory” Strength-Tag	4-60
4.6	SIP URI and Mapping of Telephone Number Into SIP URI	4-61
4.6.1	DSN Numbers.....	4-61
4.6.2	N11 Service Codes.....	4-66
4.6.3	PSTN Numbers	4-67

4.6.4	Example Request-URI Fields	4-71
4.7	64 Kbps Transparent Calls (Clear Channel)	4-72
4.8	Transport of Route Code Information Over AS-SIP	4-73
4.9	Confidentiality Access Level General Requirements	4-75
4.9.1	CAL Header	4-75
4.9.1.1	mode-param Field	4-76
4.9.2	Presence of CAL Header in INVITE Requests, 200 Responses, 418 Responses.....	4-77
4.9.3	AS-SIP EIs and SIP EIs Do NOT Generate CAL Header	4-78
4.9.4	Generating the CAL Header – SC	4-79
4.9.5	Confidential-Access-Level Option Tag	4-80
4.9.6	(Incompatible CAL) Response	4-80
4.9.7	CAL Header Processing.....	4-81
4.9.7.1	INVITE	4-81
4.9.7.2	Response	4-82
4.9.8	Example of CAL Header Traversing the Signaling Path.....	4-85
4.10	Session Keep-Alive Timer	4-87
4.10.1	AS-SIP Signaling Appliances	4-87
4.10.2	AS-SIP EIs	4-88
Section 5	Session Description Protocol	5-1
5.1	Session Description.....	5-1
5.2	Session-Level Description	5-2
5.2.1	Protocol Version (“v=”) Line.....	5-2
5.2.2	Origin (“o=”) Line	5-2
5.2.3	Session Name (“s=”) Line	5-3
5.2.4	Time (“t=”) Line	5-4
5.2.5	Clarification on the Use of ANAT for Related Media Streams.....	5-4
5.3	Media Description.....	5-6
5.3.1	Media (“m=”) Field	5-6
5.3.2	Connection Data (“c=”) Field	5-7
5.3.3	Attributes (“a=”) Fields	5-8
5.3.4	Bandwidth (“b=”) Field	5-9
5.3.5	Bandwidth Modifier Application Rules.....	5-10
5.4	SDP Parameters for Video Codecs	5-11
5.4.1	H.261 Codec Parameters.....	5-11
5.4.2	H.263 Codec Parameters.....	5-13
5.4.2.1	H.263-1998 Optional Parameters.....	5-14
5.4.2.2	Support for Optional Annexes	5-16

5.4.2.3	Other Optional Parameters.....	5-17
5.4.2.4	H.263-2000 Optional Parameters.....	5-17
5.4.2.5	H.263 SDP Offer Answer Rules.....	5-19
5.4.3	H.264 Codec Parameters.....	5-20
5.4.3.1	SDP Offer/Answer Rules for H.264 Optional Parameters	5-25
5.4.3.2	Interaction of H.264 OPTIONAL Parameter Capability Exchange and Direction Attribute	5-26
5.4.3.3	Miscellaneous H.264 Capability Exchange Rules	5-27
5.5	SDP Offer/Answer Exchange	5-27
5.6	Additional Offer/Answer Rules for AS-SIP Video	5-28
5.6.1	Generating the Initial Offer.....	5-28
5.6.2	Generating the Answer	5-28
5.6.3	Offeror Processing of the Answer.....	5-28
5.7	SDP Examples	5-29
5.7.1	Basic SDP Exchange.....	5-29
Section 6 Precedence and Preemption		6-1
6.1	Precedence Level Communicated Over SIP Signaling.....	6-1
6.1.1	Resource-Priority Header Field	6-1
6.1.1.1	Namespace	6-2
6.1.1.2	Configuring the Set of Network-Domain Values To Be Received and Recognized by an AS-SIP Signaling Appliance or AS-SIP EI <u>with P&P</u>	6-2
6.1.1.3	Configuring the Network-Domain Value To Be Generated by an AS-SIP Signaling Appliance or AS-SIP EI <u>with P&P</u>	6-3
6.1.1.4	r-priority.....	6-5
6.1.1.5	Classified Only Requirement.....	6-6
6.1.2	Requirements for SCs Serving IP EIs.....	6-6
6.1.2.1	SIP Message Without Resource-Priority Header Received From Served <u>AS-SIP EI or</u> SIP EI.....	6-6
6.1.2.2	SIP Message With Resource-Priority Header Received From Served AS-SIP EI or SIP End Instrument.....	6-7
6.1.2.3	Call Request Received From Served H.323 or Proprietary IP EI.....	6-11
6.1.2.4	AS-SIP Message With Resource-Priority Header for Served IP EI	6-12
6.1.3	Option Tag “resource-priority”	6-12
6.1.4	Error Conditions.....	6-13
6.1.4.1	SC Serving IP EI: Improper Network-Domain, Priority Value, or Precedence-Domain	6-13
6.1.4.2	AS-SIP IP EI: Improper Network-Domain, Priority Value, or Precedence-Domain	6-14

6.1.4.3	Originating SS: Improper Network-Domain, Priority Value, or Precedence-Domain	6-15
6.1.4.4	Terminating SS: Improper Network-Domain, Priority Value, or Precedence-Domain	6-16
6.1.4.5	Authentication Failure	6-18
6.1.4.6	Authorization Failure	6-19
6.1.4.7	Insufficient Resources.....	6-20
6.1.4.8	Re-INVITE With Different Resource-Priority Header.....	6-23
6.2	Precedence Call Rules.....	6-24
6.2.1	AS Precedence Capability and Call Forwarding	6-25
6.3	Call Origination Busy	6-27
6.4	ASAC Preemption Requirements	6-29
6.4.1	Reason Header for Preemption	6-29
6.4.2	Preemption at the IP EI.....	6-31
6.4.2.1	General Preemption Rules for Behavior at IP EIs	6-31
6.4.2.2	Required Behavior at Called IP EI When Active Call Is Preempted by Higher Precedence Call Request.....	6-36
6.4.2.3	Implementing Preemption on Behalf of Called IP EIs	6-38
6.4.3	Network Preemption	6-47
6.4.3.1	Circumstances Under Which an SC Performs Network Preemption....	6-47
6.4.3.2	Implementing the Network Preemption.....	6-50
6.5	ASAC Rule Set	6-53
6.5.1	SC Component of SS	6-54
6.5.2	Empty INVITE.....	6-54
6.5.3	SC.....	6-55
6.5.3.1	Outbound INVITE and re-INVITE.....	6-55
6.5.3.2	Inbound INVITE and re-INVITE	6-57
6.5.4	Softswitch	6-60
6.5.4.1	Outbound INVITE and re-INVITE.....	6-60
6.5.4.2	Inbound INVITE and re-INVITE	6-62
Section 7	SS Policing of Call Count Thresholds	7-1
7.1	Introduction.....	7-1
7.2	Policing of Telephony Calls and Call Requests.....	7-1
7.2.1	Policing of Outbound Telephony Call Requests.....	7-2
7.2.1.1	Outbound INVITE and re-INVITE.....	7-2
7.2.2	Policing of Inbound Telephony Call Requests	7-4
7.2.2.1	Inbound INVITE With sdp	7-4
7.2.2.2	Inbound Empty INVITE	7-6

7.2.2.3	Inbound re-INVITE	7-11
7.2.3	Notification to the NMS.....	7-13
7.2.4	Operational Adjustments	7-14
7.3	Policing of Video Sessions and Session Requests.....	7-14
7.3.1	Policing of Outbound Video Session Requests	7-15
7.3.2	Policing of Inbound Video Session Requests	7-17
7.3.2.1	Inbound INVITE.....	7-17
7.3.2.2	Inbound re-INVITE	7-21
7.3.3	Notification to the NMS.....	7-24
7.3.4	Operational Adjustments	7-25
Section 8	Video Telephony – General Rules.....	8-1
8.1	Caller.....	8-1
8.2	Callee	8-2
8.3	IP-to-IP Video Telephony Call Flows	8-3
8.3.1	INVITE With sdp Video Offer Accepted in 200 Response With sdp Answer	8-5
8.3.1.1	INVITE With sdp Video Offer Accepted in 200 Response With sdp Answer (AS-SIP EI)	8-6
8.3.2	INVITE With sdp Video Offer – Called Party Accepts Video After 200 Response	8-7
8.3.2.1	INVITE With sdp Video Offer – Called Party Accepts Video After 200 Response (AS-SIP EI).....	8-11
8.3.3	Empty INVITE – Caller Requests Video; Called Party Offers Video (Media Feature Tags NOT Used)	8-12
8.3.3.1	Empty INVITE – Caller Requests Video; Called Party Offers Video (Media Feature Tags NOT Used) – AS-SIP EI Receives Empty INVITE	8-15
8.3.4	Empty INVITE – Caller Requests Video; Called Party Offers Audio; Caller Again Requests Video (Media Feature Tags NOT Used).....	8-16
8.3.4.1	Empty INVITE – Caller Requests Video; Called Party Offers Audio; Caller Again Requests Video (Media Feature Tags NOT Used) (AS- SIP EI Receives Empty INVITE)	8-19
8.3.5	Empty INVITE – Caller Requests Video; Called party Offers Video (Media Feature Tags Used by Originating SC and Terminating SC).....	8-20
8.3.5.1	Empty INVITE – Caller Requests Video; Called Party Offers Video (Media Feature Tags Used by Originating SC and Terminating SC) – AS-SIP EI Receives Empty INVITE	8-23
8.3.6	Empty INVITE – Caller Requests Video; Called Party Offers Audio – Calling Party Again Requests Video (Media Feature Tags Used by Originating SC and Terminating SC)	8-24
8.4	Point-to-Point Video Conference Unit Call Flows	8-28

8.4.1	VCU INVITE With sdp Video Offer.....	8-28
8.4.1.1	VCU INVITE With sdp Video Offer (AS-SIP VCU EI).....	8-29
8.4.2	VCU Empty INVITE (Media Feature Tags NOT Used).....	8-30
8.4.2.1	VCU Empty INVITE (Media Feature Tags NOT Used) – AS-SIP VCU EIs.....	8-32
8.4.3	VCU Empty INVITE (Media Feature Tags Used by Originating SC and Terminating SC).....	8-33
8.4.3.1	VCU Empty INVITE (Media Feature Tags Used) – AS-SIP VCU EIs.....	8-35
Section 9 Calling Services		9-1
9.1	Introduction.....	9-1
9.2	Point-to-Point Call	9-1
9.2.1	IP-to-IP Call Type.....	9-2
9.2.1.1	Successful Basic IP-to-IP Call (No Reliable Provisional Responses, No Preconditions)	9-2
9.2.1.2	Successful Basic IP to IP Call (End-to-End Precondition).....	9-4
9.2.1.3	Successful Basic IP to IP Call (Segmented Precondition).....	9-6
9.3	Call Hold.....	9-8
9.3.1	IP-to-IP Call Type.....	9-8
9.3.1.1	Successful Basic IP-to-IP Call Hold (AS-SIP EI)	9-13
9.3.2	[Conditional] Music on Hold.....	9-14
9.3.2.1	IP-to-IP Call Type.....	9-14
9.4	Call Waiting.....	9-25
9.4.1	IP-to-IP Call Type.....	9-25
9.4.1.1	Successful Basic IP-to-IP Call Waiting (AS-SIP EI)	9-28
9.5	Call Forward	9-30
9.5.1	Call Forward (Unconditional).....	9-30
9.5.1.1	IP-to-IP Call Type.....	9-30
9.5.2	Call Forward (No Answer)	9-36
9.5.2.1	IP-to-IP Call Type.....	9-37
9.5.3	Call Forward (Busy)	9-43
9.5.3.1	IP-to-IP Call Type.....	9-43
9.6	Call Transfer	9-50
9.6.1	Call Transfer Modes	9-50
9.6.2	Unattended Transfer – Call Transferor: SIP	9-50
9.6.2.1	Unattended Call Transfer for IP EIs (REFER Method).....	9-51
9.6.2.2	Unattended Call Transfer for IP EIs (INVITE and re-INVITE Method).....	9-56
9.6.3	Attended Transfer – Call Transferor: SIP	9-59

9.6.3.1	Attended Call Transfer for IP EIs (REFER Method).....	9-59
9.6.3.2	Attended Call Transfer for IP EI (INVITE and re-INVITE Method)....	9-68
9.7	Three-Way Audio Call.....	9-71
9.7.1	Three-Way Audio Call Performed by EI.....	9-72
9.7.1.1	Precedence and Preemption Rule for Three-Way Audio Calls at EI....	9-72
9.7.1.2	Proprietary IP EI (i.e., non-AS-SIP EI) Provides Focus for Three- Way Audio Call	9-74
9.7.1.3	AS-SIP EI Provides Focus for Three-Way Audio Call	9-76
9.7.2	Three-Way Audio Call Performed by SC on Behalf of Served Proprietary EI w/i SC SUT	9-78
9.7.2.1	Precedence and Preemption Rule for Three-Way Audio Calls at SC....	9-79
9.7.2.2	Refer Method for Three-Way Call at SC.....	9-79
9.7.2.3	Re-INVITE Method for Three-Way Call at SC.....	9-82
Section 10	Audio and Video Conference Services	10-1
10.1	Audio Conference Servers and Video Conference Servers	10-1
10.1.1	SC (or SS)-Conference Server Configurations	10-1
10.1.2	Precedence and Preemption Rules for Audio and Video Conference Servers.....	10-2
10.1.3	Definitions of Terms	10-2
10.1.4	EI Requirements Related to Audio Conferencing	10-3
10.2	Audio Conferencing.....	10-3
10.2.1	Ad Hoc Audio Conference.....	10-3
10.2.1.1	Call Flow Diagrams	10-5
10.2.2	Reservationless Audio Conference	10-19
10.2.2.1	Call Flow Diagrams	10-22
10.2.3	Scheduled Audio Conference	10-34
10.2.3.1	Call Flow Diagrams	10-35
10.3	Videoconference Requirements	10-45
10.3.1	Videoconference EIs.....	10-45
10.3.2	Audio and Video Codecs	10-47
10.3.3	Role-Based Video Stream (RBVS).....	10-48
10.3.3.1	Assignment of Roles to Media Streams.....	10-48
10.3.3.2	Negotiating RBVS Capabilities Between AS-SIP Videoconference EIs (RBVS-Compliant SIP Videoconference EIs) and AS-SIP Videoconference Servers	10-50
10.3.3.3	Managing Control of “slides” Video Stream Using BFCP.....	10-60
10.3.4	Video Channel Flow Control.....	10-67
10.3.5	Video Channel Fast Update Requests.....	10-70
10.3.6	Far End Camera Control (FECC)	10-72

10.3.6.1	General H.224 Control Channel for Far-End Camera Control Messages	10-73
10.3.6.2	Far End Camera Control – ITU-T H.281	10-74
10.3.7	Scheduled Videoconference	10-76
10.3.7.1	ASAC	10-78
10.3.7.2	Call Flow Diagrams	10-78
Section 11	Modem on IP Networks	11-1
11.1	AS-SIP Signaling Requirements in Support of Modem Relay-Capable Gateways	11-1
11.1.1	Advertisement of Modem Relay Capabilities in SDP Offer on Behalf of Modem Relay Capable Gateways	11-1
11.1.2	Advertisement of Modem Relay Capabilities in SDP Answer on Behalf of Modem Relay Capable Gateways	11-7
11.2	AS-SIP Signaling Requirements in Support of UC SCIP EIs	11-13
11.2.1	UC SCIP EI Advertisement of Modem Relay Capabilities in SDP Offer	11-13
11.2.2	UC SCIP EI Advertisement of Modem Relay Capabilities in SDP Answer	11-18
Section 12	TDM – SIP Translation Requirements for Inter-Working AS-SIP Signaling Appliances	12-1
12.1	Introduction	12-1
12.1.1	TDM-to-TDM Calls Over IP Backbone	12-1
12.1.2	TDM-to-IP Calls Over an IP Backbone	12-5
12.1.3	5.3.4.14.1.3 IP-to-TDM Calls Over an IP Backbone	12-8
12.2	Summary Description of the Three Call Types	12-10
12.2.1	TDM Bridging	12-10
12.2.2	TDM-to-IP Call	12-10
12.2.3	IP-to-TDM Call	12-11
12.3	SIP URI and Mapping of Telephony Number Into SIP URI	12-11
12.4	General Requirements for Interworking AS-SIP Signaling Appliances	12-12
12.5	ISUP Versions	12-12
12.5.1	Encapsulation of ISUP Messages in AS-SIP Requests/Responses	12-13
12.5.2	De-Encapsulation of ISUP Messages From AS-SIP Requests/Responses ...	12-13
12.5.3	ISUP Messages That Are Never Encapsulated	12-13
12.5.4	Tones	12-13
12.6	Translation Requirements for an Inter-working AS-SIP Signaling Appliance Operating as an Originating Gateway	12-14
12.6.1	General Requirements (Originating Gateway)	12-14
12.6.2	TDM Bridging Call Flow and TDM-IP Call Flow Requirements (Originating Gateway)	12-14
12.6.2.1	Originating Gateway Sends AS-SIP INVITE	12-14

12.6.2.2	Originating Gateway Maps ISUP IAM Parameters to AS-SIP INVITE Headers	12-15
12.6.2.3	Originating Gateway Maps ISUP Messages to AS-SIP Messages.....	12-20
12.6.2.4	Autonomous Release by Originating Gateway.....	12-22
12.6.2.5	Originating Gateway Maps AS-SIP Messages to ISUP Messages.....	12-23
12.7	Translation Requirements for an Interworking AS-SIP Signaling Appliance Operating as a terminating Gateway.....	12-26
12.7.1	General Requirements.....	12-26
12.7.2	TDM Bridging and IP-to-TDM Call Flow Requirements (Terminating Gateway).....	12-26
12.7.2.1	Terminating Gateway Receives AS-SIP INVITE.....	12-26
12.7.2.2	Terminating Gateway Maps AS-SIP INVITE Headers to ISUP IAM Parameters.....	12-28
12.7.2.3	Terminating Gateway Maps ISUP Messages to AS-SIP Messages.....	12-38
12.7.2.4	Terminating Gateway Maps AS-SIP Messages to ISUP Messages	12-42
12.7.2.5	ISUP Messages That Are Encapsulated by Terminating Gateway for Transparent Transport.....	12-43
12.7.2.6	Autonomous Release of Call by Terminating Gateway	12-43
Section 13	Relevant Timers for the Terminating GW and Originating GW	13-1
13.1	ISUP Timers.....	13-1
13.2	SIP Timers	13-2
Section 14	SIP Requirements for Inter-Working AS-SIP Signaling Appliances	14-1
14.1	General Requirements.....	14-1
14.2	Methods.....	14-1
14.2.1	INVITE	14-1
14.2.2	CANCEL.....	14-1
14.2.3	REGISTER	14-2
14.2.4	OPTIONS.....	14-2
14.2.5	BYE.....	14-2
14.2.6	ACK.....	14-2
14.2.7	INFO	14-2
14.2.8	PRACK	14-2
14.2.9	UPDATE.....	14-2
14.2.10	REFER.....	14-3
14.2.11	SUBSCRIBE.....	14-3
14.2.12	NOTIFY	14-3
14.3	Header Fields	14-3
14.3.1	Route Header	14-4
14.3.2	Interworking AS-SIP Signaling Appliance and VIA Header Requirements..	14-6

14.3.3	“CCA-ID” Parameter	14-6
14.4	Response Codes	14-6
14.5	SIP Preconditions.....	14-7
14.6	Kbps Transparent Calls (Clear Channel)	14-7
14.7	Transport of Route Code Information Over AS-SIP	14-7
14.8	Keep-Alive Timer Requirements for Interworking AS-SIP Signaling Appliances.....	14-8
Section 15 Precedence and Preemption Extensions for Interworking AS-SIP Signaling		
	Appliances	15-1
15.1	Precedence Level Communicated Over SIP Signaling.....	15-1
15.1.1	“Resource-Priority” Header Field.....	15-1
15.1.2	Namespace	15-1
15.1.3	r-priority.....	15-1
15.2	Requirements for Inter-working AS-SIP Signaling Appliances.....	15-1
15.2.1	Call Request Received From SS7 Network.....	15-1
15.2.2	Call Request Intended for the SS7 Network	15-2
15.3	Option Tag “resource-priority”	15-3
15.4	Error Conditions.....	15-3
15.4.1	Improper Network-Domain, Priority Value, or Precedence-Domain	15-3
15.4.2	Authentication Failure	15-5
15.4.3	Authorization Failure	15-5
15.4.4	Insufficient Resources.....	15-5
15.5	Precedence Call Rules.....	15-5
15.6	ASAC Preemption Requirements	15-5
15.6.1	Reason Header for Preemption	15-6
15.6.2	Preemption at the IP EI.....	15-6
15.6.2.1	General Preemption Rules for Behavior at IP EIs	15-6
15.6.2.2	Interworking Signaling for BPA and BNEA	15-6
15.6.2.3	Required Behavior at Called IP EI When Active Call Is Preempted by Higher Precedence Call Request.....	15-7
15.6.2.4	Implementing Preemption on Behalf of Called IP EIs	15-7
15.6.3	Network Preemption	15-13
15.6.3.1	Circumstances Under Which an Interworking AS-SIP Signaling Appliance Performs Network Preemption	15-14
15.6.3.2	Implementing the Network Preemption.....	15-14
Section 16 Supplementary Services.....		
16.1	Introduction.....	16-1
16.2	Point-to-Point Call	16-1
16.2.1	IP-to-IP Call Type.....	16-1

16.2.2	TDM Bridging Call Type.....	16-2
16.2.2.1	TDM Bridging Call Type (No Preconditions).....	16-2
16.2.2.2	TDM Bridging Call Type (Segmented Precondition).....	16-3
16.2.2.3	TDM Bridging Call Type (End-to-End Precondition).....	16-5
16.2.3	TDM-to-IP Call Type	16-8
16.2.3.1	TDM-to-IP Call Type (No Preconditions).....	16-8
16.2.3.2	TDM-to-IP Call Type (Segmented Precondition).....	16-9
16.2.3.3	TDM-to-IP Call Type (End-to-End Precondition).....	16-11
16.2.4	IP-to-TDM Call Type	16-13
16.2.4.1	IP-to-TDM Call Type (No Preconditions).....	16-13
16.2.4.2	IP-to-TDM Call Type (Segmented Precondition).....	16-15
16.2.4.3	IP-to-TDM Call Type (End-to-End Precondition).....	16-17
16.3	Call Hold.....	16-19
16.3.1	IP-to-IP Call Type.....	16-20
16.3.2	TDM Bridging Call Type.....	16-20
16.3.3	TDM-to-IP Call Type	16-20
16.3.4	IP-to-TDM Call Type	16-24
16.4	Call Waiting.....	16-28
16.4.1	IP-to-IP Call Type.....	16-28
16.4.2	TDM Bridging Call Type.....	16-28
16.4.3	TDM-to-IP Call Type	16-31
16.4.4	IP-to-TDM Call Type	16-38
16.5	Call Forward	16-44
16.5.1	Call Forward (Unconditional).....	16-44
16.5.1.1	IP-to-IP Call Type.....	16-44
16.5.1.2	TDM Bridging Call Type.....	16-45
16.5.1.3	TDM-to-IP Call Type	16-46
16.5.1.4	IP-to-TDM Call Type	16-48
16.5.2	Call Forward (No Answer)	16-50
16.5.2.1	IP-to-IP Call Type.....	16-50
16.5.2.2	TDM Bridging Call Type.....	16-50
16.5.2.3	TDM-to-IP Call Type	16-52
16.5.2.4	IP-to-TDM Call Type	16-54
16.5.3	Call Forward (Busy)	16-56
16.5.3.1	IP-to-IP Call Type.....	16-57
16.5.3.2	TDM Bridging Call Type.....	16-57
16.5.3.3	TDM-to-IP Call Type	16-58
16.5.3.4	IP-to-TDM Call Type	16-60

16.6	Call Transfer	16-62
16.6.1	Call Transfer Modes	16-62
16.6.2	Unattended Transfer – Call Transferor: TDM.....	16-63
16.6.3	Attended Call Transfer – Call Transferor: TDM.....	16-63
Section 17	Glossary of Abbreviations and Acronyms.....	17-1

LIST OF FIGURES

<u>FIGURE</u>	<u>PAGE</u>
Figure 1.4-1. UC 2013 Document Suite	1-3
Figure 2-1. Network-Level AS-SIP Signaling Design	2-1
Figure 3-1. IP-to-IP Calls Over an IP Backbone	3-1
Figure 4.1-1. SC Implements Playing of ICA at AS-SIP EI.....	4-8
Figure 4.1-2. SC Implements Playing of VCA at AS-SIP EI	4-10
Figure 4.1-3. Originating SC Implements Playing of VCA at AS-SIP EI Upon Receipt of 404 Response From Destination SC.....	4-11
Figure 4.6-1. Originating SC Implements Playing of VCA at AS-SIP EI When SC Is Unable To Create a Full 10-Digit DSN Number for the Userinfo Part of the Request-URI Field.....	4-63
Figure 4.6-2. Originating SC Implements Playing of VCA at AS-SIP EI When SC Is Unable To Create a Global E.164 Number for the Userinfo Part of the Request-URI Field	4-70
Figure 4.9-1. Example of CAL Session Establishment Using Variable Mode.....	4-85
Figure 6.1-1. SC/Media Server Plays UPA to AS-SIP EI <u>(with P&P)</u>	6-20
Figure 6.1-2. SC Implementation of BPA for AS-SIP EI on Receipt of 488 Response <u>(with P&P)</u>	6-21
Figure 6.1-3. SC Implementation of ICA for AS-SIP EI on Receipt of 503 Response.....	6-23
Figure 6.4-1. SC Implementation of BNEA for AS-SIP EI on Receipt of 480 Response	6-33
Figure 6.4-2. SC Implementation of BPA for AS-SIP EI on Receipt of 486, or 488 Response	6-34
Figure 6.4-3. SC Implementation of BPA for AS-SIP EI <u>with P&P</u> Because of Lack of Network Resources at SC Access Link	6-48
Figure 8.3-1. INVITE With sdp Video Offer Accepted in 200 Response With sdp Answer	8-5
Figure 8.3-2. INVITE With sdp Video Offer Accepted in 200 Response With sdp Answer (AS-SIP EI).....	8-7
Figure 8.3-3. INVITE With sdp Video Offer – Called Party Accepts Video After 200 Response	8-8
Figure 8.3-4. INVITE With sdp Offer – Called Party Accepts Video After 200 Response (AS-SIP EI).....	8-12
Figure 8.3-5. Empty INVITE – Caller Requests Video; Called Party Offers Video (Media Feature Tags NOT Used).....	8-13
Figure 8.3-6. Empty INVITE – Caller Requests Video; Called Party Offers Video (Media Feature Tags NOT Used) – AS-SIP EI Receives Empty INVITE	8-16

Figure 8.3-7.	Empty INVITE – Caller Requests Video; Called Party Offers Audio; Caller Again Requests Video (Media Feature Tags NOT Used).....	8-17
Figure 8.3-8.	Empty INVITE – Caller Requests Video; Called Party Offers Audio; Caller Again Requests Video (Media Feature Tags NOT Used) – AS-SIP EI Receives Empty INVITE.....	8-20
Figure 8.3-9.	Empty INVITE – Caller Requests Video; Called Party Offers Video (Media Feature Tags Used by Originating SC and Terminating SC).....	8-21
Figure 8.3-10.	Empty INVITE – Caller Requests Video; Called Party Offers Video (Media Feature Tags Used by Originating SC and Terminating SC).....	8-23
Figure 8.3-11.	Empty INVITE – Caller Requests Video; Called Party Offers Audio – Calling Party Again Requests Video (Media Feature Tags Used by Originating SC and Terminating SC).....	8-25
Figure 8.4-1.	VCU INVITE With sdp Video Offer.....	8-28
Figure 8.4-2.	VCU INVITE With sdp Video Offer (AS-SIP VCU EI).....	8-30
Figure 8.4-3.	VCU Empty INVITE (Media Feature Tags NOT Used).....	8-31
Figure 8.4-4.	VCU Empty INVITE (Media Feature Tags NOT Used) – AS-SIP EI.....	8-33
Figure 8.4-5.	VCU Empty INVITE (Media Feature Tags Used by Originating SC and Terminating SC).....	8-34
Figure 8.4-6.	VCU Empty INVITE (Media Feature Tags Used) – AS-SIP EI.....	8-35
Figure 9.2-1.	Successful Basic IP-to-IP Call (No Reliable Provisional Responses, No Preconditions).....	9-2
Figure 9.2-2.	Successful Basic IP-to-IP Call (No Reliable Provisional Responses, No Preconditions) (AS-SIP EIs).....	9-4
Figure 9.2-3.	Successful Basic IP-to-IP Call (End-to-End Precondition).....	9-5
Figure 9.2-4.	Successful Basic IP-to-IP Call (Segmented Precondition).....	9-7
Figure 9.3-1.	IP-to-IP Call Hold (All Populated INVITEs).....	9-9
Figure 9.3-2.	IP-to-IP Call Hold (Unpopulated Resume INVITE).....	9-11
Figure 9.3-3.	IP-to-IP Call Hold (AS-SIP EIs).....	9-13
Figure 9.3-4.	IP-to-IP Music on Hold (Populated INVITEs).....	9-15
Figure 9.3-5.	IP-to-IP Music on Hold (Populated INVITEs and Empty INVITEs).....	9-18
Figure 9.3-6.	IP-to-IP Music on Hold (AS-SIP EIs).....	9-22
Figure 9.4-1.	IP-to-IP Call Waiting.....	9-26
Figure 9.4-2.	IP-to-IP Call Waiting (AS-SIP EI).....	9-29
Figure 9.5-1.	IP-to-IP Call Forward (Unconditional).....	9-31
Figure 9.5-2.	Call Flow Between AS-SIP EI and SC Using Star Code To Unconditionally Call Forward to a DSN Phone Number.....	9-32
Figure 9.5-3.	Call Flow Between AS-SIP EI and SC Using Star Code To Deactivate an Unconditional Call Forward.....	9-34
Figure 9.5-4.	IP-to-IP Call Forward (Unconditional) (AS-SIP EI).....	9-36
Figure 9.5-5.	IP-to-IP Call Forwarding on No Answer.....	9-37

Figure 9.5-6.	Call Flow Between AS-SIP EI and SC Using Star Code To Call Forward on No Answer to a DSN Phone Number	9-39
Figure 9.5-7.	Call Flow Between AS-SIP EI and SC Using Star Code To Deactivate Call Forward on No Answer	9-41
Figure 9.5-8.	IP-to-IP Call Forwarding on No Answer (AS-SIP EI)	9-42
Figure 9.5-9.	IP-to-IP Call Forwarding Busy	9-44
Figure 9.5-10.	Call Flow Between AS-SIP EI and SC Using Star Code To Call Forward Busy to a DSN Phone Number	9-46
Figure 9.5-11.	Call Flow Between AS-SIP EI and SC Using Star Code To Deactivate Call Forward Busy	9-48
Figure 9.5-12.	IP-to-IP Call Forwarding Busy (AS-SIP EI).....	9-49
Figure 9.6-1.	Unattended Call Transfer for IP EIs (REFER Method).....	9-51
Figure 9.6-2.	Unattended Call Transfer for IP EIs (INVITE and re-INVITE Method).....	9-58
Figure 9.6-3.	Attended Call Transfer for IP EIs (REFER Method).....	9-60
Figure 9.6-4.	Attended Call Transfer for IP EI (INVITE and re-INVITE Method).....	9-70
Figure 9.7-1.	Endpoint Preemption of Three-Way Call	9-73
Figure 9.7-2.	Proprietary EI Provides Focus for Three-Way Call.....	9-75
Figure 9.7-3.	AS-SIP EI Provides Focus for Three-Way Call.....	9-77
Figure 9.7-4.	Three-Way Call at SC (REFER Method) (Steps 1–22)	9-80
Figure 9.7-5.	Three-Way Call at SC (REFER Method) (Steps 23–38)	9-81
Figure 9.7-6.	Three-Way Call at SC (RE-INVITE Method)	9-84
Figure 10.2-1.	Ad Hoc Conference – Conference Server Within SC SUT, Conference Initiator at Proprietary EI (Steps 1–4).....	10-7
Figure 10.2-2.	Ad Hoc Conference – Conference Server Within SC SUT, Conference Initiator at Proprietary EI (Steps 5–20).....	10-8
Figure 10.2-3.	Ad Hoc Conference – Conference Server Within SC SUT, Conference Initiator at Proprietary EI	10-9
Figure 10.2-4.	Ad Hoc Conference – Conference Server Within SC SUT, Conference Initiator at AS-SIP EI (Steps 1–15).....	10-10
Figure 10.2-5.	Ad Hoc Conference – Conference Server Within SC SUT, Conference Initiator at AS-SIP EI (Steps 16–31).....	10-11
Figure 10.2-6.	Ad Hoc Conference – Conference Server Within SC SUT, Conference Initiator at AS-SIP EI.....	10-12
Figure 10.2-7.	Ad Hoc Conference – AS-SIP Conference Server, Conference Initiator at Proprietary EI (Steps 1–15).....	10-13
Figure 10.2-8.	Ad Hoc Conference – AS-SIP Conference Server, Conference Initiator at Proprietary EI (Steps 16–39).....	10-15
Figure 10.2-9.	Ad Hoc Conference – AS-SIP Conference Server, Conference Initiator at Proprietary EI	10-15

Figure 10.2-10.	Ad Hoc Conference – AS-SIP Conference Server, Conference Initiator at AS-SIP EI (Steps 1–22).....	10-16
Figure 10.2-11.	Ad Hoc Conference – AS-SIP Conference Server, Conference Initiator at AS-SIP EI (Steps 23–42).....	10-17
Figure 10.2-12.	Ad Hoc Conference – AS-SIP Conference Server, Conference Initiator at AS-SIP EI (Steps 43–54).....	10-18
Figure 10.2-13.	Reservationless Conference – Conference Server Within SC SUT, Conference Chair at Proprietary EI (Steps 1–4)	10-23
Figure 10.2-14.	Reservationless Conference – Conference Server Within SC SUT, Conference Chair at Proprietary EI (Steps 5–20)	10-24
Figure 10.2-15.	Reservationless Conference – Conference Server Within SC SUT, Conference Chair at AS-SIP EI (Steps 1–8)	10-26
Figure 10.2-16.	Reservationless Conference – Conference Server Within SC SUT, Conference Chair at AS-SIP EI (Steps 9–28)	10-27
Figure 10.2-17.	Reservationless Conference – AS-SIP Conference Server, Conference Chair at Proprietary EI (Steps 1–24).....	10-29
Figure 10.2-18.	Reservationless Conference – AS-SIP Conference Server, Conference Chair at Proprietary EI (Steps 25–36).....	10-30
Figure 10.2-19.	Reservationless Conference – AS-SIP Conference Server, Conference Chair at Proprietary EI (Steps 1–24).....	10-32
Figure 10.2-20.	Reservationless Conference – AS-SIP Conference Server, Conference Chair at Proprietary EI (Steps 25–40).....	10-33
Figure 10.2-21.	Reservationless Conference – AS-SIP Conference Server, Conference Chair at Proprietary EI (Steps 41–48).....	10-34
Figure 10.2-22.	Scheduled Conference – Conference Server Within SC SUT, Host at Proprietary EI (Steps 1–4).....	10-37
Figure 10.2-23.	Scheduled Conference – Conference Server Within SC SUT, Host at Proprietary EI (Steps 5–20).....	10-38
Figure 10.2-24.	Scheduled Conference – Conference Server Within SC SUT, Host at AS-SIP EI (Steps 1–8)	10-39
Figure 10.2-25.	Scheduled Conference – Conference Server Within SC SUT, Host at AS-SIP EI (Steps 9–28)	10-40
Figure 10.2-26.	Scheduled Conference – AS-SIP Conference Server, Host at Proprietary EI (Steps 1–20).....	10-41
Figure 10.2-27.	Scheduled Conference – AS-SIP Conference Server, Host at Proprietary EI (Steps 21–36).....	10-42
Figure 10.2-28.	Scheduled Conference – AS-SIP Conference Server, Host at AS-SIP EI (Steps 1–16)	10-43
Figure 10.2-29.	Scheduled Conference – AS-SIP Conference Server, Host at AS-SIP EI (Steps 17–36)	10-44
Figure 10.2-30.	Scheduled Conference – AS-SIP Conference Server, Host at AS-SIP EI (Steps 37–48)	10-45

Figure 10.3-1.	SDP Negotiation for Establishing Videoconference Between AS-SIP Videoconference EIs (or RBVS-Compliant SIP Videoconference EIs) and AS-SIP Videoconference Server	10-54
Figure 10.3-2.	Scheduled Videoconference – Conference Server Within SC SUT (Steps 1–8)	10-80
Figure 10.3-3.	Scheduled Videoconference – Conference Server Within SC SUT (Steps 9–28)	10-81
Figure 10.3-4.	Scheduled Videoconference – Conference Server Within SC SUT (Steps 29–37)	10-82
Figure 10.3-5.	Scheduled Videoconference – AS-SIP Conference Server (Steps 1–16) ...	10-83
Figure 10.3-6.	Scheduled Videoconference – AS-SIP Conference Server (Steps 17–36)	10-84
Figure 10.3-7.	Scheduled Videoconference – AS-SIP Conference Server (Steps 37–54)	10-85
Figure 10.3-8.	Scheduled Videoconference – AS-SIP Conference Server (Steps 55–63)	10-86
Figure 12.1-1.	TDM-to-TDM Bridging Over an IP Backbone.....	12-2
Figure 12.1-2.	TDM-to-TDM Bridging From Enclave-to-Enclave.....	12-3
Figure 12.1-3.	TDM-to-TDM Bridging From Softswitch-to-SC.....	12-4
Figure 12.1-4.	TDM-to-TDM Bridging From SC-to-Softswitch.....	12-5
Figure 12.1-5.	TDM-to-IP Call Over an IP Backbone	12-6
Figure 12.1-6.	TDM-to-IP Call Translated at Originating Enclave.....	12-7
Figure 12.1-7.	IP-to-TDM Call Over an IP Backbone	12-8
Figure 12.1-8.	IP-to-TDM Call Translated at Destination Enclave.....	12-9
Figure 16.2-1.	Successful Basic TDM Bridging Call (No Preconditions)	16-2
Figure 16.2-2.	Successful Basic TDM Bridging Call (Segmented Precondition)	16-4
Figure 16.2-3.	Successful Basic TDM Bridging Call (End-to-End Precondition)	16-6
Figure 16.2-4.	Successful Basic TDM-to-IP Call (No Preconditions)	16-8
Figure 16.2-5.	Successful Basic TDM-to-IP Call (Segmented Precondition)	16-10
Figure 16.2-6.	Successful Basic TDM-to-IP Call (End-to-End Precondition)	16-12
Figure 16.2-7.	Successful Basic IP-to-TDM Call (No Preconditions)	16-14
Figure 16.2-8.	Successful Basic IP-to-TDM Call (Segmented Precondition).....	16-16
Figure 16.2-9.	Successful Basic IP-to-TDM Call (End-to-End Precondition)	16-18
Figure 16.3-1.	TDM Bridging Call Hold.....	16-21
Figure 16.3-2.	TDM-to-IP Call Hold; TDM Party Places Call on Hold.....	16-21
Figure 16.3-3.	TDM-to-IP Call Hold; IP Party Places Call on Hold.....	16-22
Figure 16.3-4.	TDM-SIP Call Hold; IP Party Places Call on Hold (AS-SIP Signaling to an AS-SIP EI Is Added for Illustrative Purposes).....	16-24
Figure 16.3-5.	IP-to-TDM Call Hold; IP Party Places Call on Hold.....	16-25

Figure 16.3-6.	AS-SIP-TDM Call Hold; AS-SIP EI Places Call on Hold (AS-SIP Signaling to an AS-SIP EI Is Added for Illustrative Purposes)	16-27
Figure 16.3-7.	IP-to-TDM Call Hold; TDM Party Places Call on Hold.....	16-28
Figure 16.4-1.	TDM Bridging Call Waiting	16-29
Figure 16.4-2.	TDM Bridging Call Waiting (AS-SIP Signaling to a Third-Party AS-SIP End Instrument Is Depicted for Illustrative Purposes)	16-31
Figure 16.4-3.	TDM-to-IP Call Waiting (Performed at IP Party B).....	16-32
Figure 16.4-4.	TDM-AS-SIP Call Waiting (Performed at AS-SIP EI B) (AS-SIP Signaling to AS-SIP EI B Is Depicted for Illustrative Purposes).....	16-35
Figure 16.4-5.	TDM-to-IP Call Waiting (Performed at TDM Party A)	16-36
Figure 16.4-6.	IP-to-TDM Call Waiting (Performed at TDM Party B).....	16-38
Figure 16.4-7.	IP-to-TDM Call Waiting (Performed at IP Party A).....	16-41
Figure 16.4-8.	AS-SIP-TDM Call Waiting (Performed at AS-SIP EI A) (AS-SIP Signaling to AS-SIP EI A Is Depicted for Illustrative Purposes)	16-44
Figure 16.5-1.	TDM Bridging Call Forward Unconditional (Call Forward Signaling Occurs Within ISUP Network)	16-45
Figure 16.5-2.	TDM-to-IP Call Forwarding	16-47
Figure 16.5-3.	IP-to-TDM Call Forwarding (Call Forward Signaling Occurs in ISUP Network)	16-49
Figure 16.5-4.	TDM Bridging Call Forwarding on No Answer	16-51
Figure 16.5-5.	TDM-to-IP Call Forwarding on No Answer.....	16-53
Figure 16.5-6.	IP-to-TDM Call Forwarding (No Answer)	16-55
Figure 16.5-7.	TDM Bridging Call Forwarding on Busy (Call Forward Signaling Occurs Within ISUP Network)	16-57
Figure 16.5-8.	TDM-to-IP Call Forwarding on Busy	16-59
Figure 16.5-9.	IP-to-TDM Call Forwarding on Busy	16-61
Figure 16.6-1.	Unattended Call Transfer (Transferor – TDM).....	16-63
Figure 16.6-2.	Attended Call Transfer Transferor – TDM	16-64

LIST OF TABLES

<u>TABLE</u>	<u>PAGE</u>	
Table 3-1.	Reference Case: IP-to-IP Calls Over an IP Backbone	3-2
Table 4.3-1.	Summary of Header Fields, A–Z (Part 1)	4-26
Table 4.3-2.	Summary of Header Fields, A–Z (Part 2)	4-29
Table 4.3-3.	IANA Registry Listing of Header Field Parameters	4-33
Table 4.8-1.	Route Code Digits Input by Caller and Corresponding “tgrp” “trunk-context”	4-73
Table 4.8-2.	“tgrp” and “trunk-context” Parameters Inserted for Hotline Calls	4-74

Table 4.8-3.	SIP tgrp to ISDN Q.931 Mapping.....	4-74
Table 5.4-1.	H263-1998 Optional Parameters and Their Permissible Values	5-14
Table 6.1-1.	r-priority Values Applicable to “UC” Network-Domain and “DSN” Network-Domain.....	6-5
Table 6.1-2.	r-priority Values.....	6-6
Table 6.1-3.	Announcements.....	6-11
Table 6.2-1.	UC Information Signals	6-25
Table 9.5-1.	Recall Dial Tone, Confirmation Tone, Reorder Tone.....	9-34
Table 11.1-1.	Payload and Window Sizes.....	11-6
Table 11.2-1.	ITU Recommendation V.150.1, Table E.2	11-17
Table 12.1-1.	Reference Case #1a – TDM-to-TDM Bridging Over an IP Backbone.....	12-2
Table 12.1-2.	Reference Case #1b – TDM-to-TDM Bridging From Enclave-to- Enclave.....	12-3
Table 12.1-3.	Reference Case #1c – TDM-to-TDM Bridging From Softswitch-to-SC.....	12-4
Table 12.1-4.	Reference Case #1d – TDM-to-TDM Bridging From SC-to-Softswitch.....	12-5
Table 12.1-5.	Reference Case #2a – TDM-to-IP Call Over an IP Backbone.....	12-6
Table 12.1-6.	Reference Case #2b – TDM-to-IP Call Translated at Originating Enclave.....	12-7
Table 12.1-7.	Reference Case #3a – IP-to-TDM Call Over an IP Backbone.....	12-8
Table 12.1-8.	Reference Case #3b – IP-to-TDM Call Translated at Destination Enclave.....	12-9
Table 12.6-1.	26/Q.1912.....	12-18
Table 12.6-2.	37/Q.1912.5.....	12-23
Table 12.6-3.	40/Q.1912.5.....	12-25
Table 12.7-1.	6/Q.1912.5.....	12-32
Table 12.7-2.	21/Q.1912.5.....	12-39
Table 12.7-3.	22/Q.1912.5.....	12-43
Table 14.7-1.	SIP tgrp to ISDN Q.931 Mapping.....	14-8
Table 15.2-1.	Table of Correspondence Between MLPP Bits in ISUP Message and Character Representation of Single Decimal Value for “r-priority” Field in Resource-Priority Header	15-2

SECTION 1 INTRODUCTION

1.1 PURPOSE

This document defines the technical specifications for the Unified Capabilities (UC) Requirements (UCR) signaling protocol. Assured Services (AS) Session Initiation Protocol (SIP) (AS-SIP) is the standard signaling protocol used within the Department of Defense (DoD) information systems networks that provide End-to-End Assured Services. This specification is based on the commercial standards for the SIP (e.g., Request for Comments [RFC] 3261 and others as listed in UC Framework 2013 Appendix C). Assured Services capabilities are provided by adding specific elements to the SIP protocol.

1.2 SCOPE

This document defines signaling requirements for operation within an Internet protocol (IP)-only network infrastructure and for inter-working between IP network segments and legacy Time-Division Multiplexing (TDM) network segments in a hybrid IP and TDM network infrastructure. [Sections 1](#) through [13](#) of this specification address the enabling of signaling for Assured Service over the IP-only network infrastructure. [Sections 12](#) through [16](#) of this specification address Assured Services operation across a hybrid network infrastructure. More specifically, [Sections 12.1](#) through [16.6](#) define the TDM-IP signaling interoperability requirements placed on Session Controllers (SCs), Softswitches (SSs) and Media Gateways (MGs) to support calls that traverse both the TDM and IP network segments. The hybrid interoperability requirements are described in terms of TDM-to-IP call flows and IP-to-TDM call flows.

1.2.1 SBU and Classified Requirements

This document defines common AS-SIP signaling requirements applicable to both the Sensitive but Unclassified (SBU) network and the classified network. However, a subset of AS-SIP signaling requirements applies exclusively to the classified network. The requirement numbers for the subset of classified-only requirements is listed in the following text for the reader's convenience:

- Requirements SIP-0001060 through SIP-001080 (SC Route Header Requirements).
- Requirements SIP-001090 through SIP-001120 (Tier0 SS Route Header Requirements).
- Requirement SIP-001340 (Proxy Require header).
- Requirements SIP-001560 and SIP-001570 - SIP-001600 (418 response).
- Requirements SIP-002250 through SIP-002380 (SIP Preconditions).
- [Section 4.9](#) (Confidentiality Access Level General Requirements).
- Requirements SIP-004450 through SIP-004470 (Precedence Levels).

In addition, the subsections of [Section 6](#), Precedence and Preemption, that specify “domain name,” “namespace,” and/or “domain” subfields define the “uc” network-domain as Required for the SBU environment, and the “cuc” network-domain as Required for the classified environment.

1.3 APPLICABILITY

This specification applies to signaling products used within DoD Assured Services networks, and represents functional requirements to enable interoperability among various signaling products. It is not the intent of this generic requirements specification to be a complete product specification for signaling appliances. As a generic requirements specification, the capability to provide AS-SIP signaling by a product [e.g., Session Controllers (SCs), Softswitch (SS)] is called out by the respective product specifications in UCR 2013 Section 2, Session Control Products. It is expected that the product specifications are the basis for certification testing and for the product being placed on the DoD UC Approved Products List (APL).

1.4 UCR 2013 DOCUMENT SUITE

This specification is one of several DoD documents that specify requirements for Assured Services networks and requirements for products to achieve DoD UC Approved Products List (APL) certification. The UC requirements documents that are included in the UCR scope are shown in [Figure 1.4-1](#)., and included the following:

- UCR 2013 – specifies the functional requirements, performance objectives and technical specifications.
- AS-SIP 2013 – contains the requirements for the IP-based UC Signaling system.
- UC XMPP 2013 – contains the requirements for multivendor interoperability as required to exploit the full potential of Instant Messaging (IM), Chat, and Presence across DoD.
- UC Framework 2013 – specifies the descriptive text and design associated with each of the UCR 2013 sections.

The reference documents used are cited in UC Framework 2013, Appendix C, Definitions, Abbreviations and Acronyms, and References.



Figure 1.4-1. UC 2013 Document Suite

1.5 APPLICABLE STANDARDS

The standards used in this section are provided in DoD UC Framework 2013, Appendix C, Definitions, Abbreviations and Acronyms, and References, and are referenced as part of the AS-SIP specification.

1.6 SPECIFICATION LANGUAGE AND SYNTAX

The AS-SIP requirement contained in this document is built on Internet Engineering Task Force (IETF) RFCs. The AS-SIP requirement therefore adheres to the IETF terminology which use terms or key words including “MUST,” “MUST NOT,” “REQUIRED,” “SHALL,” “SHALL NOT,” “SHOULD,” “SHOULD NOT,” “RECOMMENDED,” “NOT RECOMMENDED,” “MAY,” and “OPTIONAL.” These terms are to be interpreted as described in IETF Basic Call Processing (BCP) 14, RFC 2119 and indicate requirement levels for compliant SIP implementations.

1.7 GENERAL REQUIREMENT LANGUAGE

The word “REQUIRED” or the term “MUST” or “SHALL” means the definition is an absolute requirement of the product.

The word “OPTIONAL” or the term “MAY” means an item is optional.

The word “CONDITIONAL” means a requirement is dependent on a condition. The text of a CONDITIONAL requirement may use the “If <CONDITIONAL>, then <requirement>” format. An example of a CONDITIONAL requirement is “If the system provides authentication via the SIP digest method, then the SIP digest implementation shall be in accordance with RFC 3621.

The phrase “MUST NOT” or “SHALL NOT” means the definition is an absolute prohibition of the item.

The word “RECOMMENDED” means the reference is given as guidance and is not a testable requirement.

1.7.1 Product Applicability

This document identifies the minimum functional and performance requirements for products to be placed on the UC APL. Requirements are specified in terms of two categories: Minimum requirements and Conditional requirements.

1.7.1.1 Minimum Requirements

Minimum requirements are features and capabilities considered necessary for a particular product to support warfighter missions in the DoD. These features and capabilities will require certification before introduction into the Defense Information Systems Network (DISN).

1.7.1.2 Optional Requirements

Optional requirements are features and capabilities that are not considered critical for DoD mission support based on DoD policies. Nevertheless, it is recognized that such features do have utility for some users or for specific operations. To ensure interoperability and consistency of the Assured Services (AS) across all platforms, these features and capabilities are specified with set parameters. If these features and capabilities are provided, the UC product shall perform and meet the requirements as identified in the UCR.

1.8 DEFINITIONS

Definitions are found in UCR 2013, Appendix C, Definitions, Abbreviations and Acronyms, and References.

SECTION 2 SIGNALING DESIGN

The network-level signaling design is depicted in [Figure 2-1](#), Network-Level AS-SIP Signaling Design. The signaling architecture is constructed as a two-tier hierarchy. Local Session Controllers are located at B/P/C/Ss and represent the level of the signaling hierarchy closest to the End Instrument (EI), and they may be thought of as the packet-switched equivalent of the End Office (EO), PBX1, or PBX2. Softswitches are located at SDNs and represent the upper level of the hierarchy, and they may be thought of as analogous to Class 4 Tandem Switches. Functionally, SSs are composed of a Tier 0 Session Controller (SC) and an interworking function (IWF) enabling interoperability in the signaling plane between the IP portion of the Defense Switched Network (DSN) and the TDM portion of the DSN. An associated Media Gateway (MG) function performs the interworking between TDM circuit-switched bearer streams and Real-Time Transport Protocol (RTP)/User Datagram Protocol (UDP)/IP packets.

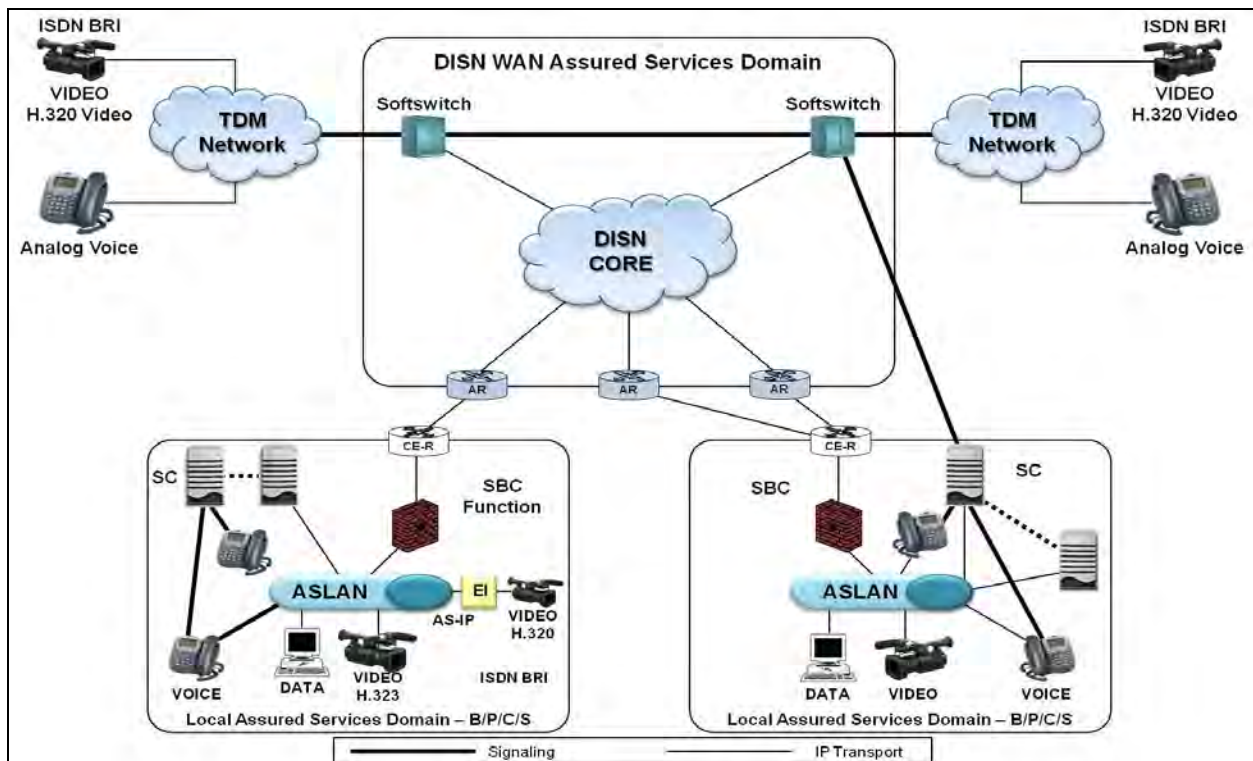

Figure 2-1. Network-Level AS-SIP Signaling Design

Every SC is assigned to a primary softswitch (SS) and to at least one secondary SS.

Every SS serves a set of SCs that may be located at various B/P/C/Ss.

All voice and video call signaling messages received by an SC from local EIs and intended for a destination over the UC Wide Area Network (WAN) are sent by the SC in the form of an AS-SIP message to the assigned SS. Similarly, all voice and video call signaling messages sent from a remote location and intended for IP EIs associated with a given SC will be routed to the SS

assigned to the destination SC and the SS will forward the AS-SIP signaling messages to the destination SC.

The basic AS-SIP message flow between an originating SC assigned to one SS and a destination SC assigned to another SS is:

Originating SC --- SS 1 ----- SS 2 --- Destination SC

The basic AS-SIP message flow between an originating SC and a destination SC assigned to the same SS is:

Originating SC --- SS --- Destination SC

The access link between the Customer Edge (CE) Router (CE-R) and the Aggregation Router (AR) is resource constrained and the SC has primary responsibility for ensuring that the telephony traffic across the access link does not exceed a provisioned threshold call count and that the video traffic across the access link does not exceed a provisioned threshold bandwidth.

The SS is responsible for implementing a Policing function to protect the access links (and to protect the DSN itself) whereby the SS intervenes by blocking call requests or preempting call requests and existing calls when the SS determines that the SC has exceeded its provisioned threshold for voice or video traffic.

The UC WAN is considered to be bandwidth-unlimited.

SECTION 3 CALLING PATH REFERENCE CASES

Based on the design described in [Section 2](#), Signaling Design, the calling patterns that must be supported to provide the telephony services can be identified. This section lists the referenced calling paths for the signaling associated with IP-to-IP calls over an IP core (see [Figure 3-1](#), IP-to-IP Calls over an IP Backbone).

The calling path reference cases for calls involving both IP and TDM signaling appliances may be found in [Section 12](#), SIP Translation Requirements for Interworking AS-SIP Signaling Appliances.

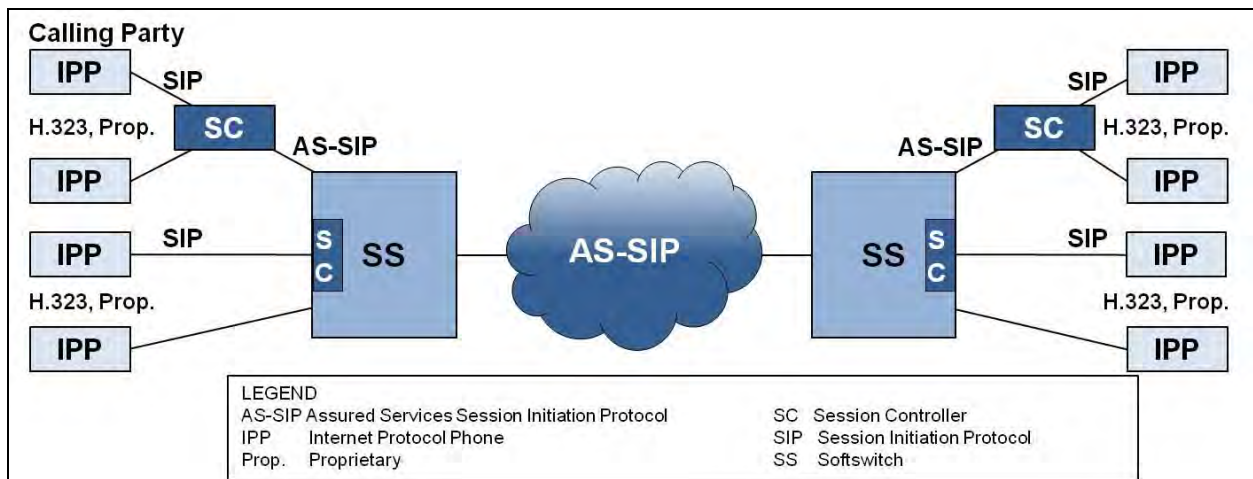

Figure 3-1. IP-to-IP Calls Over an IP Backbone

NOTE: Reference Cases 2A through 2P (see [Table 3-1](#), Reference Case: IP-to-IP Calls over an IP Backbone) represent the call paths when the same SS serves both the calling party and called party's SC (or the calling party's EI directly) and the called party's SC (or the called party's EI directly).

Table 3-1. Reference Case: IP-to-IP Calls Over an IP Backbone

REF. CASE	ORIGINATOR PHONE	ORIGINATOR SIGNALING	NETWORK SIGNALING AND CALL PATH							TERMINATOR SIGNALING	TERMINATOR PHONE
			SC	AS-SIP	SS	AS-SIP	SS	AS-SIP	SC		
1A	IP phone	AS-SIP	SC	AS-SIP	SS	AS-SIP	SS	AS-SIP	SC	AS-SIP	IP phone
1B	IP phone	AS-SIP	SC	AS-SIP	SS	AS-SIP	SS	AS-SIP	SC	H323, Prop, SIP	IP phone
1C	IP phone	AS-SIP	SC	AS-SIP	SS	AS-SIP	←SS SC comp →			AS-SIP	IP phone
1D	IP phone	AS-SIP	SC	AS-SIP	SS	AS-SIP	←SS SC comp →			H323, Prop, SIP	IP phone
1E	IP phone	H323, Prop, SIP	SC	AS-SIP	SS	AS-SIP	SS	AS-SIP	SC	AS-SIP	IP phone
1F	IP phone	H323, Prop, SIP	SC	AS-SIP	SS	AS-SIP	SS	AS-SIP	SC	H323, Prop, SIP	IP phone
1G	IP phone	H323, Prop, SIP	SC	AS-SIP	SS	AS-SIP	←SS SC comp →			AS-SIP	IP phone
1H	IP phone	H323, Prop, SIP	SC	AS-SIP	SS	AS-SIP	←SS SC comp →			H323, Prop, SIP	IP phone
1I	IP phone	AS-SIP			← SC comp SS →	AS-SIP	SS	AS-SIP	SC	AS-SIP	IP phone
1J	IP phone	AS-SIP			← SC comp SS →	AS-SIP	SS	AS-SIP	SC	H323, Prop, SIP	IP phone
1K	IP phone	AS-SIP			← SC comp SS →	AS-SIP	←SS SC comp →			AS-SIP	IP phone
1L	IP phone	AS-SIP			← SC comp SS →	AS-SIP	←SS SC comp →			H323, Prop, SIP	IP phone
1M	IP phone	H323, Prop, SIP			← SC comp SS →	AS-SIP	SS	AS-SIP	SC	AS-SIP	IP phone
1N	IP phone	H323, Prop, SIP			← SC comp SS →	AS-SIP	SS	AS-SIP	SC	H323, Prop, SIP	IP phone
1O	IP phone	H323, Prop, SIP			← SC comp SS →	AS-SIP	←SS SC comp →			AS-SIP	IP phone
1P	IP phone	H323, Prop, SIP			← SC comp SS →	AS-SIP	←SS SC comp →			H323, Prop, SIP	IP phone

REF. CASE	ORIGINATOR PHONE	ORIGINATOR SIGNALING	NETWORK SIGNALING AND CALL PATH							TERMINATOR SIGNALING	TERMINATOR PHONE
2A	IP phone	AS-SIP	SC	AS-SIP	SS	AS-SIP			SC	AS-SIP	IP phone
2B	IP phone	AS-SIP	SC	AS-SIP	SS	AS-SIP			SC	H323, Prop, SIP	IP phone
2C	IP phone	AS-SIP	SC	AS-SIP	← SS SC comp →					AS-SIP	IP phone
2D	IP phone	AS-SIP	SC	AS-SIP	← SS SC comp →					H323, Prop, SIP	IP phone
2E	IP phone	H323, Prop, SIP	SC	AS-SIP	SS	AS-SIP			SC	AS-SIP	IP phone
2F	IP phone	H323, Prop, SIP	SC	AS-SIP	SS	AS-SIP			SC	H323, Prop, SIP	IP phone
2G	IP phone	H323, Prop, SIP	SC	AS-SIP	← SS SC comp →					AS-SIP	IP phone
2H	IP phone	H323, Prop, SIP	SC	AS-SIP	← SS SC comp →					H323, Prop, SIP	IP phone
2I	IP phone	AS-SIP			← SC comp SS →	AS-SIP			SC	AS-SIP	IP phone
2J	IP phone	AS-SIP			← SC comp SS →	AS-SIP			SC	H323, Prop, SIP	IP phone
2K	IP phone	AS-SIP			← SC comp SS SC comp →					AS-SIP	IP phone
2L	IP phone	AS-SIP			← SC comp SS SC comp →					H323, Prop, SIP	IP phone
2M	IP phone	H323, Prop., SIP			← SC comp SS →	AS-SIP			SC	AS-SIP	IP phone
2N	IP phone	H323, Prop, SIP			← SC comp SS →	AS-SIP			SC	H323, Prop, SIP	IP phone
2O	IP phone	H323, Prop, SIP			← SC comp SS SC comp →					AS-SIP	IP phone

REF. CASE	ORIGINATOR PHONE	ORIGINATOR SIGNALING	NETWORK SIGNALING AND CALL PATH						TERMINATOR SIGNALING	TERMINATOR PHONE	
2P	IP phone	H323, Prop, SIP			← SC comp SS SC comp →					H323, Prop, SIP	IP phone
NOTE: ¹ SC comp = the SC component of the SS											

SECTION 4 SIP REQUIREMENTS FOR AS-SIP SIGNALING APPLIANCES AND AS-SIP EIS

4.1 INTRODUCTION

In this document, the term AS-SIP signaling appliance refers to SCs and SSs.

NOTE: The term AS-SIP signaling appliances as used in this document intentionally does not encompass Session Border Controllers (SBCs) as they are not a primary subject of the requirements of this document. However, it should be noted that SBCs are signaling platforms that process AS-SIP messages and that a small number of requirements herein apply to SBCs. In those instances the requirements will affirmatively indicate applicability to SBCs.

The SC or the SC component of an SS is the signaling plane appliance that directly serves an IP EI. ~~The SC serves two main categories of IP EIs as follows:~~

~~For signaling purposes IP EIs are divided into three basic categories¹:~~

- ~~AS-SIP EIs with Precedence & Preemption (P&P): EIs that support the AS-SIP signaling protocol as defined herein including the Resource-Priority header, session priority, precedence rules and endpoint preemption.~~
- ~~Routine-Only (RO) AS-SIP EIs: EIs that support the AS-SIP signaling protocol as defined herein with the exception that the EI does not support generating or processing the Resource-Priority header², is unaware of call priority, does not initiate precedence calls, upon receiving call requests does not differentiate between routine calls and the various levels of precedence calls, and does not support endpoint preemption.~~
- ~~AS-SIP EIs are IP EIs that support the AS-SIP signaling protocol as defined herein.~~
- Proprietary IP EIs: (i.e., SIP EIs, H.323 EIs, other vendor-proprietary EIs) where, in some instances, a further distinction with respect to SC requirements is made between SIP EIs and H.323 or vendor proprietary EIs.

~~NOTE: The term AS-SIP EI is used in the AS-SIP specification when the requirement in question applies to both AS-SIP EIs with P&P and to RO AS-SIP EIs.~~

~~It should be noted that the category to which an IP EI belongs determines the signaling requirements applicable to that IP EI. In addition, the SC signaling requirements and~~

¹ 02 UCR 2013 sec 2.9 provides a more granular description of IP EI categories that takes into account additional characteristics that transcend signaling.

² When the RO AS-SIP EI receives a Resource-Priority header in an AS-SIP message the RO AS-SIP EI ignores the Resource-Priority header and continues processing the message.

responsibilities (as detailed in this specification) vary depending upon the category of IP EI that is being served by the SC.

~~This specification provides differentiated sets of requirements for proprietary EIs that are SIP EIs and that are H.323 and vendor proprietary EIs.~~

~~The SCs that support SIP EIs MUST comply with the differentiated set of requirements defined for SIP EIs if they serve SIP EIs, and SCs MUST comply with the differentiated set of requirements defined for H.323 and/or vendor proprietary EIs if they serve H.323 and/or vendor proprietary EIs.~~

4.1.1 SCs Serving AS-SIP EIs

SIP-000005 [Optional: SC] SC support for the interoperable AS-SIP line side interface and the capability to serve AS-SIP EIs is an optional requirement.

SIP-000010 When an AS-SIP EI is served by (i.e., assigned to) an SC the assigned SC MUST be the recipient of every outbound AS-SIP message sent by the AS-SIP EI.

SIP-000020 The SC to which the AS-SIP EI is assigned MUST be the recipient of every inbound AS-SIP message intended for the AS-SIP EI.

SIP-000030 [Optional] The SC serving the AS-SIP EI MUST support authentication of the AS-SIP EIs.

SIP-000030.a The SC MAY require the user of an AS-SIP EI to perform user authentication to the SC when the user initiates a precedence call request (RFC 3261, Sections 22.1, Framework; 22.3, Proxy-to-User Authentication; and 22.4, The Digest Authentication Scheme).

SIP-000040 An SC serving an AS-SIP EI MAY be capable of operating as a redirect server (RFC 3261, Section 8.3, Redirect Servers.)

SIP-000050 If the SC serving an AS-SIP EI receives a SIP message with an encapsulated Integrated Services Digital Network User Part (ISUP) message (i.e., application/ISUP multi-purpose Internet mail extension [MIME] object), then the SC MUST do one of the following:

- Respond with a 405 (Method Not Allowed) response.
- Respond with a 415 (Unsupported Media Type) response with an Accept header that includes the supported Content-Types but does not include application/isup.

SIP-000055 When an SC forwards a precedence INVITE to a served AS-SIP EI and receives either a 486 response or a 480 response from the AS-SIP EI then the SC MUST ACK the 480 or 486 response and divert the precedence INVITE to the attendant.

SIP-000056 [Optional: SC] It is an optional requirement for the SC to keep track of the EI category to which each of its served AS-SIP EIs belongs (i.e. the SC is not required to know whether a given served AS-SIP EI is an AS-SIP EI with P&P or a RO AS-SIP EI).

SIP-000057 When a SC receives an initial INVITE or a REFER from a served AS-SIP EI and the initial INVITE or REFER does not include a Resource-Priority header field, then:

- If the precedence digit represents a ‘routine’ priority the SC MUST add a Resource-Priority header field (see SIP-004474).
- If the precedence digit represents a priority above ‘routine’ (precedence call) and the SC does not keep track of the EI category to which each of its served AS-SIP EIs belongs then the SC adds a Resource-Priority header field and MAY authenticate the requester and determine the requester’s authorization to make a call at the selected precedence (see SIP-004474).
- If the precedence digit represents a priority above ‘routine’ (precedence call) and the SC keeps track of the EI category to which each AS-SIP EI belongs and the AS-SIP EI that generated the initial INVITE is an AS-SIP EI with P&P then the SC adds a Resource-Priority header field and MAY authenticate the requester and determine the requester’s authorization to make a call at the selected precedence (see SIP-004474).
- If the precedence digit represents a priority above ‘routine’ (precedence call) and the SC keeps track of the EI category to which each AS-SIP EI belongs and the AS-SIP EI that generated the initial INVITE is a RO AS-SIP EI then the SC plays the Unauthorized Precedence Announcement and sends a 403 Forbiddent response to terminate the call (see SIP-004478).

SIP-000058 When a SC receives a re-INVITE or UPDATE from a served AS-SIP EI that does not include a Resource-Priority header field, the SC MUST add a Resource-Priority header.

4.1.2 SCs Serving IP EIs Other Than AS-SIP EIs

SIP-000060 When an IP EI (other than an AS-SIP EI) is served by (i.e., assigned to) an SC, then the SC MUST be the recipient of every outbound call signaling message sent by the IP EI.

NOTE: In the case of a SIP EI, the SC is responsible for performing the translation function between the SIP signaling on the line side to the AS-SIP signaling on the trunk side.

NOTE: In the case of H.323 or other vendor-proprietary signaling, the SC is responsible for performing the translation function between the H.323 or vendor-proprietary signaling on the line side to the AS-SIP signaling on the trunk side.

SIP-000070 When an IP EI (other than an AS-SIP EI) is served by (i.e., assigned to) an SC, then the SC MUST be the recipient of every inbound AS-SIP message intended for the IP EI.

NOTE: In the case of a SIP EI, the SC is responsible for performing the translation function between the AS-SIP signaling on the trunk side to the SIP signaling on the line side.

NOTE: In the case of H.323 or other vendor-proprietary signaling, the SC is responsible for performing the translation function between the AS-SIP signaling on the trunk side and the H.323 or vendor-proprietary signaling on the line side.

SIP-000080 [Optional] The SCs serving IP EIs (other than AS-SIP EIs) **MUST** support authentication of the IP EIs. The user of the IP EI is required to perform user authentication to the SC when initiating precedence call requests.

SIP-000080.a The SC **MAY** require the user of an IP EI to perform user authentication to the SC when the user initiates a precedence call request.

SIP-000090 The SCs serving IP EIs **MAY** be capable of operating as redirect servers (RFC 3261, Section 8.3, Redirect Servers).

SIP-000100 The SCs serving H.323 and/or proprietary IP EIs **MUST** comply with the rules for user agent client (UAC) behavior outside of a dialog (RFC 3261, Section 8.1, UAC Behavior, and subsections).

SIP-000110 The SCs serving H.323 and/or proprietary IP EIs **MUST** comply with the rules for user agent server (UAS) behavior outside of a dialog (RFC 3261, Section 8.2, UAS Behavior, and subsections).

SIP-000120 When an SC serving H.323 and/or proprietary EIs receives a request that contains a Require header field with one or more option tags that it does not understand, then it **MUST** return a 420 (Bad Extension) response code. The response **MUST** include an Unsupported header field listing those option tags the element did not understand (RFC 3261, Section 8.2.2.3, Require).

SIP-000130 The SCs serving H.323 and/or proprietary EIs **MUST** comply with the rules and procedures for dialogs (RFC 3261, Section 12, Dialogs).

SIP-000140 If the SC serving IP EIs (other than AS-SIP EIs) receives a SIP message with an encapsulated ISUP message (i.e., application/isup MIME object), then the SC **MUST** do one of the following:

- Respond with a 405 (Method Not Allowed) response.
- Respond with a 415 (Unsupported Media Type) response with an Accept header that includes the supported Content-Types but does not include application/isup.

4.1.3 Basic Requirements

SIP-000150 All AS-SIP signaling appliances **MUST** be call stateful.

SIP-000160 All AS-SIP signaling appliances **MUST** comply with the SIP syntax and encoding rules set forth in RFC 3261 ([see RFC 3261, Section 25, Augmented BNF for the SIP Protocol] and with the corrections in RFC 5954 Essential Correction for IPv6 Augmented Backus-Naur Form [BNF] [ABNF] and Uniform Resource Indicator [URI] Comparison in RFC 3261).

SIP-000170 All AS-SIP EIs **MUST** comply with the SIP syntax and encoding rules set forth in RFC 3261 (See RFC 3261, Section 25, Augmented BNF for the SIP Protocol, and with the corrections in RFC 5954 Essential Correction for IPv6 ABNF and URI Comparison in RFC 3261).

SIP-000180 All AS-SIP signaling appliances **MUST** comply with the requirement for SIP message structure set forth in RFC 3261, which covers SIP requests, SIP responses, SIP header fields, and SIP bodies (RFC 3261, Section 7, SIP Messages).

SIP-000190 All AS-SIP EIs **MUST** comply with the requirement for SIP message structure set forth in RFC 3261, which covers SIP requests, SIP responses, SIP header fields, and SIP bodies (RFC 3261, Section 7, SIP Messages).

SIP-000200 When an AS-SIP signaling appliance does not understand a header field in a request (and support for the header field is not a mandatory requirement under this specification), the AS-SIP signaling appliance **MUST** ignore that header field and continue processing the message. The AS-SIP signaling appliances **MUST** ignore any malformed header fields that are not necessary for processing requests (RFC 3261, Section 8.2.2, Header Inspection).

SIP-000210 When an AS-SIP EI does not understand a header field in a request (and support for the header field is not a mandatory requirement under this specification), the AS-SIP EI **MUST** ignore that header field and continue processing the message. The AS-SIP EIs **MUST** ignore any malformed header fields that are not necessary for processing requests (RFC 3261, Section 8.2.2, Header Inspection).

SIP-000220 The AS-SIP signaling appliances that function as B2BUAs **MUST** preserve header fields they do not understand when copying SIP messages from one side of the B2BUA to the other.

NOTE: A B2BUA is a logical entity that receives a request and processes it as a UAS. To determine how the request should be answered, it acts as a UAC and generates requests. Unlike a proxy server, it maintains dialog state and must participate in all requests sent on the dialogs it has established. Since it is a concatenation of a UAC and UAS, no explicit definitions are needed for its behavior (RFC 3261).

SIP-000230 When an AS-SIP signaling appliance that is implemented as a SIP proxy, receives a SIP Request message, 2xx response, or 18x response, then the AS-SIP signaling appliance **MUST** add a Record-Route header whereby the userinfo part of the SIP URI is a unique identifier for the AS-SIP signaling appliance and an IP address is used for the host name.

Example:

Record-Route: <sip:SC3@192.168.24.132;lr>

NOTE: This requirement is not applicable to an AS-SIP signaling appliance that is implemented as a B2BUA.

SIP-000240 When an SC, SS, or Session Border Controller (SBC) is implemented as a B2BUA, then the following occurs:

- Whenever the SC, SS, or SBC receives a SIP request, before it forwards the request downstream, the SC, SS, or SBC **MUST** replace the hostname part of the SIP URI of the Contact header with its own routable IP address (i.e., B2BUAs perform this replacement on all SIP requests).
- Whenever the SC, SS, or SBC receives a SIP response, before it forwards the response upstream, the SC, SS, or SBC **MUST** replace the hostname part of the SIP URI of the Contact header with its own routable IP address (i.e., B2BUAs perform this replacement on all SIP responses).

SIP-000250 Upon receipt of a new request, AS-SIP signaling appliances **MUST** perform request validation, route information preprocessing, determine request targets, perform request forwarding, perform response processing, process timer C, handle transport error, handle CANCEL processing, and perform proxy route processing according to RFC 3261 (RFC 3261, Sections 16.3, Request Validation; 16.4, Route Information Preprocessing; 16.5, Determine Request Targets; 16.6, Perform Request Forwarding; 16.7, Perform Response Processing; 16.8, Process Timer C; 16.9, Handle Transport Error; 16.10, Handle CANCEL Processing; and 16.12, Perform Proxy Route Processing, respectively).

NOTE: Nothing in this requirement is to be interpreted to preclude an AS-SIP signaling appliance from being implemented by a B2BUA. In that case, the functions above that apply to a B2BUA **MUST** be implemented and the functions associated solely with a proxy server but not with a B2BUA (e.g., proxy route and timer C processing) are not required as long as the functional requirements and interoperability requirements of the AS-SIP signaling appliance, as defined in this specification, are met.

SIP-000260 All AS-SIP signaling appliances **MUST** comply with the requirements applicable to non-INVITE client transactions (RFC 3261, Sections 17.1.2, Non-INVITE Client Transaction; 17.1.3, Matching Responses to Client Transactions; 17.1.4, Handling Transport Errors; 17.2.2, Non-INVITE Server Transaction; 17.2.3, Matching Requests to Server Transactions; and 17.2.4, Handling Transport Errors).

SIP-000270 All AS-SIP EIs **MUST** comply with the requirements applicable to non-INVITE client transactions (RFC 3261, Sections 17.1.2, Non-INVITE Client Transaction; 17.1.3, Matching Responses to Client Transactions; 17.1.4, Handling Transport Errors; 17.2.2, Non-INVITE Server Transaction; 17.2.3, Matching Requests to Server Transactions; and 17.2.4, Handling Transport Errors).

SIP-000280 All AS-SIP signaling appliances MUST support generation of the long form of the SIP header fields along with the receipt and processing of the long form of the SIP header fields.

NOTE: The long form is the default for the SIP header fields.

SIP-000290 All AS-SIP EIs MUST support generation of the long form of the SIP header fields along with the receipt and processing of the long form of the SIP header fields.

NOTE: The long form is the default for the SIP header fields.

SIP-000300 All AS-SIP signaling appliances MUST support receiving and processing the compact form of the SIP header fields (RFC 3261, Section 20, Header Fields).

SIP-000310 All AS-SIP EIs MUST support receiving and processing the compact form of the SIP header fields (RFC 3261, Section 20, Header Fields).

SIP-000320 All AS-SIP signaling appliances serving IP EIs MUST support the offer/answer model for the Session Description Protocol (SDP) (RFC 3264).

SIP-000330 All AS-SIP EIs MUST support the offer/answer model for the SDP (RFC 3264).

SIP-000340 An IP packet is allowed only to carry one AS-SIP request message or AS-SIP response message. In other words, multiple AS-SIP messages are not permitted to be carried as the payload of any given IP packet.

4.1.4 Failure To Establish TLS Connection

SIP-000350 If an SC receives a call request from a served IP EI and the SC has been unable to establish a Transport Layer Security (TLS) connection with its SBC and is unable to do so upon receipt of the INVITE, then the SC MUST ensure that the IP EI plays the Isolated Code Announcement (ICA) and terminates the call request and MUST send an alarm to the Network Management System (NMS). The alarm MUST notify the NMS that the SC was unable to establish a TLS connection and MUST provide the identity of the SBC with which the SC was unable to establish the TLS connection.

SIP-000360 If an SC receives an INVITE from a served AS-SIP EI and the SC has been unable to establish a TLS connection with its SBC and is unable to do so upon receipt of the INVITE, then the following occurs:

SIP-000360.a The SC MUST notify the NMS that the SC was unable to establish a TLS connection and MUST provide the identity of the SBC with which the SC was unable to establish the TLS connection.

SIP-000360.b The SC MUST establish a bearer connection between the AS-SIP EI and a media server associated with the SC. See [Figure 4.1-1](#), SC Implements Playing of ICA at AS-SIP EI. The SC and media server exchange the necessary signaling to provide the media server with the IP address and UDP port for the bearer stream with the AS-SIP EI

and the SC instructs the media server to play the ICA over the bearer stream to the AS-SIP EI after the bearer is established. The 183 (Session Progress) response sent by the SC to the AS-SIP EI includes the sdp answer with the IP address and UDP port for a bearer stream with the media server. The AS-SIP EI responds with a Provisional Response Acknowledgement (PRACK) to which the SC responds with a 200 (OK) response. The media server plays the announcement to the AS-SIP EI and terminates the session with the SC, and the SC sends a 408 (Request Timeout) response to the AS-SIP EI. The AS-SIP EI responds with an Acknowledgement (ACK) and terminates the call request.

NOTE: The media server is considered a part of the SC SUT; therefore, the signaling between the SC and media server is left to the vendor as long as the announcement is played and the signaling between the SC and AS-SIP EI complies with the specific call flow depicted in this section.

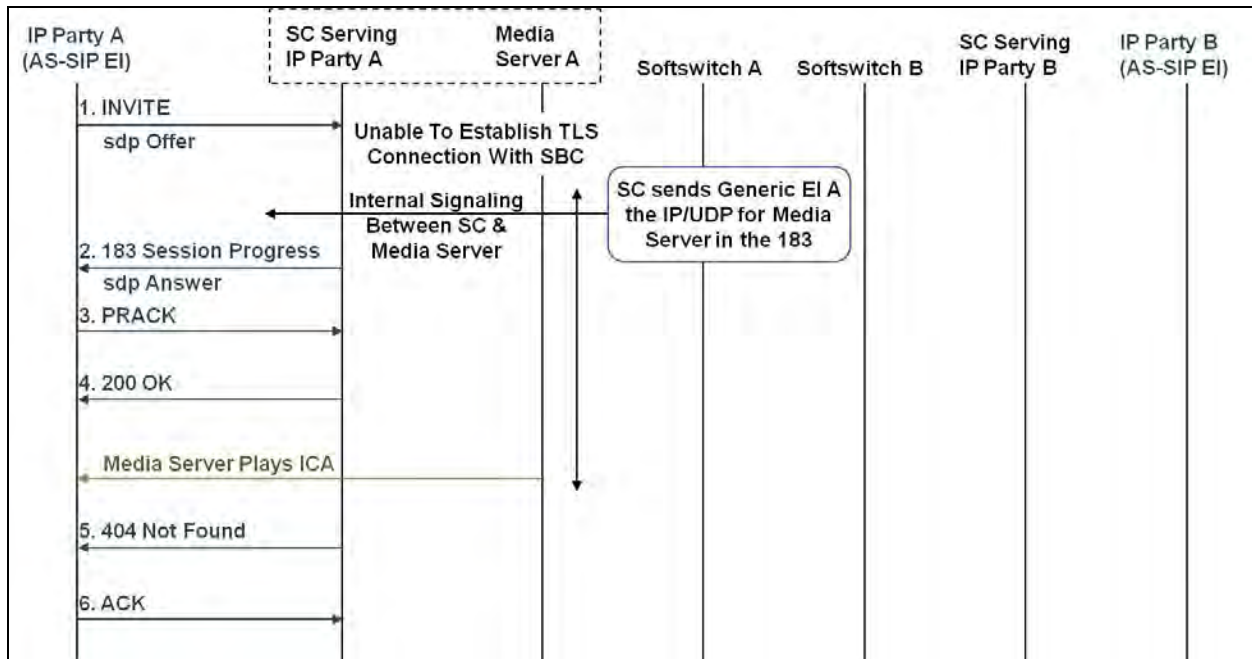

Figure 4.1-1. SC Implements Playing of ICA at AS-SIP EI

SIP-000370 If an SBC receives an INVITE from its AS-SIP signaling appliance and has been unable to establish a TLS connection with either the SBC or the AS-SIP signaling appliance that is the next hop for the INVITE and is unable to do so upon receipt of the INVITE, then the SBC MUST reply to the INVITE with a 408 (Request Timeout) response with a Warning header with warn-code 399 (Miscellaneous warning) and warn-text “TLS connection failure.”

NOTE: At the Network Element (NE) level, an alarm MUST be sent to the NMS when an AS-SIP signaling appliance is unable to establish a Transmission Control Protocol (TCP)/TLS connection with another AS-SIP signaling appliance or whenever a TCP/TLS connection terminates abnormally.

SIP-000380 [**Conditional: SS, SC, MG, SBC, AEI**] If the system uses TLS to transport AS-SIP messages, the system shall support the use of the keep alive mechanism described in RFC 5626 to avoid closure of the TLS given session due to inactivity. This capability shall be configurable.

NOTE: Because this requirement is configurable, implementations are still permitted to drop an AS-SIP supporting TLS session during periods of inactivity to conserve system resources. However, when using this approach, care must be taken in environments that have firewalls which might prevent session re-establishment. Also, post-dial delay must be minimized when dropping and re-establishing TLS sessions.

SIP-000380.a [**Conditional: SS, SC, MG, SBC, AEI**] If the system utilizes TLS to transport AS-SIP messages, the system shall support the transmission of the four character “carriage return-line feed-carriage return-line feed” sequence, described in RFC 5626, Section 4.4.1, based on a configurable inactivity timer.

NOTE: This inactivity timer would reset every time a new AS-SIP message is transmitted. The maximum value of this timer would be preconfigured.

SIP-000380.b [**Conditional: SS, SC, MG, SBC, AEI**] If the system uses TLS to transport AS-SIP messages, the system shall support the capability to respond to a received "carriage return-line feed-carriage return-line feed" sequence by sending the two character "carriage return-line feed" sequence, in accordance with (IAW) RFC 5626 Section 4.4.1.

4.1.5 Vacant Code Treatment

SIP-000390 When an SS receives an INVITE from either a served SC or another SS where the Request-URI has a DSN telephone number for which the SS has no entry in its location server, then the SS MUST respond with a 404 (Not Found) response. Upon receipt of the 404 (Not Found) response message, the originating SC sends an ACK to its SS (SS A in [Figure 4.1-2](#)) and is responsible for ensuring that the following occurs:

SIP-000390.a The EI plays the Vacant Code Announcement (VCA): “Remote signaling switch. Your call cannot be completed as dialed. Please consult your directory and call again or ask your operator for assistance. This is a recording. Remote signaling switch.”

SIP-000390.b The EI is instructed to terminate the call. In the case of a SIP EI, the originating SC forwards the 404 (Not Found) response after the VCA is played to the user.

SIP-000390.c In the case of an AS-SIP EI, the SC establishes a bearer connection between the AS-SIP EI and a media server associated with the SC (See [Figure 4.1-2](#), SC Implements Playing of VCA at AS-SIP EI). The SC and media server exchange the necessary signaling to provide the media server with the IP address and UDP port for the

bearer stream with the AS-SIP EI and the SC instructs the media server to play the VCA over the bearer stream to the AS-SIP EI after the bearer is established. The 183 (Session Progress) response sent by the SC to the AS-SIP EI includes the sdp answer with the IP address and UDP port for a bearer stream with the media server. The AS-SIP EI responds with a PRACK to which the SC responds with a 200 (OK) response. The media server plays the announcement to the AS-SIP EI and terminates the session with the SC, and the SC sends a 404 (Not Found) response to the AS-SIP EI. The AS-SIP EI responds with an ACK and terminates the call request.

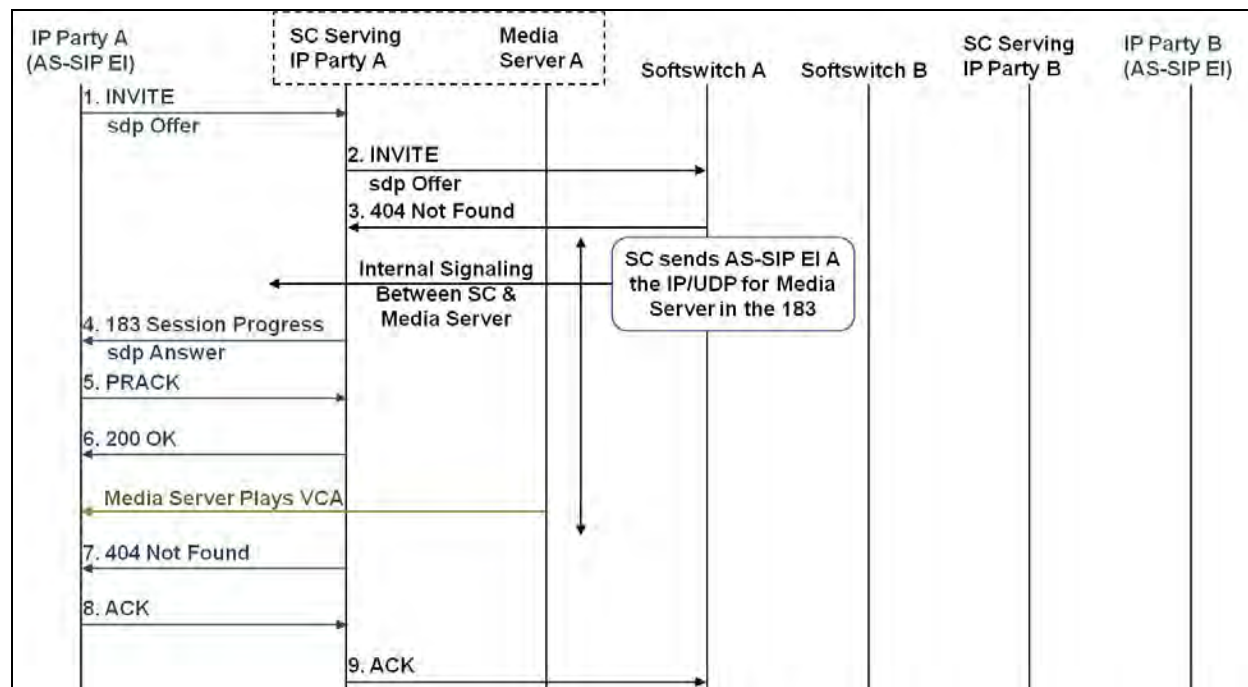

Figure 4.1-2. SC Implements Playing of VCA at AS-SIP EI

NOTE: The media server is considered a part of the SC SUT; therefore, the signaling between the SC and media server is left to the vendor so long as the announcement is played and the signaling between the SC and AS-SIP EI complies with the specific call flow depicted in this section.

SIP-000400 When an SC receives an inbound INVITE from its primary SS where the Request-URI has a DSN telephone number for which the SC has no entry in its location server, then the SC MUST respond with a 404 (Not Found) response message. As the 404 (Not Found) response is forwarded to the originating SC, each intermediate SS responds to the 404 (Not Found) response with an ACK on a hop-by-hop basis. When the originating SC receives the 404 (Not Found) response, then the originating SC sends an ACK to its SS (SS A in [Figure 4.1-2](#), SC Implements Playing of VCA at AS-SIP EI) and is responsible for ensuring that the following occurs:

1. The EI plays the VCA: “Remote signaling switch.” Your call cannot be completed as dialed. Please consult your directory and call again or ask your operator for assistance. This is a recording. “Remote signaling switch.”
2. The EI is instructed to terminate the call. In the case of a SIP EI, the originating SC forwards the 404 (Not Found) response message after the VCA is played to the user.
3. In the case of an AS-SIP EI, the SC establishes a bearer connection between the AS-SIP EI and a media server associated with the SC. See [Figure 4.1-3](#), Originating SC Implements Playing of VCA at AS-SIP EI upon Receipt of 404 from Destination SC. The SC and media server exchange the necessary signaling to provide the media server with the IP address and UDP port for the bearer stream with the AS-SIP EI, and the SC instructs the media server to play the VCA over the bearer stream to the AS-SIP EI after the bearer is established. The 183 (Session Progress) response sent by the SC to the AS-SIP EI includes the sdp answer with the IP address and UDP port for a bearer stream with the media server. The AS-SIP EI responds with a PRACK to which the SC responds with a 200 (OK) response. The media server plays the announcement to the AS-SIP EI and terminates the session with the SC, and the SC sends a 404 (Not Found) response to the AS-SIP EI. The AS-SIP EI responds with an ACK and terminates the call request.

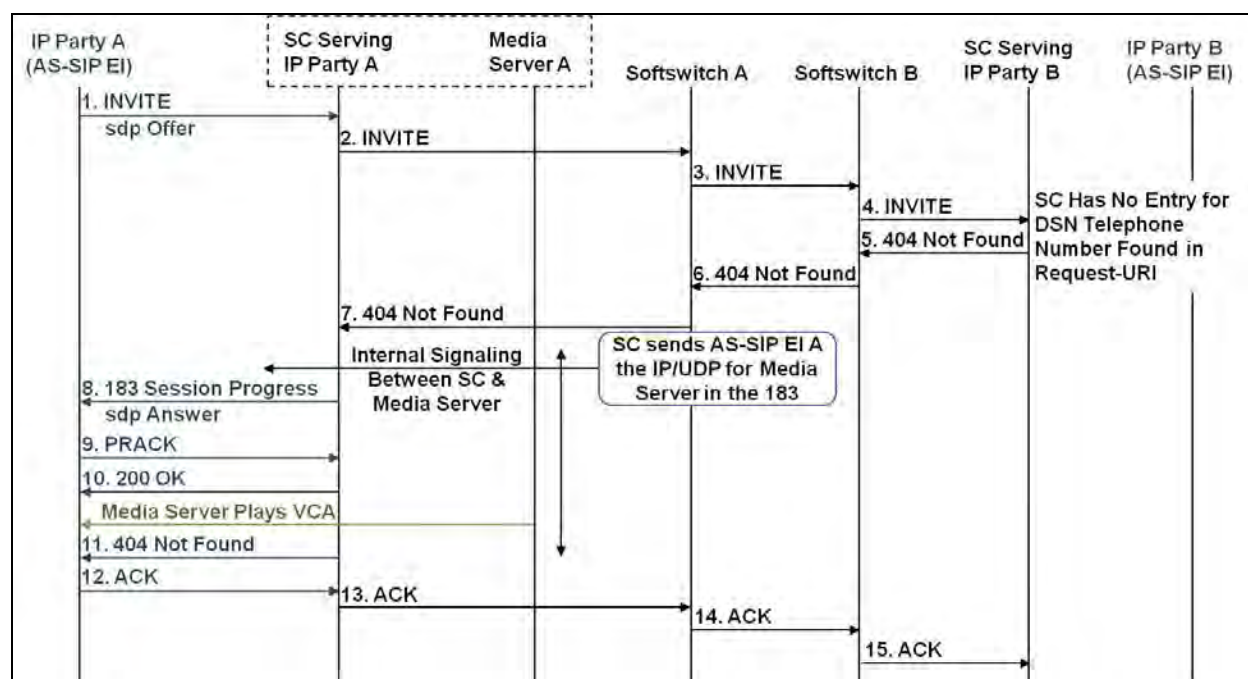

Figure 4.1-3. Originating SC Implements Playing of VCA at AS-SIP EI Upon Receipt of 404 Response From Destination SC

NOTE: The media server is considered a part of the SC SUT; therefore, the signaling between the SC and media server is left to the vendor as long as the announcement is played and the signaling between the SC and AS-SIP EI complies with the specific call flow depicted in this section.

4.1.6 Early Media

SIP-000410 When an originating SC (not serving an AS-SIP EI) receives an sdp answer (or offer in the case of an Empty INVITE) in a reliable first 18x response to an outbound INVITE, the SC MUST interpret this to mean that the call is being interworked and that the EI will receive early media in the backward RTP bearer path.

SIP-000410.a In all cases, a non-failure provisional message greater than 100 (e.g., any 18x message) that includes an sdp body MUST comply with RFC 3262. The 18x message with the sdp body MUST include an RSeq header and MUST contain a Require header field with the option tag “100rel.” The originating SC (not serving an AS-SIP EI) that is the recipient of the reliable 18x message with an sdp answer MUST respond with a PRACK that includes the Rack header. The originating SC (not serving an AS-SIP EI) that is the recipient of a reliable 18x message with an sdp offer (Empty INVITE) MUST respond with a PRACK that includes the Rack header and the sdp answer. The recipient of the PRACK MUST respond with a 200 (OK) PRACK.

NOTE: All AS-SIP signaling appliances and all AS-SIP EIs MUST support RFC 3262.

SIP-000420 When an originating AS-SIP EI receives an sdp answer in a reliable first 18x response to an outbound INVITE, the originating AS-SIP EI MUST interpret this to mean that the call is being interworked and that the originating AS-SIP EI will receive early media in the backward RTP bearer path.

SIP-000420.a The 18x message with sdp body MUST include an RSeq header and MUST contain a Require header field containing the option tag “100rel.” The AS-SIP EI that is the recipient of the reliable 18x message with the sdp body MUST respond with a PRACK that includes the Rack header, and then the recipient of the PRACK MUST respond with a 200 (OK) PRACK.

NOTE: The AS-SIP EIs MUST NOT generate Empty INVITEs; therefore, they cannot validly receive an sdp offer in the first 18x response.

SIP-000430 The originating SC (and the originating AS-SIP EI, if present) interprets the absence of an sdp answer in the first 18x response to an outbound INVITE to mean that the call is NOT being interworked, the early media is not going to be received by the EI in the backward bearer path, and the ringback must be generated locally.

SIP-000440 The originating SC interprets the absence of an sdp offer (in the case of an Empty INVITE) in the first 18x response to an outbound INVITE to mean that the call is NOT being interworked, the early media is not going to be received by the EI in the backward bearer path, and the ringback must be generated locally.

NOTE: The presence of preconditions in a call flow represents the single exception to this method by which the originating SC determines whether the EI will be receiving the

early media over the backward bearer path or generating the ringback locally, or whether the AS-SIP EI determines whether it will be receiving early media.

SIP-000450 In the case of preconditions, the first provisional response (> 100 trying) from the terminating SC or SS normally MUST contain an sdp regardless of whether the call is being interworked to the TDM network; therefore, when initiating a call with preconditions the originating SC cannot interpret the presence of the sdp in the first 18x response to mean that early media will be received on the bearer stream. To enable the originating SC to distinguish between calls using preconditions that are being interworked to the TDM network versus those calls that are not being interworked, the following modification is made to calls with preconditions that are NOT being interworked:

SIP-000450.a End-to-End Status Type Precondition

After the originating SC sends the INVITE with the sdp offer that includes precondition attributes and the remote side responds with a reliable 183 (Session Progress) response (including RSeq header and having a Require header field containing the option tag “100rel”) with the initial sdp answer, the originating SC sends the PRACK and the remote side sends the 200 (OK) PRACK, then if the terminating AS-SIP signaling appliance is an SC serving a called IP EI the terminating SC immediately sends a 183 (Session Progress) response without any sdp. (See Requirement SIP- and006140 and [Figure 9.2-3](#), Successful Basic IP-to-IP Call [End-to-End Precondition]). The presence of this 183 (Session Progress) response notifies the originating SC that the call is NOT being interworked. Conversely, when the terminating AS-SIP signaling appliance is interworking the call, then after sending the 200 (OK) response to the PRACK the terminating side refrains from sending any additional 18x AS-SIP responses until the terminating side receives the UPDATE message from the originating SC. (See Requirement SIP-010340 and Figure 16.2-6, Successful Basic IP-to-TDM Call [End-to-End Precondition]).

SIP-000450.b Segmented Status Type Precondition

When the terminating AS-SIP signaling appliance is an SC serving an IP EI, then the terminating SC initially responds with a 183 (Session Progress) response that does not have an sdp. This signals to the originating SC that the call is NOT being interworked. Upon successful completion of resource reservation, the terminating SC sends a reliable 180 (Ringing) response (including the RSeq header and a Require header field containing the option tag “100rel”) with the sdp answer that among other things confirms the successful resource reservation. The originating SC responds with a PRACK, and the terminating SC sends the 200 (OK) PRACK. See SIP-006150 and [Figure 9.2-4](#), Successful Basic IP-to-IP Call (Segmented Precondition).

NOTE: If the call is being interworked the interworking gateway does not send the 183 (Session Progress) response, rather it simply sends the reliable 180 (Ringing)

response with an sdp IAW RFC 3312. The originating SC responds with a PRACK and the terminating SC sends a 200 (OK) PRACK. The absence of the 183 (Session Progress) response without an sdp body before the reliable 180 (Ringing) response with an sdp body that includes the precondition will signify to the originating AS-SIP signaling appliance that early media will be sent to the EI over the backward bearer path (See SIP-010360 and Figure 16.2-6, Successful Basic IP-to-TDM Call [Segmented Precondition]).

SIP-000460 The SCs serving IP EIs MUST ensure that all outbound INVITEs forwarded onto the UC WAN include a Supported header with the option tag “100rel.”

SIP-000460.a The AS-SIP EIs MUST include a Supported header with the option tag “100rel” in all outbound INVITEs.

NOTE: The AS-SIP EIs and SCs serving IP EIs MUST NOT place the option tag “100rel” in the Require header of an outbound INVITE.

NOTE: All AS-SIP signaling appliances and all AS-SIP EIs MUST support RFC 3262.

SIP-000470 When an AS-SIP signaling appliance receives an INVITE (having an sdp offer) and it will be interworking the signaling to the TDM network, then the AS-SIP signaling appliance MUST return an sdp answer in the first non-failure reliable provisional response. This 18x reliable response MUST comply with RFC 3262. For example:

IP EI ➔ SC A ➔ SS A ➔ SS B ➔ EO ➔ analog EI

IP EI ➔ SC A ➔ SS A ➔ SS B 18x reliable response

In this example, SS B performs the signal interworking between SIP and SS7 ISUP or Integrated Services Digital Network (ISDN); therefore, SS B MUST return an sdp answer in the first 18x response.

SIP-000470.a When the originating SC (that is not serving an AS-SIP EI) receives an sdp answer in a reliable first 18x response, then the originating SC MUST respond with an RFC 3262-compliant PRACK (to which the terminating SC or SS will respond with a 200 (OK) response). The originating EI MUST listen to the bearer stream for early media and MUST NOT generate local tones and announcements UNLESS the originating SC subsequently receives a SIP message in the signaling plane that requires the originating SC to instruct the IP EI to play an announcement locally.

SIP-000470.a.1 When an originating AS-SIP EI receives an sdp answer in a reliable first 18x response, then the originating AS-SIP EI MUST respond with an RFC 3262-compliant PRACK (to which the terminating SC or SS will respond with a 200 (OK) response). The AS-SIP EI MUST listen to the bearer stream for early media and MUST NOT generate local tones UNLESS the originating AS-

SIP EI subsequently receives an AS-SIP message in the signaling plane that requires it to play a tone locally.

SIP-000480 When an SC receives an INVITE (having an sdp offer) intended for a served IP EI, then the AS-SIP signaling appliance **MUST NOT** return an sdp answer in any provisional response and **MUST** only place the sdp answer in the 200 (OK) response.

SIP-000480.a When the originating SC (and originating SIP IP EI, if applicable) does not receive an sdp answer in the first 18x response, then the originating SC **MUST** instruct the originating IP EI to generate local tones and announcements, as required, and the IP EI does not listen for early media over the bearer stream.

SIP-000490 When an AS-SIP EI receives an INVITE (having an sdp offer), then the AS-SIP EI **MUST NOT** return an sdp answer in any provisional response and **MUST** only place the sdp answer in the 200 (OK) response.

SIP-000490.a When the AS-SIP EI does not receive an sdp answer in the first 18x response, then the AS-SIP EI **MUST** generate local tones, as required, and the AS-SIP EI does not listen for early media over the bearer stream.

4.1.6.1 Early Media and Empty INVITE

SIP-000500 When an AS-SIP signaling appliance receives an Empty INVITE (i.e., an INVITE that does not include an sdp offer) and said AS-SIP signaling appliance will be interworking the signaling to the TDM network, then the AS-SIP signaling appliance **MUST** send an sdp offer in the first reliable non-failure provisional response (1xx response code greater than a 100 response code). This 18x response **MUST** comply with RFC 3262.

SIP-000500.a When the originating SC receives an sdp offer in the reliable first 18x response, then the originating SC **MUST** respond with a PRACK per RFC 3262 that also includes an sdp answer (to which the interworking SC or SS will respond with a 200 (OK) response) and the originating SC, **MUST** ensure that the originating EI listens to the bearer stream for early media and **MUST NOT** generate local tones and announcements **UNLESS** the originating SC subsequently receives a SIP message in the signaling plane that requires the originating SC to instruct the IP EI to play an announcement locally.

SIP-000510 When an AS-SIP signaling appliance receives an Empty INVITE intended for a served IP EI, then the AS-SIP signaling appliance **MUST NOT** send an sdp offer in any provisional response (1xx response code greater than a 100 response code) and **MUST** only send the sdp offer in the 200 (OK) response.

SIP-000510.a When the originating SC does not receive an sdp offer in the first 18x response, then the originating SC **MUST** instruct the originating EI to generate local tones and announcements, as required, and the IP EI does not listen for early media over the bearer stream.

SIP-000520 When an AS-SIP EI receives an Empty INVITE, it MUST NOT send an sdp offer in any provisional response (1xx response code greater than a 100 response code) and MUST only send the sdp offer in the 200 (OK) response.

See [Section 6.3](#), ASAC Rule Set, for requirements relating to Empty INVITE and Assured Services Admission Control (ASAC) call count.

4.1.6.2 Interworking Early Media to the TDM Network

This section describes calling from the TDM network to establish sessions in the IP network.

SIP-000530 When an AS-SIP signaling appliance that is interworking SIP signaling with the TDM network receives a 180 (Ringing) response from the IP network, the AS-SIP signaling appliance MUST ensure that the appropriate ringback tone (e.g., ringback, precedence ringback) is generated on the TDM network.

NOTE: [Section 12](#), TDM-SIP Translation Requirements for Interworking AS-SIP Signaling Appliances, details the interworking for the 180 (Ringing) response in the signaling plane.

SIP-000540 Announcements are not sent in-band on the DSN TDM network; therefore, when an AS-SIP signaling appliance that is interworking SIP signaling with the TDM network receives a 480 (Temporarily Unavailable), 486 (Busy Here), or 488 (Not Acceptable Here) response from the IP network with either no Reason header or a Reason header that does NOT have a preemption cause, the AS-SIP signaling appliance does NOT generate an announcement to be sent to the TDM network, rather it sends either a REL with Q.850 cause code 46 precedence call blocked (in the case of SS7 ISUP) or a Disconnect (in the case of ISDN) with the appropriate cause code message to the TDM network.

If a precedence call cannot be established in the IP network because the IP resources are being used by the same or higher precedence traffic in the IP network, the cause code will be sent to the TDM network with a Q.850 cause code 46 precedence call blocked (in the case of ISDN).

4.1.7 Media Feature Tags

SIP-000550 An SC that receives an outbound call request from a served IP EI MAY include an audio media feature tag and a video media feature tag, as appropriate, in the Contact header field of the INVITE message (RFC 3840).

SIP-000560 The AS-SIP signaling appliances are NOT required to process and act on the audio media tag and the video media tag in the Contact header but all intermediary AS-SIP signaling appliances MUST preserve the audio media tag (if present) and the video tag (if present) when forwarding the INVITE (i.e., intermediary AS-SIP signaling appliances MUST NOT strip off or modify the media feature tags).

4.1.8 P-Asserted-Identity

SIP-000570 When an SC receives a call request from a served IP EI intended for a destination outside the enclave, then the AS-SIP signaling appliance MUST generate the P-Asserted-Identity header as follows:

SIP-000570.a If the identity of the caller is known, then the PAssertedID-value MUST include the name-addr field, e.g., the name of the caller in double quotes per RFC 3325.

SIP-000570.b The PAssertedID-value MUST always contain the SIP URI of the calling EI whereby the userinfo part includes the full 10-digit DSN number.

Examples:

P-Asserted-Identity: "John Anderson" <sip:3121234567@uc.mil;user=phone>

P-Asserted-Identity: <sip:3121234567@uc.mil;user=phone>

4.2 SIP METHODS

4.2.1 INVITE Request

SIP-000580 The SCs and AS-SIP EIs MUST support generating and receiving SIP INVITE requests.

SIP-000590 The SCs and AS-SIP EIs MUST comply with the requirements of RFC 3261. (RFC 3261, Sections 13.2.1, Creating the Initial INVITE; 13.2.2, Processing the INVITE Responses; and 13.3.1, Processing of the INVITE.)

SIP-000600 The SCs and AS-SIP EIs MUST support the generating and receiving of SIP re-INVITE requests (RFC 3261, Section 14, Modifying and Existing Session).

4.2.2 CANCEL Request

SIP-000610 The SCs and AS-SIP EIs MUST support the generating, receiving, and processing of SIP CANCEL requests (RFC 3261, Sections 16.7, Response Processing, and 16.10, CANCEL Processing).

4.2.3 REGISTER Request

4.2.3.1 AS-SIP EI Creation of Register Request

SIP-000620 The AS-SIP EIs MUST generate Register requests (and send the Register requests to the serving SC/Registrar) in compliance with RFC 3261, Section 10.2, Constructing the REGISTER Request where:

SIP-000620.a The Request-URI MUST consist of the Fully Qualified Domain Name (FQDN) for the domain to which both the SC/Registrar and the AS-SIP EI belong.

NOTE: The userinfo part and the “@” are not present in the Request-URI of the Register request.

SIP-000620.b The To header field MUST contain the address of record for the AS-SIP EI; specifically a SIP URI where the userinfo part consists of the 10-digit DSN number for the AS-SIP EI and the hostname consists of the FQDN for the domain in which the AS-SIP EI resides.

SIP-000620.c The From header field MUST contain the address of record for the AS-SIP EI; specifically a SIP URI where the userinfo part consists of the 10-digit DSN number for the AS-SIP EI and the hostname consists of the FQDN for the domain in which the AS-SIP EI resides.

SIP-000620.d The AS-SIP EI SHOULD use the same value for the Call-ID header for all registrations sent to a given SC/Registrar.

SIP-000620.e The AS-SIP EI MUST increment the CSeq value by one for each Register request with the same Call-ID.

SIP-000630 The initial Register request MUST include a Contact header having the following SIP URI contact addresses:

SIP-000630.a SIP URI where the userinfo part is the 10-digit DSN number for the AS-SIP EI and where the hostname is the IPv4 address of the AS-SIP EI.

SIP-000630.b SIP URI where the userinfo part is the 10-digit DSN number for the AS-SIP EI and where the hostname is the IPv6 address of the AS-SIP EI.

SIP-000640 The AS-SIP EIs MUST NOT send a new Register request until a final response from the Registrar has been received for the previous Register request or until the previous Register request has timed out.

SIP-000650 The AS-SIP EIs MAY include the “expires” parameter along with a SIP URI of a contact address in the Contact header where the “expires” parameter indicates how long the AS-SIP EI would like the binding to be valid without a refresh. The Registrar will treat malformed values for the “expires” parameter as having a value of 3600 seconds.

SIP-000650.a In the absence of an “expires” parameter in the Contact header, the presence of an Expires header in the Register request represents the length of the interval the AS-SIP EI would like the binding to be valid without a refresh.

NOTE: The AS-SIP EI is NOT required to include either “expires” parameters with contact addresses and is NOT required to include an Expires header.

SIP-000660 5 When an AS-SIP EI wishes to immediately remove a current binding for a contact address, the AS-SIP EI MUST issue a new Register request with “expires” parameter with a value of “0” for the contact address whose binding is being immediately terminated.

SIP-000670 AS-SIP EIs MUST support the capability to send a Register request with a contact value of ‘*’ and an Expires header with the value ‘0’ which removes all bindings associated with the address of record.

It is understood that the use of a Register request with a contact value of ‘*’ and an Expires header with the value ‘0’ to remove all bindings associated with an address of record may result in unintended network consequences for end users having more than one registered EI (AS-SIP and/or non-AS-SIP), therefore AS-SIP EI vendors MAY provide the capability to restrict the generation of this type of Register request to network administrators in which case network administrators MUST have the concomitant ability to enable/disable this type of register request for end users of the AS-SIP EI.

NOTE: The “*” Contact header value MUST NOT be used unless the Expires header is present and set to “0”.

SIP-000680 The AS-SIP EIs MAY include “q” parameters with the contact addresses rank the various bindings.

SIP-000690 Since registrations expire unless refreshed, the AS-SIP EIs MUST refresh the bindings it has established before the expiration of the bindings; otherwise, the bindings time-out and are removed from the Registrar database.

SIP-000700 [Conditional] It is a conditional requirement that an AS-SIP EI include a "sip.instance" media feature tag which appears as a “+sip.instance” Contact header field parameter in the Register request and a “reg-id” Contact header field parameter in the Register request (see RFC 5626 Managing Client-Initiated Connections in the Session Initiation Protocol [SIP]).

NOTE: The instance-id (i.e., the value of the “sip.instance” media feature tag) is used by the Registrar/SC to uniquely identify the registering EI.

SIP-000700.a [Conditional] If an AS-SIP EI includes a "sip.instance" media feature tag in the Contact header of the Register request then the instance-id MUST be a Uniform Resource Name (URN) that provides a globally unique instance ID that uniquely identifies the AS-SIP EI and that persists across power cycles.

SIP-000700.b [Conditional] When present the instance-id SHOULD be a RFC 4122 compliant Universally Unique Identifier (UUID). In addition if the AS-SIP EI has at least 1 MAC address then it is RECOMMENDED that the instance-id be a version 1 UUID whereby the node field consists of an Institute of Electrical and Electronics Engineers (IEEE) 802 MAC address belonging to the AS-SIP EI.

Example from RFC 5626 sec. 3.2 of a Contact header with a “sip.instance” parameter and a “reg-id” parameter:

```
Contact: <sip:line1@192.0.2.2;transport=tcp>; reg-id=1;  
+sip.instance="<urn:uuid:00000000-0000-1000-8000-000A95A0E128>
```

4.2.3.2 Registrar Processing of Register Request

SIP-000710 The SC/Registrars MUST receive/process Register requests received from AS-SIP EIs in compliance with RFC 3261, Section 10, Registrations.

SIP-000720 The default requirement for SC/Registrar authentication of the AS-SIP EI is the successful establishment of the TCP/TLS connection between the AS-SIP EI and the SC/Registrar. User authentication is NOT a default requirement of the registration process.

SIP-000720.a However, the UCR does not preclude user authentication either upon receipt of a Register request from an AS-SIP EI for which the Registrar has no current bindings or even when the AS-SIP EI is renewing, adding, or removing bindings. If a Registrar is configured to engage in user authentication, then the Registrar uses RFC 3261, Section 22, Usage of HyperText Transfer Protocol (HTTP) Authentication, and in particular the Registrar sends the 401 (Unauthorized) response that includes the WWW-Authenticate response header field to the AS-SIP EI, which MUST resend the Register request with the Authorization header field. The AS-SIP EI MUST also increment the CSeq header field when it resends the Register request with the Authorization header field.

SIP-000720.a.1 If the authenticated user attempts to modify a binding but is not authorized to modify bindings, the Registrar MUST return a 403 (Forbidden) response.

SIP-000730 When the Registrar receives a Register request and the address of record found in the To header is not valid for the domain in the Request-URI, then the Registrar responds to the AS-SIP EI with a 404 (Not Found) response.

SIP-000740 When the Registrar receives a Register request and the address of record found in the To header is valid for the domain in the Request-URI, then the Registrar looks for a Contact header in the Register request. If no Contact header is present, then the Registrar responds with a 200 (OK) response with Contact header field values for all current bindings and an “expires” value set by the Registrar for each contact binding. The response SHOULD include a Date header field to enable the AS-SIP EI to keep synchronized with the Registrar for determining the expiration of a binding.

SIP-000740.a If the Register request has a Contact header with a contact value “*” but either there are additional contact values or the Expires header has an expiration time that

is not zero, then the request is invalid and the Registrar responds with a 400 (Invalid Request) response.

SIP-000740.b If the Register request has a Contact header with a contact value “*” and an Expires header with the value “0,” then the following actions **MUST** be taken for EACH binding the Registrar contains for the address of record in the request:

SIP-000740.b.1 If the Call-ID of the Register request does not match the Call-ID associated with a particular binding, then the binding is removed.

SIP-000740.b.2 If the Call-ID stored with the binding matches the Call-ID of the current Register request and the CSeq of the current Register request is greater than the CSeq stored with the binding, then the binding is removed.

SIP-000740.b.3 If the Call-ID stored with the binding matches the Call-ID of the current Register request and the CSeq of the current Register request is less than the CSeq stored with the binding, then the update is aborted and the request fails. The Registrar responds with a 500 (Server Error) response, and all changes made pursuant to the Register request **MUST** be reversed and the bindings restored to their previous values.

SIP-000740.c If the Register request has a Contact header with enumerated contact address bindings, then:

SIP-000740.c.1 The Registrar sets an expiration interval for each contact address binding. The Registrar recognizes the “expires” parameter, if present, as indicating the requested expiration interval for the associated contact address. If an “expires” parameter is not present for a given contact address, then if an Expires header is present the value of the Expires header is treated as the requested expiration interval. If neither is present, then the requested expiration is the locally configured default expiration value at the Registrar.

SIP-000740.c.2 The Registrar **MAY** set the expiration to a value less than the requested expiration interval.

SIP-000740.c.3 The Registrar **MAY** reject the Register request if the requested expiration value is greater than 0, but less than 3600 (i.e., 1 hour) and less than the minimum interval configured at the Registrar. The Registrar responds with a 423 (Interval Too Brief) response that includes a Min-Expires header with the minimum acceptable expiration interval.

SIP-000740.c.3.a If an AS-SIP EI receives a 423 (Interval Too Brief) response, the AS-SIP EI **MAY** retry the registration after making the expiration interval of all contact addresses in the REGISTER request equal to or greater than the value expiration interval in the Min-Expires header field of the 423 (Interval Too Brief) response.

SIP-000740.c.4 The Registrar removes bindings when the “expires” parameter for the contact address is zero.

SIP-000740.c.5 The Registrar adds new bindings for contact addresses that do not currently exist in the database.

SIP-000740.c.6 If a binding does exist, then the Registrar checks the Call-ID value. If the Call-ID value in the existing binding differs from the Call-ID value in the request, the binding **MUST** be removed if the expiration time in the contact address in the Register request is zero and updated otherwise.

SIP-000740.c.7 If a binding does exist and the Call-ID value of the existing binding matches that of the Register request and the CSeq value for the Register request is higher than that of the existing binding, then the binding **MUST** be removed if the expiration time in the contact address in the Register request is zero and updated otherwise.

SIP-000740.c.8 If a binding does exist and the Call-ID value of the existing binding matches that of the Register request and the CSeq value for the Register request is lower than that of the existing binding, then the update is aborted and the request fails. The Registrar responds with a 500 (Server Error) response, and all changes made pursuant to the Register request **MUST** be reversed and the bindings restored to their previous values.

SIP-000750 For each binding, the Registrar stores the Call-ID and CSeq values from the request.

SIP-000760 When a Registrar returns a 200 (OK) response, then the response **MUST** contain Contact header field values enumerating all current bindings. Each contact value **MUST** feature an “expires” parameter indicating its expiration interval chosen by the Registrar. The response **SHOULD** include a Date header field.

SIP-000770 When an AS-SIP EI receives the 200 (OK) response from the Registrar, the AS-SIP EI confirms that it created the contact address and, if so, updates the expiration time interval according to the “expires” parameter or, if the “expires” parameter is absent, the value of the Expires header field.

SIP-000780 [Conditional] It is a conditional requirement that a Registrar be capable of processing a "sip.instance" media feature tag and a “reg-id” Contact header field parameter. When a Registrar that does not support processing of the “sip.instance” media feature tag and the “reg-id” Contact header field parameter receives a Register request that includes a “sip.instance” media feature tag and a “reg-id” parameter then the Registrar processes the Contact header but ignores these parameters.

NOTE: The Registrar function does not refer to a registration process between the SC and the SS.

4.2.4 OPTIONS Request

SIP-000790 The SCs and AS-SIP EIs **MUST** comply with the requirements of RFC 3261, Section 11, Querying for Capabilities, which includes 11.1, Construction of OPTIONS Request, and 11.2, Processing of OPTIONS Request.

SIP-000790.a SSs **MUST** comply with the requirements of RFC 3261, Section 11, Querying for Capabilities, which includes 11.1, Construction of OPTIONS Request, and 11.2, Processing of OPTIONS Request. Softswitches **MUST** respond to SIP OPTIONS requests when the SS is identified in the Request-URI or when the SS receives an OPTIONS request in which the Max-Forwards header field value is zero.

NOTE: The OPTIONS request is used by SCs as a component of the SS failover mechanism; the complete requirements are found in UCR 2013, Section 2 5.3.2, Session Control Products.

4.2.5 BYE Request

SIP-000800 The SCs and AS-SIP EIs **MUST** support the generating and receiving of SIP BYE requests and **MUST** comply with the requirements of RFC 3261 (RFC 3261, Section 15, Terminating a Session).

4.2.6 ACK Request

SIP-000810 The SCs and AS-SIP EIs **MUST** support generating and receiving SIP ACK requests (RFC 3261).

4.2.7 PRACK Request

SIP-000820 The SCs and AS-SIP EIs **MUST** support generating and receiving the SIP PRACK method (RFC 3262).

SIP-000830 The SCs and AS-SIP EIs **MUST** support the use of the option tag “100rel” with the Require and Supported header fields, and **MUST** support the use of the Rack and RSeq header fields (RFC 3262).

4.2.8 UPDATE Request

SIP-000840 The SCs and AS-SIP EIs **MUST** support the generating and receiving of the SIP UPDATE method. (RFC 3311) In particular, in this specification UPDATE is recommended for refreshing the SIP session timer, is used in the alternative call transfer call flows that do not use the REFER method, and is used in the optional end-to-end precondition call flow.

4.2.9 REFER Request

SIP-000850 The SCs and AS-SIP EIs **MUST** be capable of receiving or processing REFER requests.

SIP-000860 The SCs and AS-SIP EIs **MAY** generate REFER requests when acting in the capacity of the transferor in the call transfer supplementary service.

SIP-000870 “A proxy [e.g., an SC] should process a REFER request the same way it processes an OPTIONS request” (RFC 3515, Section 2.6, Behavior of SIP Proxies).

4.2.10 SUBSCRIBE Request

SIP-000880 The SCs and AS-SIP EIs **MUST** support generating and receiving the SUBSCRIBE method for event notification (RFC 3265).

4.2.11 NOTIFY Request

SIP-000890 The SCs and AS-SIP EIs **MUST** support the NOTIFY method for event notification (RFC 3265). In particular, this specification uses the NOTIFY request in the call transfer supplementary service (see [Section 9](#), Calling Services).

4.2.12 SIP INFO Method

SIP-000900 SCs **MAY** generate RFC 2976 compliant SIP INFO requests on behalf of non-AS-SIP EIs.

SIP-000910 AS-SIP EIs (and SIP EIs) **MAY** generate RFC 2976 SIP INFO requests.

NOTE: Per RFC 2976 SIP INFO Method, “The INFO method is not used to change the state of SIP calls, or the parameters of the sessions SIP initiates.”

SIP-000920 When an SC receives a SIP INFO request intended for a served non-AS-SIP EI that contains a body that the SC does not understand then the SC **SHALL** respond with a 415 Unsupported Media Type response code.

SIP-000930 When an AS-SIP EI (or SIP EI) receives a SIP INFO request that contains a body that the AS-SIP EI (or SIP EI) does not understand then the AS-SIP EI (or SIP EI) **SHALL** respond with a 415 Unsupported Media Type response code.

SIP-000940 A SS that receives a SIP INFO request **SHALL** transparently forward the SIP INFO request onward unless the call-ID, To tag and From tag (i.e. dialog ID) do not match an existing call in which case the SS responds with a 481 Call Leg/Transaction Does Not Exist.

SIP-000950 A SC that receives a SIP INFO request from a served AS-SIP EI (or SIP EI) **SHALL** transparently forward the SIP INFO request onward unless the call-ID, To tag and From

tag (i.e. dialog ID) do not match an existing call in which case the SC responds with a 481 Call Leg/Transaction Does Not Exist.

SIP-000960 A SC that receives a SIP INFO request intended for a served AS-SIP EI (or SIP EI) SHALL transparently forward the SIP INFO request to the AS-SIP EI (or SIP EI) unless the call-ID, To tag and From tag (i.e. dialog ID) do not match an existing call in which case the SC responds with a 481 Call Leg/Transaction Does Not Exist.

4.3 SIP HEADER FIELDS

SIP-000970 [Table 4.3-1](#) and [Table 4.3-2](#) (from RFC 3261) identify the header fields specified in RFC 3261. For the reader's convenience, a description of the symbols used in the tables augmented by header fields specified in subsequent SIP extensions are provided in [Table 4.3-1](#), Summary of Header Fields, A-Z, and the following text (RFC 3261, Section 20, Header Fields).

The **where** column values are:

- R: The header field may only appear in requests.
- r: The header field may only appear in responses.
- 2xx, 4xx, etc.: A numerical value or range that indicates response codes with which the header field can be used.
- c: The header field is copied from the request to the response.
- c(1): The header field is copied with the addition of a tag.

An empty entry in the **where** column indicates that the header field may be present in all requests and responses.

The **proxy** column describes the operations a proxy may perform on a header field:

- a: A proxy can add or concatenate the header field if not present.
- m: A proxy can modify an existing header field value.
- d: A proxy can delete a header field value.
- r: A proxy must be able to read the header field; thus, this header field cannot be encrypted.

The next six columns relate to the presence of a header field in a method:

- c: Conditional; the requirements on the header field depend on the context of the message.
- m: The header field is mandatory.
- m*: The header field SHOULD be sent, but clients or servers need to be prepared to receive messages without that header field.
- o: The header field is optional.
- t: The header field SHOULD be sent, but clients/servers need to be prepared to receive messages without that header field.

If a stream-based protocol, such as TCP, is used as a transport, then the header field MUST be sent.

- *: The header field is required if the message body is not empty.
- : The header field is not applicable.

The underlined entries signify the minimum set of header fields that MUST be supported by at least one category of an AS-SIP signaling appliance.

Table 4.3-1. Summary of Header Fields, A–Z (Part 1)

HEADER FIELD	WHERE	PROXY	ACK	BYE	CAN	INV	OPT	REG
<u>Accept</u>	R		-	o	-	o	m*	o
<u>Accept</u>	2xx		-	-	-	o	m*	o
<u>Accept</u>	415		-	c	-	c	c	c
Accept-Contact	R	a r	o	o	o	o	o	-
Accept-Encoding	R		-	o	-	o	o	o
Accept-Encoding	2xx		-	-	-	o	m*	o
Accept-Encoding	415		-	c	-	c	c	c
Accept-Language	R		-	o	-	o	o	o
Accept-Language	2xx		-	-	-	o	m*	o
Accept-Language	415		-	c	-	c	c	c
Accept-Resource-Priority	200	a m d r	-	o	o	o	o	o
Accept-Resource-Priority	417	a m d r	-	o	o	o	o	o
<u>Alert-Info</u>	R	a r	-	-	-	o	-	-
<u>Alert-Info</u>	180	a r	-	-	-	m	-	-
<u>Allow</u>	R		-	o	-	o	o	o

HEADER FIELD	WHERE	PROXY	ACK	BYE	CAN	INV	OPT	REG
<u>Allow</u>	2xx		-	o	-	m*	m*	o
<u>Allow</u>	r		-	o	-	o	o	o
<u>Allow</u>	405		-	m	-	m	m	m
<u>Allow-Events</u>	R		o	o	-	o	o	o
<u>Allow-Events</u>	2xx		-	o	-	o	o	o
<u>Allow-Events</u>	489		-	-	-	-	-	-
Authentication-Info	2xx		-	o	-	o	o	o
<u>Authorization</u>	R	m	m	m	m	m	m	
<u>Call-ID</u>	c	r	m	m	m	m	m	m
Call-Info	a r		-	-	-	o	o	o
<u>Contact</u>	R		o	-	-	m	o	o
<u>Contact</u>	1xx		-	-	-	o	-	-
<u>Contact</u>	2xx		-	-	-	m	o	o
<u>Contact</u>	3xx	d	-	o	-	o	o	o
<u>Contact</u>	485		-	o	-	o	o	o
<u>Content-Disposition</u>			o	o	-	o	o	o
<u>Content-Encoding</u>			o	o	-	o	o	o
<u>Content-Language</u>			o	o	-	o	o	o
<u>Content-Length</u>		a r	t	t	t	t	t	t
<u>Content-Type</u>			*	*	-	*	*	*
<u>Cseq</u>	c	r	m	m	m	m	m	m
<u>Date</u>		a	o	o	o	o	o	o
Error-Info	300-699	a	-	o	o	o	o	o
<u>Event</u>	R		-	-	-	-	-	-
<u>Expires</u>			-	-	-	o	-	o
<u>From</u>	c	r	m	m	m	m	m	m
In-Reply-To	R		-	-	-	o	-	-
Join	R		-	-	-	o	-	-
<u>Max-Forwards</u>	R	a m r	m	m	m	m	m	m
<u>Min-Expires</u>	423		-	-	-	-	-	m
<u>Min-SE</u>	R	a m r	-	-	-	o	-	-
<u>Min-SE</u>	2xx	a r	-	-	-	o	-	-
MIME-Version			o	o	-	o	o	o
Organization	ar		-	-	-	o	o	o
P-Access-Network-Info	dr		-	o	-	o	o	o

HEADER FIELD	WHERE	PROXY	ACK	BYE	CAN	INV	OPT	REG
<u>P-Asserted-Identity</u>	adr		-	o	-	o	o	-
P-Associated-URI	2xx		-	-	-	-	-	o
P-Called-Party-ID	R	a m r	-	-	-	o	o	-
P-Charging-Function-Addresses	adr		-	o	-	o	o	o
P-Charging-Vector	admr		-	o	-	o	o	o
P-DCS-Billing-Info	admr		-	-	-	o	-	-
P-DCS-LAES	adr		-	-	-	o	-	-
P-DCS-OSPS	R	d r	-	-	-	o	-	-
P-DCS-Redirect		a d r	-	-	-	o	-	-
P-DCS-Trace-Party-ID	R	d r	-	-	-	o	-	-
P-Media-Authorization	R	a d	o	-	-	o	-	-
P-Media-Authorization	2xx	a d	-	-	-	o	-	-
P-Media-Authorization	101-199	a d	-	-	-	o	-	-
Path	R	a r	-	-	-	-	-	o
Path	2xx		-	-	-	-	-	o
P-Preferred-Identity		a d r	-	o		o	o	-
Priority	R	a r	-	-	-	o	-	-
Privacy		a m r d	o	o	o	o	o	o
<u>Proxy-Authenticate</u>	407	a r	-	m	-	m	m	m
<u>Proxy-Authenticate</u>	401	a r	-	o	o	o	o	o
<u>Proxy-Authorization</u>	R	d r	o	o	-	o	o	o
<u>Proxy-Require</u>	R	a r	-	o	-	o	o	o
P-Visited-Network-ID	R	a d	-	-	-	o	o	o
<u>Rack</u>	R		-	-	-	-	-	-
<u>Reason</u>	R		o	o	o	o	o	o
<u>Record-Route</u>	R	a r	o	o	o	o	o	-
<u>Record-Route</u>	2xx,18x	m r	-	o	o	o	o	-
<u>Refer-To</u>	R		-	-	-	-	-	-
<u>Referred-By</u>	R		-	o	-	o	o	o
Reject-Contact	R	a r	o	o	o	o	o	-
<u>Replaces</u>	R		-	-	-	o	-	-
Reply-To			-	-	-	o	-	-
Request-Disposition	R	a r	o	o	o	o	o	o
<u>Require</u>	a r		-	c	-	c	c	c
Resource-Priority	R	a m d r	o	o	o	o	o	o

HEADER FIELD	WHERE	PROXY	ACK	BYE	CAN	INV	OPT	REG
<u>Retry-After</u>	404,413,480,486		-	o	o	o	o	o
	500,503		-	o	o	o	o	o
	600,603		-	o	o	o	o	o
<u>Route</u>	R	a d r	c	c	c	m	c	c
<u>Rseq</u>								
Security-Client	R	a r d	-	o	-	o	o	o
Security-Server	421,494		-	o	-	o	o	o
Security-Verify	R	a r d	-	o	-	o	o	o
Server	r		-	o	o	o	o	o
Service-Route	2xx	a r	-	-	-	-	-	o
<u>Session-Expires</u>	422		-	-	-	m	-	-
<u>Session-Expires</u>	422		-	-	-	m	-	-
SIP-Etag	2xx		-	-	-	-	-	-
SIP-If-Match	R		-	-	-	-	-	-
Subject	R		-	-	-	o	-	-
<u>Subscription-State</u>	R		-	-	-	-	-	-
<u>Supported</u>	R		-	o	o	m*	o	o
<u>Supported</u>	2xx		-	o	o	m*	m*	o
Timestamp			o	o	o	o	o	o
<u>To</u>	c(1)	r	m	m	m	m	m	m
<u>Unsupported</u>	420		-	m	-	m	m	m
User-Agent			o	o	o	o	o	o
<u>Via</u>	R	a m r	m	m	m	m	m	m
<u>Via</u>	rc	d r	m	m	m	m	m	m
<u>Warning</u>	r		-	o	o	o	o	o
<u>WWW-Authenticate</u>	401	a r	-	m	-	m	m	m
<u>WWW-Authenticate</u>	407	a r	-	o	-	o	o	o

Table 4.3-2. Summary of Header Fields, A–Z (Part 2)

HEADER FIELD	WHERE	PROXY	PRA	UPD	SUB	NOT	INF	MSG	REF	PUB
<u>Accept</u>	R		o		o	o			o	o
<u>Accept</u>	2xx		-		-	-			-	-
<u>Accept</u>	415		c		o	o			c	m*
Accept-Contact	R	ar	o	o	o	o	o	o	o	
Accept-Encoding	R		o		o	o			o	o

HEADER FIELD	WHERE	PROXY	PRA	UPD	SUB	NOT	INF	MSG	REF	PUB
Accept-Encoding	2xx		-		-	-			-	-
Accept-Encoding	415		c		o	o			c	m*
Accept-Language	R		o		o	o			o	o
Accept-Language	2xx		-		-	-			-	-
Accept-Language	415		c		o	o			c	m*
Accept-Resource-Priority	200	a m d r	o	o	o	o	o	o	o	o
Accept-Resource-Priority	417	a m d r	o	o	o	o	o	o	o	o
<u>Alert-Info</u>	R		-		-	-			-	-
<u>Alert-Info</u>	180		-		-	-			-	-
<u>Allow</u>	R		o		o	o			o	o
<u>Allow</u>	2xx		o		o	o				
<u>Allow</u>	r		o		o	o			o	o
<u>Allow</u>	405		m		m	m			m	m
<u>Allow-Events</u>	R									o
<u>Allow-Events</u>	2xx									
<u>Allow-Events</u>	489									m
Authentication-Info	2xx		o		o	o			o	o
<u>Authorization</u>	R		o		o	o			o	o
<u>Call-ID</u>	c		m		m	m			m	m
Call-Info			-						-	o
<u>Contact</u>	R		-		m	m			m	-
<u>Contact</u>	1xx		-		o	o			-	-
<u>Contact</u>	2xx		-		m	o			m	-
<u>Contact</u>	3xx		o		m	m			o	o
<u>Contact</u>	485		o		o	o			o	o
<u>Contact</u>	3xx-6xx								o	o
<u>Content-Disposition</u>			o		o	o			o	o
Content-Encoding	o				o	o			o	o
Content-Language			o		o	o			o	o
<u>Content-Length</u>			t		t	t			o	t
<u>Content-Type</u>			*		*	*			*	*
<u>Cseq</u>	c		m		m	m			m	m
<u>Date</u>			o		o	o			o	o
Error-Info	300-699		o		o	o			o	o
<u>Event</u>	R									m

HEADER FIELD	WHERE	PROXY	PRA	UPD	SUB	NOT	INF	MSG	REF	PUB
<u>Expires</u>			-		o	-			o	o
<u>Expires</u>	2xx				-	m			-	m
<u>From</u>	c		m		m	m			m	m
<u>In-Reply-To</u>	R		-		-	-			-	-
<u>Join</u>	R		-	-	-	-	-	-	-	-
<u>Max-Forwards</u>	R		m		m	m			m	m
<u>Min-Expires</u>	423		-		m	-			-	m
<u>Min-SE</u>	R	a m r	-	o	-	-				
<u>Min-SE</u>	422		-	m	-	-				
<u>MIME-Version</u>			o		o	o			o	o
<u>Organization</u>			-		o	-			o	o
<u>P-Access-Network-Info</u>	dr		-	-	o	-	-	o	o	
<u>P-Asserted-Identity</u>	adr		-	-	o	o	-		o	
<u>P-Associated-URI</u>	2xx		-	-	-	-	-	-	-	-
<u>P-Called-Party-ID</u>	R	a m r	-	-	o	-	-	o	o	
<u>P-Charging-Function-Addresses</u>	adr		o	o	o	o	o	o	o	
<u>P-Charging-Vector</u>	admr		o	o	o	o	o	o	o	
<u>P-DCS-Billing-Info</u>	admr			-	-	-	-	-	-	-
<u>P-DCS-LAES</u>	adr			-	-	-	-	-	-	-
<u>P-DCS-OSPS</u>	R	d r		-	o	-	-	-	-	-
<u>P-DCS-Redirect</u>	adr	-	-	-	-	-	-			
<u>P-DCS-Trace-Party-ID</u>	R	d r	-	-	-	-	-	-	-	
<u>P-Media-Authorization</u>	R	a d		o	o	-	-	-		
<u>P-Media-Authorization</u>	2xx	a d		o	o	-	-	-		
<u>Path</u>										
<u>Path</u>										
<u>P-Preferred-Identity</u>		a d r	-	-	o	o			-	o
<u>Priority</u>	R		-		o	-		-	o	
<u>Privacy</u>		a d m r	o	o	o	o	o	o		
<u>Proxy-Authenticate</u>	407		m		m	m			m	m
<u>Proxy-Authenticate</u>	401		m						o	o
<u>Proxy-Authorization</u>	R		o		o	o			o	o
<u>Proxy-Require</u>	R		o		o	o			o	o
<u>P-Visited-Network-ID</u>	R	a d	-	-	o	-	-	o	o	
<u>Rack</u>	R		m		-	-				

HEADER FIELD	WHERE	PROXY	PRA	UPD	SUB	NOT	INF	MSG	REF	PUB
<u>Reason</u>										
<u>Record-Route</u>	R		o		o	o			o	-
<u>Record-Route</u>	2xx		o		o	o			o	-
<u>Record-Route</u>	18x		o						o	-
<u>Record-Route</u>	401,484				o	o				-
<u>Refer-To</u>	R		-	-	-	-	-	-	m	-
<u>Referred-By</u>										
<u>Reject-Contact</u>	R	a r	o	o	o	o	o	o	o	
<u>Replaces</u>	R		-	-	-	-	-	-	-	
<u>Reply-To</u>			-		-	-			-	
<u>Request-Disposition</u>	R	a r	o	o	o	o	o	o	o	
<u>Require</u>			c		o	o			c	o
<u>Resource-Priority</u>	R	a m d r	o	o	o	o	o	o	o	o
<u>Retry-After</u>	404,413, 480,486		o		o	o			o	o
<u>Retry-After</u>	500,503		o		o	o			o	o
<u>Retry-After</u>	600,603		o		o	o			o	o
<u>Route</u>	R		c		m	c			c	c
<u>Rseq</u>	1xx		-		o	o				
<u>Security-Client</u>	R	a r d	-	o	o	o	o	o		
<u>Security-Server</u>	421,49		-	o	o	o	o	o		
<u>Security-Verify</u>	R	a r d	-	o	o	o	o	o		
<u>Server</u>	r		o		o	o			o	o
<u>Service-Route</u>	2xx	a r	-							
<u>Session-Expires</u>	R	a m r	-	o	-	-				
<u>Session-Expires</u>	2xx	a r	-	o	-	-				
<u>SIP-Etag</u>	2xx		-	-	-	-	-	-	-	m
<u>SIP-If-Match</u>	R		-	-	-	-	-	-	-	o
<u>Subject</u>	R		-		-	-			-	o
<u>Subscription-State</u>										
<u>Supported</u>	R		o		o	o			o	o
<u>Supported</u>	2xx		o		o	o			o	o
<u>Timestamp</u>			o		o	o			o	o
<u>To</u>	c(1)		m		m	m			m	m
<u>Unsupported</u>	420		m		o	o			o	o

HEADER FIELD	WHERE	PROXY	PRA	UPD	SUB	NOT	INF	MSG	REF	PUB
User-Agent			o		o	o			o	o
<u>Via</u>	R		m		-	o				m
<u>Via</u>		c								m
<u>Via</u>	rc	d r								m
<u>Warning</u>	r		o		o	o			o	o
<u>WWW-Authenticate</u>	401	a r	m		m	m			m	m
<u>WWW-Authenticate</u>	407	a r							o	o

[Table 4.3-3](#), IANA Registry Listing of Header Field Parameters, is a copy of the Internet Assigned Numbers Authority (IANA) Registry listing the header field parameters and parameter values (RFC 3968, Section 4.1, Header Field Parameters Sub-Registry). The underlined entries signify the header fields that MUST be supported by at least one category of an AS-SIP signaling appliance.

Table 4.3-3. IANA Registry Listing of Header Field Parameters

HEADER FIELD	PARAMETER NAME	PREDEFINED VALUES	REFERENCE
<u>Accept</u>	q	No	[RFC3261]
<u>Accept-Encoding</u>	q	No	[RFC3261]
<u>Accept-Language</u>	q	No	[RFC3261]
<u>Authorization</u>	algorithm	Yes	[RFC3261] [RFC3310]
<u>Authorization</u>	auts	No	[RFC3310]
<u>Authorization</u>	cnonce	No	[RFC3261]
<u>Authorization</u>	nc	No	[RFC3261]
<u>Authorization</u>	nonce	No	[RFC3261]
<u>Authorization</u>	opaque	No	[RFC3261]
<u>Authorization</u>	qop	Yes	[RFC3261]
<u>Authorization</u>	realm	No	[RFC3261]
<u>Authorization</u>	response	No	[RFC3261]
<u>Authorization</u>	uri	No	[RFC3261]
<u>Authorization</u>	username	No	[RFC3261]
Authentication-Info	cnonce	No	[RFC3261]
Authentication-Info	nc	No	[RFC3261]
Authentication-Info	nextnonce	No	[RFC3261]
Authentication-Info	qop	Yes	[RFC3261]
Authentication-Info	rspauth	No	[RFC3261]
Call-Info	purpose	Yes	[RFC3261]

HEADER FIELD	PARAMETER NAME	PREDEFINED VALUES	REFERENCE
<u>Contact</u>	expires	No	[RFC3261]
<u>Contact</u>	q	No	[RFC3261]
<u>Content-Disposition</u>	handling	Yes	[RFC3261]
<u>Event</u>	id	No	[RFC3265]
<u>From</u>	tag	No	[RFC3261]
P-Access-Network-Info	cgi-3gpp	No	[RFC3455]
P-Access-Network-Info	utran-cell-id-3gpp	No	[RFC3455]
P-Charging-Function-Addresses	ccf	No	[RFC3455]
P-Charging-Function-Addresses	ecf	No	[RFC3455]
P-Charging-Vector	icid-value	No	[RFC3455]
P-Charging-Vector	icid-generated-at	No	[RFC3455]
P-Charging-Vector	orig-ioi	No	[RFC3455]
P-Charging-Vector	term-ioi	No	[RFC3455]
P-DCS-Billing-Info	called	No	[RFC3603]
P-DCS-Billing-Info	calling	No	[RFC3603]
P-DCS-Billing-Info	charge	No	[RFC3603]
P-DCS-Billing-Info	locroute	No	[RFC3603]
P-DCS-Billing-Info	rksgroup	No	[RFC3603]
P-DCS-Billing-Info	routing	No	[RFC3603]
P-DCS-LAES	content	No	[RFC3603]
P-DCS-LAES	key	No	[RFC3603]
P-DCS-Redirect	count	No	[RFC3603]
P-DCS-Redirect	redirector-uri	No	[RFC3603]
<u>Proxy-Authenticate</u>	algorithm	Yes	[RFC3261] [RFC3310]
<u>Proxy-Authenticate</u>	domain	No	[RFC3261]
<u>Proxy-Authenticate</u>	nonce	No	[RFC3261]
<u>Proxy-Authenticate</u>	opaque	No	[RFC3261]
<u>Proxy-Authenticate</u>	qop	Yes	[RFC3261]
<u>Proxy-Authenticate</u>	realm	No	[RFC3261]
<u>Proxy-Authenticate</u>	stale	Yes	[RFC3261]
<u>Proxy-Authorization</u>	algorithm	Yes	[RFC3261] [RFC3310]
<u>Proxy-Authorization</u>	auts	No	[RFC3310]
<u>Proxy-Authorization</u>	cnonce	No	[RFC3261]
<u>Proxy-Authorization</u>	nc	No	[RFC3261]

HEADER FIELD	PARAMETER NAME	PREDEFINED VALUES	REFERENCE
<u>Proxy-Authorization</u>	nonce	No	[RFC3261]
<u>Proxy-Authorization</u>	opaque	No	[RFC3261]
<u>Proxy-Authorization</u>	qop	Yes	[RFC3261]
<u>Proxy-Authorization</u>	realm	No	[RFC3261]
<u>Proxy-Authorization</u>	response	No	[RFC3261]
<u>Proxy-Authorization</u>	uri	No	[RFC3261]
<u>Proxy-Authorization</u>	username	No	[RFC3261]
<u>Reason</u>	cause	Yes	[RFC3326]
<u>Reason</u>	text	No	[RFC3326]
<u>Retry-After</u>	duration	No	[RFC3261]
Security-Client	alg	Yes	[RFC3329]
Security-Client	ealg	Yes	[RFC3329]
Security-Client	d-alg	Yes	[RFC3329]
Security-Client	d-qop	Yes	[RFC3329]
Security-Client	d-ver	No	[RFC3329]
Security-Client	mod	Yes	[RFC3329]
Security-Client	port1	No	[RFC3329]
Security-Client	port2	No	[RFC3329]
Security-Client	prot	Yes	[RFC3329]
Security-Client	q	No	[RFC3329]
Security-Client	spi	No	[RFC3329]
Security-Server	alg	Yes	[RFC3329]
Security-Server	ealg	Yes	[RFC3329]
Security-Server	d-alg	Yes	[RFC3329]
Security-Server	d-qop	Yes	[RFC3329]
Security-Server	d-ver	No	[RFC3329]
Security-Server	mod	Yes	[RFC3329]
Security-Server	port1	No	[RFC3329]
Security-Server	port2	No	[RFC3329]
Security-Server	prot	Yes	[RFC3329]
Security-Server	q	No	[RFC3329]
Security-Server	spi	No	[RFC3329]
Security-Verify	alg	Yes	[RFC3329]
Security-Verify	ealg	Yes	[RFC3329]
Security-Verify	d-alg	Yes	[RFC3329]

HEADER FIELD	PARAMETER NAME	PREDEFINED VALUES	REFERENCE
Security-Verify	d-qop	Yes	[RFC3329]
Security-Verify	d-ver	No	[RFC3329]
Security-Verify	mod	Yes	[RFC3329]
Security-Verify	port1	No	[RFC3329]
Security-Verify	port2	No	[RFC3329]
Security-Verify	prot	Yes	[RFC3329]
Security-Verify	q	No	[RFC3329]
Security-Verify	spi	No	[RFC3329]
<u>Subscription-State</u>	expires	No	[RFC3265]
<u>Subscription-State</u>	reason	Yes	[RFC3265]
<u>Subscription-State</u>	retry-after	No	[RFC3265]
<u>To</u>	tag	No	[RFC3261]
<u>Via</u>	branch	No	[RFC3261]
<u>Via</u>	comp	Yes	[RFC3486]
<u>Via</u>	maddr	No	[RFC3261]
<u>Via</u>	received	No	[RFC3261]
<u>Via</u>	rport	No	[RFC3581]
<u>Via</u>	ttl	No	[RFC3261]
<u>WWW-Authenticate</u>	algorithm	Yes	[RFC3261] [RFC3310]
<u>WWW-Authenticate</u>	domain	Yes	[RFC3261]
<u>WWW-Authenticate</u>	nonce	No	[RFC3261]
<u>WWW-Authenticate</u>	opaque	No	[RFC3261]
<u>WWW-Authenticate</u>	qop	Yes	[RFC3261]
<u>WWW-Authenticate</u>	realm	No	[RFC3261]
<u>WWW-Authenticate</u>	stale	Yes	[RFC3261]

4.3.1 SC Header Requirements

SIP-000980 The SCs MUST, in adherence with the enumerated RFCs, be capable of generating, receiving, and processing the following SIP header fields: (RFC 3261, Section 20, Header Fields) (RFC 3262) (RFC 3265) (RFC 3325) (RFC 3326) (RFC 3515) (RFC 3891) (RFC 4028) (RFC 4412 as modified herein).

- Alert-Info
- Allow
- Allow-Events
- Authorization (receive only)
- Call-ID
- Contact
- Content-Disposition
- Content-Length
- Content-Type

- CSeq
- Expires
- Min-Expires
- Proxy-Authenticate (generate only)
- Rack
- Refer-To
- Resource-Priority
- Session-Expires
- To
- Warning
- Date
- From
- Min-SE
- Proxy-Authorization (receive and process only)
- Reason
- Replaces
- Retry-After
- Subscription-State
- Unsupported
- WWW-Authenticate (receive only)
- Event
- Max-Forwards
- P-Asserted-Identity
- Proxy-Require (Classified only)
- Record-Route
- Require
- RSeq
- Supported
- Via

4.3.1.1 Referred-By Header

SIP-000990 The SCs MUST be capable of receiving and processing the Referred-By header field.

SIP-000990.a The SCs that generate the REFER header MUST also generate the Referred-By header.

SIP-001000 Whenever an SC creates a request, the From header field MUST include a tag field (RFC 3261, Section 19.3, Tags).

SIP-001010 Whenever an SC creates a request that is part of a dialog, the To header field MUST include a tag field (RFC 3261, Section 19.3, Tags).

SIP-001020 The SCs MUST support the use of option tags for the Require, Supported, and Unsupported header fields. Currently, option tags used in this specification are “replaces,” “100rel,” “resource-priority,” “precondition,” and “timer.”

4.3.1.2 Route Header – SC

SIP-001030 When an SC sends an initial SIP INVITE request (i.e., the request that begins a dialog³) to its local SBC intended for its SS, then the SC MUST add two Route header field values, which either takes the form of a route set comprising two Route headers where the first Route header is the sip uri for the SBC at the enclave, and the second Route header is the sip uri

³ A dialog consists of the sequence of messages that begins with an initial SIP INVITE request and ends with either a 3xx, 4xx, 5xx, or 6xx response, or in the case of a 200 success response, the sequence of messages ends with a BYE request.

for the SBC serving the SS or takes the form of one Route header with two comma-separated field values.

NOTE: This requirement does not preclude the SC from adding Route headers to SIP requests other than the initial INVITE; however, the SC is only required to add Route headers to the initial INVITE.

SIP-001030.a The format of the sip uri of the Route headers MUST consist of an alphanumeric identifier for the userinfo part and an IP address for the host name.

Example:

Route: <sip:sbcenc1@192.168.7.125;lr>

Route: <sip:sbcSDN3@195.117.2.1;lr>

or

Route: <sip:sbcenc1@192.168.7.125;lr>, <sip:SBCSDN3@195.117.2.1;lr>

4.3.1.3 Route Header – Softswitch

SIP-001040 When an SS forwards an initial SIP INVITE request (i.e., the request that begins a dialog) to a peer SS, then the SS MUST add two Route header field values, which either may take the form of a route set comprising two Route headers where the first Route header is the sip uri for the SBC that serves the SS, and the second Route header is the sip uri for the SBC serving the peer SS, or take the form of one Route header with two comma-separated field values.

NOTE: This requirement does not preclude the SS from adding Route headers to SIP requests other than the initial INVITE; however, the SS is only required to add Route headers to the initial INVITE.

SIP-001040.a The default format of the sip uri for the Route header will consist of an alphanumeric identifier for the userinfo part and an IP address for the host name.

Example:

Route: <sip:sbcSDN3@192.168.100.100;lr>

Route: <sip:sbcSDN7@196.1.2.111;lr>

or

Route: <sip:SBCSDN3@192.168.100.100;lr>, <sip:SBCSDN7@196.1.2.111;lr>

SIP-001050 [Required: SS] When an SS forwards an initial SIP INVITE request (i.e., the request that begins a dialog) to a subtended SC, then the SS MUST add two Route header field values, which either may take the form of a route set comprising two Route headers where the first Route header is the sip uri for the SBC that serves the SS, and the second Route header is

the sip uri for the SBC serving the subtended SC, or take the form of one Route header with two comma-separated field values.

NOTE: This requirement does not preclude the SS from adding Route headers to SIP requests other than the initial INVITE; however, the SS is only required to add Route headers to the initial INVITE.

SIP-001050.a The default format of the sip uri for the Route header will consist of an alphanumeric identifier for the userinfo part and an IP address for the host name.

Example:

Route: <sip:sbcSDN7@192.168.88.50;lr>

Route: <sip:sbcenc25@188.2.44.3;lr>

or

Route: <sip:sbcSDN7@192.168.88.50;lr>, <sip:SBCenc25@188.2.44.3;lr>

4.3.1.4 Route Header – SC (Classified Network Only)

The Route header requirements for SCs and SSs are predicated on the SBU network architecture in which SBCs are required at each enclave having at least one AS-SIP signaling appliance.

The current VoSIP architecture does not use SBCs; therefore, it is anticipated that during the transition toward full implementation of AS-SIP within the classified network there will be instances where SBCs may or not be present at all locations encountered on an end-to-end AS-SIP call. Therefore, the classified requirements must include specifications for the various permutations of Route headers for the situations where an SBC is present at a Tier0 SS or at an SC, or at both. If there is not an SBC at either location and there are no intermediary AS-SIP signaling appliances between an SC and its Tier0 SS, then there may not be a need for a Route header.

The complete set of Route header requirements for SCs and Tier0 SSs in the classified network is set forth as follows:

SIP-001060 If an SBC is deployed at the enclave of an SC and an SBC is deployed at the Tier0 SS serving the given SC, then when the SC sends an initial SIP INVITE request (i.e., the request that begins a dialog) to its local SBC intended for its Tier0 SS, the SC MUST add two Route header field values, which either take the form of a route set comprising two Route headers where the first Route header is the sip uri for the SBC at the enclave, and the second Route header is the sip uri for the SBC serving the Tier0 SS, or take the form of one Route header with two comma-separated field values.

NOTE: This requirement does not preclude the SC from adding Route headers to SIP requests other than the initial INVITE; however, the SC is only required to add Route headers to the initial INVITE.

SIP-001060.a The format of the sip uri of the Route headers MUST consist of an alphanumeric identifier for the userinfo part and an IP address for the host name.

Example:

```
Route: <sip:SBCenc1@192.168.7.125;lr>  
Route: sip:SBCsdn3@195.117.2.1;lr  
or  
Route: <sip:SBCenc1@192.168.7.125;lr>, <sip:SBCsdn3@195.117.2.1;lr>
```

SIP-001070 If there is an SBC deployed at the enclave but not at the Tier0 SS, then when the SC sends an initial SIP INVITE request (i.e., the request that begins a dialog) to its local SBC intended for its Tier0 SS the SC MUST add two Route header field values, which either may take the form of a route set comprising two Route headers where the first Route header is the sip uri for the SBC at the enclave, and the second Route header is the sip uri for the Tier0 SS or take the form of one Route header with two comma-separated field values (the first having the sip uri of the SBC at the enclave and the second having the sip uri of the Tier0 SS).

NOTE: This requirement does not preclude the SC from adding Route headers to SIP requests other than the initial INVITE; however, the SC is only required to add Route headers to the initial INVITE.

SIP-001070.a The format of the sip uri of the Route headers MUST consist of an alphanumeric identifier for the userinfo part and an IP address for the host name.

Example:

```
Route: <sip:sbcenc1@192.168.7.125;lr>  
Route: <sip:Tier0sdn3@195.117.3.121;lr>  
or  
Route: <sip:sbcenc1@192.168.7.125;lr>, <sip:Tier0sdn3@195.117.3.121;lr>
```

SIP-001080 If there is not an SBC deployed at the enclave but there is an SBC deployed at the Tier0 SS, then when the SC sends an initial SIP INVITE request (i.e., the request that begins a dialog) to the SBC serving the Tier0 SS, the SC MUST either add one Route header with the sip uri of the SBC serving the Tier0 SS.

NOTE: The SBC serving the Tier0 SS always sends its inbound sip messages to the Tier0 SS) or add two Route header field values, which either may take the form of two Route headers where the first Route header is the sip uri for the SBC serving the Tier0 SS and the second Route header is the sip uri for the Tier0 SS or take the form of one Route header with two comma-separated field values (the first having the sip uri of the SBC serving the Tier) SS and the second having the sip uri of the Tier0 SS.

NOTE: This requirement does not preclude the SC from adding Route headers to SIP requests other than the initial INVITE; however, the SC is only required to add Route headers to the initial INVITE.

SIP-001080.a The format of the sip uri of the Route headers MUST consist of an alphanumeric identifier for the userinfo part and an IP address for the host name.

Example 1:

Route: <sip:SBCsdn3@195.117.2.1;lr>

Example 2:

Route: <sip:SBCsdn3@195.117.2.1;lr>

Route: <sip:Tier0sdn3@195.117.3.121;lr>

or

Route: <sip:SBCsdn3@195.117.2.1;lr>, <sip:Tier0sdn3@195.117.3.121;lr>

4.3.1.5 Route Header – Tier0 SS (Classified Network Only)

SIP-001090

NOTE: This paragraph applies to a classified network only.

If SBCs are used in conjunction with Tier0 SSs, then when a Tier0 SS forwards an initial SIP INVITE request (i.e., the request that begins a dialog) to a peer Tier0 SS, as a default configuration, the Tier0 SS MUST add two Route header field values, which either may take the form of a route set comprising two Route headers where the first Route header is the sip uri for the SBC that serves the Tier0 SS, and the second Route header is the sip uri for the SBC serving the peer Tier0 SS, or take the form of one Route header with two comma-separated field values.

NOTE: This requirement does not preclude the Tier0 SS from adding Route headers to SIP requests other than the initial INVITE; however, the Tier0 SS is only required to add Route headers to the initial INVITE.

SIP-001090.a The default format of the sip uri for the Route header will consist of an alphanumeric identifier for the userinfo part and an IP address for the host name.

Example:

Route: <sip:SBCsdn3@192.168.100.100;lr>

Route: <sip:SBCsdn7@196.1.2.111;lr>

or

Route: <sip:SBCsdn3@192.168.100.100;lr>, <sip:SBCsdn7@196.1.2.111;lr>

SIP-001100

NOTE: This paragraph applies to a classified network only.

If SBCs are used in conjunction with Tier0 SSs and at the enclaves in conjunction with SCs, then when a Tier0 SS forwards an initial SIP INVITE request (i.e., the request that begins a dialog) to a served SC, as a default configuration, the Tier0 SS **MUST** add two Route header field values, which either may take the form of a route set comprising two Route headers where the first Route header is the sip uri for the SBC that serves the Tier0 SS, and the second Route header is the sip uri for the SBC of the served SC, or take the form of one Route header with two comma-separated field values.

NOTE: This requirement does not preclude the Tier0 SS from adding Route headers to SIP requests other than the initial INVITE; however, the Tier0 SS is only required to add Route headers to the initial INVITE.

SIP-001110

NOTE: This paragraph applies to a classified network only.

If there is an SBC deployed at the Tier0 SS but not at the enclave of a served SC, then when the Tier0 SS sends an initial SIP INVITE request (i.e., the request that begins a dialog) to its local SBC intended for the served SC, the Tier0 SS **MUST** add two Route header field values, which either may take the form of a route set comprising two Route headers where the first Route header is the sip uri for its own SBC, and the second Route header is the sip uri for the SBC serving the SC, or take the form of one Route header with two comma-separated field values.

NOTE: This requirement does not preclude the Tier0 SS from adding Route headers to SIP requests other than the initial INVITE; however, the Tier0 SS is only required to add Route headers to the initial INVITE.

SIP-001120

NOTE: This paragraph applies to a classified network only.

If there is not an SBC deployed at the Tier0 SS but there is an SBC deployed at the enclave of the served SC, then when the Tier0 SS sends an initial SIP INVITE request (i.e., the request that begins a dialog) to the SBC serving the SC, the SC **MUST** either add one Route header with the sip uri of the SBC serving the SC

NOTE: The SBC serving the SC always sends its inbound sip messages to the SC.

or add two Route header field values, which either may take the form of Route headers where the first Route header is the sip uri for the SBC serving the SC, and the second Route header is the sip uri for the SC, or take the form of one Route header with two comma-separated field values.

NOTE: This requirement does not preclude the Tier0 SS from adding Route headers to SIP requests other than the initial INVITE; however, the Tier0 SS is only required to add Route headers to the initial INVITE.

4.3.1.6 “CCA-ID” Parameter for Contact Header

The purpose behind the CCA-ID is to provide a simple mechanism for an SS to identify the served SC that is the source of the INVITE. This is important information required to enable the SS to conduct its Policing function. The CCA-ID also provides a simple mechanism for a destination SS to identify the originating SS from which it receives an INVITE.

SIP-001130 When an SC either receives an INVITE from a served AS-SIP EI or a SIP EI or generates an INVITE on behalf of a served H.323 or vendor proprietary IP EI and the INVITE is intended for a destination over the UC WAN, then the SC MUST add a “CCA-ID” parameter to the SIP URI of the Contact header. The value of the “CCA-ID” parameter consists of a variable length character string having a maximum length of 20 characters from the set specified in Requirement SIP-001130.a and a unique value of the “CCA-ID” parameter is associated with each SC (and each SS).

SIP-001130.a The syntax for the “CCA-ID” parameter is:

CCA-ID = token = 1*(alphanumeric/ "-" / ".")

Example:

Contact: <sip:3121111111@10.10.10.10;user=phone;CCA-ID= SCA.scottafb >

SIP-001140 When an SC receives an inbound INVITE from the UC WAN intended for a served AS-SIP EI or SIP EI, the SC MUST strip off the “CCA-ID” parameter.

SIP-001140.a When an intermediary SS either receives an INVITE from a served SC or from another SS, then the intermediary SS MUST replace the existing value of the “CCA-ID” parameter with the value of its own “CCA-ID” parameter, before forwarding the INVITE onward to the next AS-SIP signaling appliance.

SIP-001150 In the event an SS receives an INVITE that either does not include the “CCA-ID” parameter in the Contact header of the INVITE or includes a “CCA-ID” parameter in the Contact header of the INVITE that has an unknown value, then the SS MUST reject the INVITE by sending a 400 (Bad Request) response that includes the Warning header and a newly defined warning code, 390:

390 Bad CCA-ID parameter: CCA-ID parameter is either missing or its value is unknown.

NOTE: Since this failure condition is relevant to the UC network and is outside the scope of user knowledge and control, the warn-text field for this warning code is deliberately left blank.

The SS MUST send an alarm to the NMS. The alarm MUST notify the NMS that the SS received an INVITE that did not include a valid “CCA-ID” parameter.

SIP-001150.a When an SC receives a 400 (Bad Request) with a Warning header with a warning code 390 (Bad CCA-ID parameter) from the SS in response to an outbound INVITE from a served non-AS-SIP IP EI, then the SC MUST:

- Respond to the 400 (Bad Request) response from the SS with an ACK.
- Terminate the call request with the non-AS-SIP IP EI by playing the reorder tone until the caller goes on-hook.
- Send an alarm to the NMS to alert the NMS that the SC has received a 400 (Bad Request) with a Warning header with a warning code 390 (Bad CCA-ID parameter) in response to an outbound INVITE.

SIP-001150.b When an SC receives a 400 (Bad Request) with a warning code 390 (Bad CCA-ID parameter) from the SS in response to an outbound INVITE from a served AS-SIP EI, then the SC MUST:

- Respond to the 400 (Bad Request) response from the SS with an ACK.
- Strip off the Warning header and forward the 400 (Bad Request) response to the AS-SIP EI.⁴

NOTE: The AS-SIP EI will play the reorder tone until the caller goes on-hook and responds with an ACK and terminates the call request.

- Send an alarm to the NMS to alert the NMS that the SC has received a 400 (Bad Request) with a Warning header with a warning code 390 (Bad CCA-ID parameter) in response to an outbound INVITE.

4.3.1.7 Via Header – Rules for SIP Proxy

SIP-001160 When an SC implemented as a SIP proxy server receives an outbound AS-SIP request from a served AS-SIP EI or an outbound SIP request from a served SIP EI, then the SC MUST add its own Via header.

SIP-001170 When an SC implemented as a SIP proxy server receives an inbound AS-SIP request for a served AS-SIP EI or SIP EI, then the SC MUST add its own Via header.

SIP-001180 When an SC implemented as a SIP proxy server receives an AS-SIP response from a served AS-SIP EI or a SIP response from a served SIP EI, then before forwarding an AS-SIP response, the SC MUST remove the topmost Via header.

⁴ If the SC fails to strip off the Warning header then the desired behavior is for the AS-SIP EI to ignore the 390 warn-code and the warn-text because the CCA-ID is outside the scope of the AS-SIP EI and the user.

SIP-001190 When an SC implemented as a SIP proxy server receives an AS-SIP response intended for a served AS-SIP EI or SIP EI, then before forwarding the AS-SIP response the SC **MUST** remove the topmost Via header.

SIP-001200 When an SS implemented as a SIP proxy server receives an AS-SIP request from an SC or another SS, then the SS **MUST** add its own Via header.

SIP-001210 When an SS implemented as a SIP proxy server receives an AS-SIP response, then before forwarding the AS-SIP response the SS **MUST** remove the topmost Via header.

4.3.1.8 Via Header – Rules for B2BUA

SIP-001220 When an SC implemented as a B2BUA receives an outbound AS-SIP request from a served AS-SIP EI or an outbound SIP request from a served SIP EI, then the SC does **NOT** copy the Via header from the incoming call leg to the outgoing call leg; however, this specification does not forbid the B2BUA from copying the Via header. The SC **MUST** add its own Via header to the new call leg.

SIP-001230 When an SC implemented as a B2BUA receives an inbound AS-SIP request intended for a served AS-SIP EI or SIP EI, then the SC does **NOT** copy the Via headers from the incoming call leg to the outgoing call leg; however, this specification does not forbid the B2BUA from copying the Via headers. The SC **MUST** add its Via header to the new call leg.

SIP-001240 When an SC implemented as a B2BUA receives an AS-SIP response from a served AS-SIP EI or SIP response from a SIP EI, then the B2BUA removes the topmost header. Then the B2BUA generates the response for the call leg in which it is acting as a UAS and **MUST** place the set of Via headers it had received in the original SIP request into the SIP response.

SIP-001250 When an SC implemented as a B2BUA receives an AS-SIP response intended for a served AS-SIP EI or SIP EI, then the B2BUA removes the topmost Via header. Then the B2BUA generates the response for the call leg in which it is acting as a UAS and **MUST** place the set of Via headers it had received in the original AS-SIP request (or SIP request) into the AS-SIP (or SIP) response. If there are no intervening subtended SCs between the B2BUA and the served AS-SIP EI or SIP EI, then the only Via header placed into the response is that of the served AS-SIP EI or SIP EI.

SIP-001260 When an SS implemented as a B2BUA receives an AS-SIP request, then the SS generally does **NOT** copy the Via header(s) from the incoming call leg to the outgoing call leg; however, this specification does not forbid the B2BUA from copying the Via headers. The SS **MUST** add its own Via header to the new call leg.

SIP-001270 When an SS implemented as a B2BUA receives an AS-SIP response, then the B2BUA removes the topmost header. Then the B2BUA generates the response for the call leg in which it is acting as a UAS and **MUST** place the set of Via headers it had received in the original SIP request into the SIP response.

4.3.1.9 Via Header – Rules for SC Acting as UAC/UAS on Behalf of the IP EI

SIP-001280 When an SC generates an outbound AS-SIP request on behalf of a served H.323 or vendor-proprietary IP EI, then the SC MUST add its own Via header to the AS-SIP request.

SIP-001290 When an SC receives an inbound AS-SIP request intended for a served H.323 or vendor-proprietary IP EI, then the SC operates as the UAS for SIP purposes and sends the appropriate protocol request to the H.323 or vendor-proprietary IP EI.

SIP-001300 When an SC generates an AS-SIP response on behalf of a served H.323 or vendor-proprietary IP EI, then the SC MUST include the Via headers received in the corresponding AS-SIP request before forwarding the AS-SIP response.

SIP-001310 When an SC receives an AS-SIP response intended for a served H.323 or vendor-proprietary IP EI, then the SC operates as the UAC for SIP purposes and sends the appropriate protocol response to the H.323 or vendor-proprietary IP EI.

4.3.1.10 Via Header – Rules for AS-SIP EI

SIP-001320 When an AS-SIP EI generates an outbound AS-SIP request, the AS-SIP EI MUST add its own Via header to the AS-SIP request.

SIP-001330 When an AS-SIP EI generates an AS-SIP response, the AS-SIP EI MUST include the Via headers received in the corresponding AS-SIP request before forwarding the AS-SIP response.

4.3.2 AS-SIP EI Header Requirements

SIP-001340 The AS-SIP EIs MUST be, in adherence with the enumerated RFCs, capable of generating, receiving, and processing the following SIP header fields: (RFC 3261, Section 20, Header Fields) (RFC 3262) (RFC 3265) (RFC 3326) (RFC 3515) (RFC 3891) (RFC 4028) (RFC 4412 as modified herein).

- Accept
- Allow-Events
- Contact
- Content-Type
- Event
- Max-Forwards
- P-Asserted-Identity (receive only)
- Alert-Info
- Authorization (generate and send only)
- Content-Disposition
- CSeq
- Expires
- Min-Expires
- Proxy-Authenticate (receive only)
- Allow
- Call-ID
- Content-Length
- Date
- From
- Min-SE
- Proxy-Authorization (generate and send only)

- Proxy-Require (generate for Classified network only)
- Record-Route
- Require
- RSeq
- Supported
- Via
- Rack
- Refer-To
- Resource-Priority ([AS-SIP EI with P&P](#))
- Session-Expires
- To
- Warning
- Reason
- Replaces
- Retry-After
- Subscription-State
- Unsupported
- WWW-Authenticate (generate and send only)

4.3.2.1 Referred-By Header

SIP-001350 The AS-SIP EIs MUST be capable of receiving and processing the Referred-By header field (RFC 3892).

SIP-001360 The AS-SIP EIs that generate the REFER request MUST also generate the Referred-By header.

4.3.2.2 Tags

SIP-001370 Whenever an AS-SIP EI creates a request, the From header field MUST include a tag field (RFC 3261, Section 19.3, Tags.)

SIP-001380 Whenever an AS-SIP EI creates a request that is part of a dialog, the To header field MUST include a tag field (RFC 3261, Section 19.3, Tags).

SIP-001390 The AS-SIP EIs MUST support the use of option tags for the Require, Supported, and Unsupported header fields. Currently, option tags used in this specification are “replaces,” “100rel,” “resource-priority,” “precondition,” and “timer.”

4.4 SIP RESPONSE CODES

4.4.1 SCs Serving AS-SIP EIs

SIP-001400 The SCs serving AS-SIP EIs MUST support response processing (RFC 3261, Section 16.7, Response Processing).

SIP-001410 The SCs serving AS-SIP EIs MUST support the forwarding of the provisional (1xx) response codes: 100 (Trying), 180 (Ringing), and 183 (Session Progress). (RFC 3261, Section 16.7, Response Processing).

SIP-001420 The SCs serving AS-SIP EIs MUST support generating a 100 (Trying) response code.

SIP-001430 The SCs serving AS-SIP EIs **MUST** support the forwarding of the successful (2xx) response codes: 200 (OK) (RFC 3261) and (202) Accepted (RFC 3515).

SIP-001440 The SCs serving AS-SIP EIs **MUST** support the generating of a 200 (OK) response code in response to a CANCEL request. (RFC 3261, Section 16.10, CANCEL Processing).

SIP-001450 The SCs serving AS-SIP EIs **MAY** be capable of operating as redirect servers and **MAY** support the redirection (3xx) response codes: 300 (Multiple Choices), 301 (Moved Permanently), 302 (Moved Temporarily), and 305 (Use Proxy). (RFC 3261, Section 21.3, Redirection 3xx).

SIP-001460 The SCs serving AS-SIP EIs **MUST** support the forwarding of the following request failure (4xx) response codes:

- 400 (Bad Request)
- 401 (Unauthorized)
- 403 (Forbidden)
- 404 (Not Found)
- 405 (Method Not Allowed)
- 406 (Not Acceptable)
- 407 (Proxy Authentication Required)
- 408 (Request Timeout)
- 410 (Gone)
- 413 (Request Entity Too Large)
- 414 (Request-URI Too Long)
- 415 (Unsupported Media Type)
- 416 (Unsupported URI Scheme)
- 417 (Unknown Resource-Priority)
- 420 (Bad Extension)
- 421 (Extension Required)
- 422 (Session Interval Too Small)
- 423 (Interval Too Brief)
- 480 (Temporarily Unavailable)
- 481 (Call/Transaction Does Not Exist)
- 482 (Loop Detected)
- 483 (Too Many Hops)
- 484 (Address Incomplete)
- 485 (Ambiguous)
- 486 (Busy Here)
- 487 (Request Terminated)
- 488 (Not Acceptable Here)
- 491 (Request Pending)

NOTE: In those instances in which 4xx messages trigger the playing of announcements at the AS-SIP EI (e.g., Blocked Precedence Announcement [BPA], Busy Not Equipped Announcement [BNEA], ICA, VCA), appropriate interoperable signaling is defined between the SC/media server and the AS-SIP EI to manage the streaming of the announcement from the media server to the AS-SIP EI followed by the forwarding of the 4xx message to the AS-SIP EI. The AS-SIP EI responds with an ACK that terminates the call request.

SIP-001470 An SC serving AS-SIP EIs **MAY** support the generating of a 401 (Unauthorized) response in connection with the receipt of a Register request from an AS-SIP EI for which the

Registrar has no current bindings or even when the AS-SIP EI is renewing, adding, or removing bindings.

SIP-001480 An SC serving AS-SIP EIs **MUST** support the generating of a 403 (Forbidden) response.

SIP-001490 An SC serving AS-SIP EIs **MUST** support the generating of a 404 (Not Found) response code if the Request-URI of an inbound request from the UC WAN identifies a DSN number that is unknown to the SC. The 404 (Not Found) response is sent back toward the originating SC. [RFC 3261, Section 16.5, Determining Request Targets]

SIP-001500 An SC serving AS-SIP EIs **MUST** support the generating of a 405 (Method Not Allowed) response code. One example where generation of this code is applicable is upon receipt of an INVITE that includes an encapsulated ISUP message.

SIP-001510 [Optional] The SCs serving AS-SIP EIs **MAY** support the generating of a 407 (Proxy Authentication Required) response code (RFC 3261, Section 22.3, Proxy-to-User Authentication).

SIP-001520 The SCs serving AS-SIP EIs **MUST** support the generating of a 408 (Request Timeout) response code when all client transactions in a response have terminated and no final response has been received (RFC 3261, Section 16.6, Request Forwarding).

SIP-001530 An SC serving AS-SIP EIs **MUST** support the generating of a 415 (Unsupported Media Type) response code. One example where generation of this code is applicable is upon receipt of an INVITE that includes an encapsulated ISUP message.

SIP-001540 The SCs serving AS-SIP EIs **MUST** support the generating of a 416 (Unsupported URI Scheme) response code upon receipt of a Request-URI that it does not understand (RFC 3261, Section 16.3, Request Validation).

SIP-001550 The SCs serving AS-SIP EIs **MUST** support the generating of a 417 (Unsupported Resource-Priority) response code upon receipt of an INVITE with a Resource-Priority header intended for a served AS-SIP EI and the INVITE has a Require header field with an option tag “resource-priority.”

SIP-001560 [Requirement] This paragraph applies to a classified network only. The SCs **MUST** support the generating of a 418 (Incompatible CAL) response code upon receipt of an INVITE that cannot be resolved to a valid Confidentiality Access Level (CAL). The 418 response **SHOULD** contain the CAL header with the reflected-access-level set to the last successfully resolved value in the request path. The local-access-level **SHOULD** be set to the access-level supported by the destination UAS or to the access-level supported for the routing domain that failed resolution at an intermediate Tier0 SS.

SIP-001570 The SCs serving AS-SIP EIs **MUST** support the generating of a 420 (Bad Extension) response upon receipt of a Proxy-Require header having an unrecognized option tag.

SIP-001580 The SCs serving AS-SIP EIs **MUST** support the generating of a 422 (Session Interval Too Small) response if the Session-Expires interval is lower than the value of Min-SE that the SC would wish to assert.

SIP-001590 The Registrar component of the SCs serving AS-SIP EIs **MUST** support the generating of a 423 (Interval Too Brief) response if the requested expiration value in the Register request is greater than 0, but less than 3600 (i.e., 1 hour) and less than the minimum interval configured at the Registrar.

SIP-001600 The SCs serving AS-SIP EIs **MUST** support the generating of a 481 (Call/Transaction Does Not Exist) response.

SIP-001610 The SCs serving AS-SIP EIs **MAY** generate a 482 (Loop Detected) response code if a forwarding loop is detected (RFC 3261, Section 16.3, Request Validation).

SIP-001620 The SCs serving AS-SIP EIs **MUST** support the generating of a 483 (Too Many Hops) response code upon receiving a request (other than an OPTIONS request) in which the Max-Forwards header field has a value of zero (RFC 3261, Section 16.3, Request Validation).

NOTE: If the method is OPTIONS, then the 483 (Too Many Hops) response code is not sent, instead the requirement in RFC 3261 applies (RFC 3261, Section 11, Querying for Capabilities).

SIP-001630 The SCs serving AS-SIP EIs **SHOULD** support the generating of a 485 (Ambiguous) response code if the Request-URI does not provide sufficient information for the SC to determine the target set (RFC 3261, Section 16.5, Determining Request Targets).

SIP-001640 The SCs serving AS-SIP EIs **MUST** support the generating of a 487 (Request Terminated) response code.

SIP-001650 The SCs serving AS-SIP EIs **MUST** support the generating of a 488 (Not Acceptable Here) response code.

SIP-001660 The SCs serving AS-SIP EIs **MUST** support the forwarding of the server failure (5xx) response codes:

- 500 (Server Internal Error)
- 501 (Not Implemented)
- 502 (Bad Gateway)
- 503 (Service Unavailable)
- 504 (Server Timeout)
- 505 (Version Not Supported)
- 513 (Message Too Large) (RFC 3261)

SIP-001670 If an SC serving AS-SIP EIs implements preconditions, then the SC **MUST** support generating and receiving or processing a 580 (Precondition Failure) response code.

SIP-001680 The SCs serving AS-SIP EIs MUST support the forwarding of the global failures (6xx) response codes: 600 (Busy Everywhere), 603 (Decline), 604 (Does Not Exist Anywhere), and 606 (Not Acceptable).

4.4.2 AS-SIP EIs

SIP-001690 The AS-SIP EIs MUST support sending, receiving, and processing the provisional (1xx) response codes: 100 (Trying), 180 (Ringing), and 183 (Session Progress) (RFC 3261, Section 21.1, Provisional 1xx).

SIP-001700 The AS-SIP EIs MUST support sending, receiving, and processing the successful (2xx) response code: 200 (OK) (RFC 3261, Section 21.2, 200 OK, and 202 [Accepted]) (RFC 3515).

SIP-001710 The AS-SIP EIs MAY be capable of operating as redirect servers and MAY support the following redirection (3xx) response codes: 300 (Multiple Choices), 301 (Moved Permanently), 302 (Moved Temporarily), and 305 (Use Proxy) (RFC 3261, Section 21.3, Redirection 3xxx).

SIP-001720 The AS-SIP EIs MUST support generating and receiving or processing the following request failure (4xx) response codes:

- 400 (Bad Request)
- 401 (Unauthorized) – receive only
- 403 (Forbidden)
- 404 (Not Found)
- 405 (Method Not Allowed)
- 406 (Not Acceptable)
- 407 (Proxy Authentication Required) – receive only
- 408 (Request Timeout)
- 410 (Gone)
- 413 (Request Entity Too Large)
- 414 (Request-URI Too Long)
- 415 (Unsupported Media Type)
- 416 (Unsupported URI Scheme)
- 417 (Unknown Resource-Priority)
- 420 (Bad Extension)
- 421 (Extension Required)
- 422 (Session Interval Too Small)
- 423 (Interval Too Brief) – receive only
- 480 (Temporarily Unavailable)
- 481 (Call/Transaction Does Not Exist)
- 482 (Loop Detected) – receive only
- 483 (Too Many Hops)
- 484 (Address Incomplete) – receive only
- 485 (Ambiguous) – receive only
- 486 (Busy Here)
- 487 (Request Terminated)
- 488 (Not Acceptable Here) – receive only
- 491 (Request Pending)

(RFC 3261, Section 21.4, Request Failure 4xx.)

SIP-001730 The AS-SIP EIs upon properly receiving a CANCEL for an INVITE MUST first send a 200 (OK) response code to the CANCEL, and then follow up with a 487 (Request Terminated) response code to the INVITE.

SIP-001740 The AS-SIP EIs MUST support the server failure (5xx) response codes:

- 500 (Server Internal Error)
- 501 (Not Implemented)
- 502 (Bad Gateway) – receive only
- 503 (Service Unavailable)
- 504 (Server Timeout)
- 505 (Version Not Supported)
- 513 (Message Too Large)

(RFC 3261, Section 21.5, Server Failure 5xx).

SIP-001750 If an AS-SIP EI implements preconditions, then the AS-SIP EI MUST support generating and receiving a 580 (Precondition Failure) response code.

SIP-001760 The AS-SIP EIs MUST support generating and receiving or processing the global failures (6xx) response codes: 600 (Busy Everywhere), 603 (Decline), 604 (Does Not Exist Anywhere), 606 (Not Acceptable) (RFC 3261, Section 21.6, Global Failures 6xx).

4.4.3 SCs Serving SIP EIs

SIP-001770 [Optional] The SCs serving SIP EIs MAY support response processing (RFC 3261, Section 16.7, Response Processing).

SIP-001780 The SCs serving SIP EIs MUST support the forwarding of the provisional (1xx) response codes: 100 (Trying), 180 (Ringing), and 183 (Session Progress) (RFC 3261, Section 16.7, Response Processing).

SIP-001790 The SCs serving SIP EIs MUST support the generating and forwarding of the successful (2xx) response code: 200 (OK) (RFC3261) and 202 (Accepted) (RFC 3515).

SIP-001800 The SCs serving SIP EIs MAY be capable of operating as redirect servers and MAY support the redirection (3xx) response codes: 300 (Multiple Choices), 301 (Moved Permanently), 302 (Moved Temporarily), and 305 (Use Proxy) (RFC 3261, Section 21.3, Redirection 3xx).

SIP-001810 The SCs serving SIP EIs MUST support the forwarding of the request failure (4xx) response codes:

- 400 (Bad Request)
- 401 (Unauthorized)
- 420 (Bad Extension)
- 421 (Extension Required)

- 403 (Forbidden)
- 404 (Not Found)
- 405 (Method Not Allowed)
- 406 (Not Acceptable)
- 407 (Proxy Authentication Required)
- 408 (Request Timeout)
- 410 (Gone)
- 413 (Request Entity Too Large)
- 414 (Request-URI Too Long)
- 415 (Unsupported Media Type)
- 416 (Unsupported URI Scheme)
- 417 (Unknown Resource-Priority)
- 422 (Session Interval Too Small)
- 423 (Interval Too Brief) – receive only
- 480 (Temporarily Unavailable)
- 481 (Call/Transaction Does Not Exist)
- 482 (Loop Detected) – receive only
- 483 (Too Many Hops)
- 484 (Address Incomplete)
- 485 (Ambiguous)
- 486 (Busy Here)
- 487 (Request Terminated)
- 488 (Not Acceptable Here)
- 491 (Request Pending)

SIP-001820 An SC serving AS-SIP EIs MUST support the generating of a 403 (Forbidden) response code.

SIP-001830 The SCs serving SIP EIs MUST support the generating of a 404 (Not Found) response code if the Request-URI indicates a resource at the SCs that does not exist (RFC 3261, Section 16.5, Determining Request Targets).

SIP-001840 [Optional] The SCs serving SIP EIs MAY support the generating of either a 401 (Unauthorized) or a 407 (Proxy Authentication Required) response code, as appropriate (RFC 3261, Section 22.2 User-to-User Authentication, Section 22.3, Proxy-to-User Authentication).

SIP-001850 An SC serving SIP EIs MUST support the generating of a 405 (Method Not Allowed) response code. One example where generation of this code is applicable is upon receipt of an INVITE that includes an encapsulated ISUP message.

SIP-001860 The SCs serving SIP EIs MUST support the generating of a 408 (Request Timeout) response code when all client transactions in a response have terminated and no final response has been received (RFC 3261, Section 16.6, Request Forwarding).

SIP-001870 An SC serving SIP EIs MUST support the generating of a 415 (Unsupported Media Type) response code. One example where generation of this code is applicable is upon receipt of an INVITE that includes an encapsulated ISUP message.

SIP-001880 The SCs serving SIP EIs MUST support the generating of a 416 (Unsupported URI Scheme) response code upon receipt of a Request-URI that it does not understand (RFC 3261, Section 16.3, Request Validation).

SIP-001890 The SCs serving AS-SIP EIs **MUST** support the generating of a 417 (Unsupported Resource-Priority) response code upon receipt of an INVITE with a Resource-Priority header intended for a served AS-SIP EI and the INVITE has a Require header field with an option tag “resource-priority.”

SIP-001900

(NOTE: This paragraph applies to a classified network only.)

The SCs **MUST** support the generating of a 418 (Incompatible CAL) response code upon receipt of an INVITE or UPDATE that cannot be resolved to a valid CAL. The 418 response **SHOULD** contain the CAL header with the reflected-access-level set to the last successfully resolved value in the request path. The local-access-level **SHOULD** be set to the access-level supported by the destination UAC or to the access-level supported for the routing domain that failed resolution at an intermediate Tier0 SS.

SIP-001910 The SCs serving SIP EIs **MUST** support the generating of a 420 (Bad Extension) response code upon receipt of a Proxy-Require header having an unrecognized option tag.

SIP-001920 The SCs serving SIP EIs **MUST** support the generating of a 422 (Session Interval Too Small) response code if the Session-Expires interval is lower than the value of Min-SE that the SC would wish to assert.

SIP-001930 The registrar component of the SCs serving SIP EIs **MUST** support the generating of a 423 (Interval Too Brief) response code if the requested expiration value in the Register request is greater than 0, but less than 3600 (i.e., 1 hour) and less than the minimum interval configured at the Registrar.

SIP-001940 The SCs serving SIP EIs that are unable to establish a target for a received request **SHOULD** support generating a 480 (Temporarily Unavailable) response code (RFC 3261, Section 16.5, Determining Request Targets).

NOTE: If the SC serves a nonpreemptable SIP EI, then the SC **MUST** support the generating of a 480 (Temporarily Unavailable) response code.

SIP-001950 The SCs serving SIP EIs **MUST** support the generating of a 481 (Call/Transaction Does Not Exist) response code.

SIP-001960 The SCs serving SIP EIs **MAY** generate a 482 (Loop Detected) response code if a forwarding loop is detected (RFC 3261, Section 16.3, Request Validation).

SIP-001970 The SCs serving SIP EIs **MUST** support the generating of a 483 (Too Many Hops) response code upon receiving a request (other than an OPTIONS request) in which the Max-Forwards header field has a value of zero (RFC 3261, Section 16.3, Request Validation).

NOTE: If the method is OPTIONS, then the 483 (Too Many Hops) response code is not sent, instead the requirement in RFC 3261 applies (RFC 3261, Section 11, Querying for Capabilities).

SIP-001980 The SCs serving SIP EIs SHOULD support the generating of a 485 (Ambiguous) response code if a forwarding loop is detected (RFC 3261, Section 16.3, Request Validation).

SIP-001990 The SCs serving SIP EIs MUST support the generating of a 487 (Request Terminated) response code.

SIP-002000 The SCs serving SIP EIs MUST support the generating of a 488 (Not Acceptable Here) response code.

SIP-002010 The SCs serving SIP EIs MUST support the forwarding of the server failure (5xx) response codes:

- 500 (Server Internal Error)
- 501 (Not Implemented)
- 502 (Bad Gateway) – receive only
- 503 (Service Unavailable)
- 504 (Server Timeout)
- 505 (Version Not Supported)
- 513 (Message Too Large)

(RFC 3261)

SIP-002020 If an SC serving SIP EIs implements preconditions, then the SC MUST support generating and receiving/processing a 580 (Precondition Failure) response code.

SIP-002030 The SCs serving SIP EIs SHOULD generate and send upstream a 500 (Server Internal Error) response code when the only response received to a request is a 503 (Service Unavailable) response code (RFC 3261, Section 16.7, Response Processing).

SIP-002040 The SCs serving SIP EIs MUST support forwarding of the global failures (6xx) response codes: 600 (Busy Everywhere), 603 (Decline), 604 (Does Not Exist Anywhere), 606 (Not Acceptable).

4.4.4 SCs Serving H.323 and/or Proprietary IP EIs

SIP-002050 The SCs serving H.323 and/or proprietary IP EIs MUST support generating, receiving, and processing the provisional (1xx) response codes: 100 (Trying), 180 (Ringing), and 183 (Session Progress) (RFC 3261, Section 21.1, Provisional 1xx)

SIP-002060 The SCs serving H.323 and/or proprietary IP EIs MUST support generating and receiving/processing the successful (2xx) response codes: 200 (OK) (RFC3261) and 202 (Accepted) (RFC 3515).

SIP-002070 The SCs serving H.323 and/or proprietary IP EIs MAY be capable of operating as redirect servers and MAY support the following redirection (3xx) response codes: 300 (Multiple Choices), 301 (Moved Permanently), 302 (Moved Temporarily), and 305 (Use Proxy) (RFC 3261, Section 21.3, Redirection 3xx).

SIP-002080 The SCs serving H.323 and/or proprietary IP EIs MUST support generating, receiving, and processing the following request failure (4xx) response codes:

- 400 (Bad Request)
- 401 (Unauthorized)
- 403 (Forbidden)
- 404 (Not Found)
- 405 (Method Not Allowed)
- 406 (Not Acceptable)
- 408 (Request Timeout)
- 410 (Gone)
- 413 (Request Entity Too Large)
- 414 (Request-URI Too Long)
- 415 (Unsupported Media Type)
- 416 (Unsupported URI Scheme)
- 420 (Bad Extension)
- 417 (Unknown Resource-Priority)
- 421 (Extension Required)
- 422 (Session Interval Too Small)
- 423 (Interval Too Brief) – receive only
- 480 (Temporarily Unavailable)
- 481 (Call/Transaction Does Not Exist)
- 482 (Loop Detected) – receive only
- 483 (Too Many Hops)
- 484 (Address Incomplete)
- 485 (Ambiguous)
- 486 (Busy Here)
- 487 (Request Terminated)
- 488 (Not Acceptable Here)
- 491 (Request Pending)

[RFC 3261, Section 21.4, Request Failure 4xx]

SIP-002090 The SCs serving H.323 and/or proprietary IP EIs upon properly receiving a CANCEL from an INVITE MUST first send a 200 (OK) response code to the CANCEL, and then follow up with a 487 (Request Terminated) to the INVITE.

SIP-002100 The SCs serving H.323 and/or proprietary IP EIs MUST support the generating and receiving/processing the server failure (5xx) response codes:

- 500 (Server Internal Error)
- 501 (Not Implemented)
- 502 (Bad Gateway)
- 503 (Service Unavailable)
- 504 (Server Timeout)
- 505 (Version Not Supported)
- 513 (Message Too Large)

(RFC 3261)

SIP-002110 If an SC serving H.323 and/or proprietary IP EIs implements preconditions, then the SC MUST support generating and receiving/processing a 580 (Precondition Failure) response code.

SIP-002120 The SCs serving H.323 and/or proprietary IP EIs MUST support the generating and receiving/processing of global failures (6xx) response codes: 600 (Busy Everywhere), 603 (Decline), 604 (Does Not Exist Anywhere), 606 (Not Acceptable) (RFC 3261, Section 21.6, Global Failures 6xx).

4.5 PRECONDITION

4.5.1 SBU Network

The implementation of preconditions in the SBU network is conditional.

SIP-002130 [**Conditional**] When an AS-SIP signaling appliance supports preconditions, the implementation must be IAW RFC 3312 unless a contrary requirement is located in this section (i.e., in [Section 4.5](#)) in which case the UCR requirement supersedes RFC 3312.

SIP-002140 [**Conditional**] When an AS-SIP signaling appliance supports preconditions, the activation of preconditions MUST be configurable so that the administrator of the device may enable or disable preconditions without removing the AS-SIP signaling appliance from service or losing state on existing calls or call requests.

SIP-002150 [**Conditional**] When an AS-SIP signaling appliance supports preconditions, the only required precondition-type is “qos.”

SIP-002160 [**Conditional**] When an AS-SIP signaling appliance supports preconditions, the end-to-end status type or the segmented status type MUST be supported.

NOTE: An AS-SIP signaling appliance is not precluded from supporting both the end-to-end status type and the segmented status type.

SIP-002170 [**Conditional**] When an AS-SIP signaling appliance supports preconditions, the strength-tag MUST be set to “optional” or “none.”

SIP-002180 [**Conditional**] When an AS-SIP signaling appliance initiates an offer including one or more preconditions (and noting the strength-tag must be set to “optional”), then the INVITE MUST include the option tag “precondition” in either a Supported header field or a Require header field. It is RECOMMENDED, however, that the Supported header field be used in this case. The lack of preconditions in the answer would indicate that the answerer did not support this extension (RFC 3312, Integration of Resource Management and SIP, Section 11, October 2002).

SIP-002190 When an AS-SIP signaling appliance that does not support preconditions receives an offer including one or more preconditions and a Require header field with the option tag

“precondition,” then the AS-SIP signaling appliance MUST respond with a 420 (Bad Extension) response code having an Unsupported header with the option tag “precondition.”

SIP-002200 [Conditional] If an AS-SIP signaling appliance sends an sdp offer with preconditions and receives a 420 (Bad Extension) response code having a Supported header with the option tag “precondition,” then the default behavior for the AS-SIP signaling appliance is to retry the request and omit the precondition.

SIP-002210 [Conditional] If an AS-SIP signaling appliance that sends an sdp offer with preconditions (where the “precondition” tag is placed in the Supported header NOT the Require header) receives one of the following:

- A 180 (Ringing) response does not include an sdp answer.
- (In the case of segmented preconditions) a 183 (Session Progress) response that does not include an sdp answer followed by a 180 (Ringing) response that does not include an sdp answer.
- A 18x with an sdp answer having no precondition attributes.

The AS-SIP signaling appliance MUST proceed with the standard call establishment procedure.

NOTE: For the SBU network, all strength-tags in the sdp offer MUST have the value “optional” or “none.”

SIP-002220 [Conditional] If the sdp offer with preconditions (where the “precondition” tag is placed in the Supported header NOT the Require header) is sent by the terminating AS-SIP signaling appliance in response to a received INVITE (without SDP) and the SDP answer in the PRACK does NOT include precondition attributes then the call establishment MUST proceed as usual.

SIP-002230 [Conditional] If AS-SIP signaling appliances serving IP EIs implement RFC 3312 for a call request, each local and remote AS-SIP signaling appliance MAY use its own quality-of-service mechanism, including, but not limited to, RSVP and call counting.

SIP-002240 If the preconditions are implemented, then the implementation MUST be consistent with assured service precedence and preemption rules. In particular, when preconditions are applied to a precedence call request (i.e., priority or higher) and the preconditions cannot be met, except for the preemption of one or more lesser precedence calls and/or call requests, then the lesser precedence call(s) and/or call requests MUST be preempted.

NOTE: Please see [Section 6](#), Precedence and Preemption, for details on the precedence and preemption requirements.

An example of the AS-SIP end to end status type precondition call flow is found at Requirement SIP-006140 and an example of the AS-SIP segmented status type precondition call flow is found at Requirement SIP-006150.

4.5.2 Classified Network

SIP-002250 Implementation of preconditions is conditional for the classified network (RFC 3312).

SIP-002250.a [Conditional] The AS-SIP signaling appliances MUST be configurable so the administrator of the device may enable or disable preconditions without removing the AS-SIP signaling appliance from service or losing state on existing calls or call requests.

SIP-002260 [Conditional] If preconditions are implemented and enabled, then, at this time, the only required precondition-type is “qos.”

SIP-002270 [Conditional] If preconditions are implemented, then the end-to-end status-type MUST be supported.

SIP-002280 [Conditional] If preconditions are implemented, then the AS-SIP signaling appliances MUST use the RSVP as the network resource reservation mechanism.

SIP-002290 [Conditional] When an AS-SIP signaling appliance initiates an offer including one or more preconditions (strength-tag(s) are all either “optional” or “none”), then the INVITE MUST include the option tag “precondition” in either a Supported header field or a Require header field. It is RECOMMENDED, however, that the Supported header field be used in this case. The lack of preconditions in the answer would indicate that the answerer did not support this extension (RFC 3312, Integration of Resource Management and SIP, Section 11, October 2002).

SIP-002300 [Conditional] When an AS-SIP signaling appliance initiates an offer including one or more preconditions (where at least one strength-tag is “mandatory”), then the INVITE MUST include the option tag “precondition” include a Require header field with the option tag “precondition.”

SIP-002310 When an AS-SIP signaling appliance that does not support preconditions receives an offer including one or more preconditions and a Require header field with the option tag “precondition,” then the AS-SIP signaling appliance MUST respond with a 420 (Bad Extension) response code having an Unsupported header with the option tag “precondition.”

4.5.2.1 “Optional” Strength-Tag

SIP-002320 [Conditional] When an AS-SIP signaling appliance sends a precondition offer that includes precondition(s) all of whose strength-tag(s) are either “optional” or “none” and receives a 420 (Bad Extension) response code with an Unsupported header with the option tag “precondition,” then the default behavior for the AS-SIP signaling appliance is to retry the request and omit the precondition.

SIP-002330 [Conditional] If an AS-SIP signaling appliance that sends an sdp offer with preconditions (where all strength-tags are either “optional” or “none” and where the

“precondition” tag is placed in the Supported header NOT the Require header) receives one of the following:

- A 180 (Ringing) response does not include an sdp answer.
- (In the case of segmented preconditions) a 183 (Session Progress) response that does not include an sdp answer followed by a 180 (Ringing) response that does not include an sdp answer.
- A 18x with an sdp answer having no precondition attributes the AS-SIP signaling appliance MUST proceed with the standard call establishment procedure.

SIP-002340 [Conditional] If the sdp offer with preconditions (where all strength-tags are either “optional” or “none” and where the “precondition” tag is placed in the Supported header NOT the Require header) is sent by the terminating AS-SIP signaling appliance in response to a received INVITE (without SDP) and the SDP answer in the PRACK does NOT include precondition attributes then the call establishment MUST proceed as usual.

4.5.2.2 “Mandatory” Strength-Tag

SIP-002350 [Conditional] When an AS-SIP signaling appliance sends a precondition offer that includes at least one precondition whose strength-tag is “mandatory” and receives a 420 (Bad Extension) response code with an Unsupported header with the option tag “precondition,” then local policy will determine whether the AS-SIP signaling appliance retries the request without the precondition.

SIP-002360 [Conditional] When an AS-SIP signaling appliance sends an sdp offer with preconditions and receives a 580 (Precondition Failure) response code, then local policy will determine whether the AS-SIP signaling appliance retries the request without the precondition.

SIP-002370 [Conditional] When preconditions are implemented, then the AS-SIP signaling appliances are NOT required to support, or authorized to use, the segmented status type at the present time.

SIP-002380 [Conditional] If preconditions are implemented, then the implementation MUST be consistent with assured service precedence and preemption rules.

In particular, when preconditions are applied to a precedence call request (i.e., PRIORITY or higher) and the preconditions cannot be met, except for the preemption of one or more lesser precedence calls and/or call requests, then the lesser precedence call(s) and/or call requests MUST be preempted.

NOTE: Please see [Section 6](#), Precedence and Preemption, for details on the precedence and preemption requirements.

An example of the AS-SIP segmented status type precondition call flow is found at Requirement SIP-006150 and an example of the AS-SIP end to end status type precondition call flow is found in Requirement SIP-006140.

4.6 SIP URI AND MAPPING OF TELEPHONE NUMBER INTO SIP URI

Note: All AS-SIP signaling is exchanged over a TCP/TLS transport layer and all AS-SIP signaling appliances and AS-SIP EIs are required to generate SIP URIs for the AS-SIP messages transmitted over the TCP/TLS connections and to receive/process the SIP URIs in the AS-SIP messages received over the TCP/TLS connections. The UCR does not require AS-SIP signaling appliances or AS-SIP EIs to support SIPS URIs.

4.6.1 DSN Numbers

SIP-002390 When an SC receives a call request from a served IP EI intended for a destination outside the enclave and the dialed number is from the DSN worldwide numbering plan, then the SC MUST ensure that the userinfo part of the Request-URI field of the outbound INVITE forwarded by the SC is the complete 10-digit DSN number.

SIP-002390.a In the event the dialed number received from a served IP EI is a DSN number having fewer than the full 10 digits, then the SC MUST prepend the missing digits to create the full 10-digit DSN number.

SIP-002390.a.1 If the SC has insufficient information to create the full 10-digit DSN number based on the dialed number and the served IP EI is NOT an AS-SIP EI then the SC MUST arrange for the playing of the VCA “SC Name and Location. Your call cannot be completed as dialed. Please consult your directory and call again or ask your operator for assistance. This is a recording. SC Name and Location.” The EI is then instructed to terminate the call.

SIP-002400 When a call originates at an AS-SIP EI then the AS-SIP EI SHALL place the entire dialed string including prefix digits into the userinfo part of the Request-URI and the userinfo part of the SIP URI of the To header. In the case of a DSN number the dialed string consists of the prefix digits (i.e., access digit, precedence digit, and the route code (if present) followed by the dialed DSN number.

SIP-002400.a The SC serving the AS-SIP EI will process and strip off the prefix digits from the userinfo part of the Request-URI and from the userinfo part of the SIP URI of the To header, and if the dialed DSN number is less than a full 10-digit DSN number, then the SC MUST prepend the missing digits to create the full 10-digit DSN number.

NOTE: In compliance with RFC 3261 Sections 8.2.6.2 and 12.2.1.1 the SC SHALL place a copy of the original contents of the userinfo part of the To header received in the initial Request from the AS-SIP EI (i.e., the dialed string as received in the userinfo

part of the SIP URI of the To header of the initial AS-SIP EI request) into the userinfo part of the SIP URI of the To header of all SIP responses the SC forwards to the AS-SIP EI and into the userinfo part of the SIP URI of the From header of all in-dialog SIP requests received from the remote party that the SC forwards to the AS-SIP EI.

SIP-002400.a.1 If the SC has insufficient information to create the full 10-digit DSN number, then the SC establishes a bearer connection between the AS-SIP EI and a media server associated with the SC. See [Figure 4.6-1](#), Originating SC Implements Playing of VCA at AS-SIP EI when SC is Unable to Create a Full 10-Digit DSN Number for the userinfo Part of the Request-URI Field. The SC and media server exchange the necessary signaling to provide the media server with the IP address and UDP port for the bearer stream with the AS-SIP EI and the SC instructs the media server to play the VCA over the bearer stream to the AS-SIP EI once the bearer is established. The 183 (Session Progress) response sent by the SC to the AS-SIP EI includes the sdp answer with the IP address and UDP port for a bearer stream with the media server.

The AS-SIP EI responds with a PRACK to which the SC responds with a 200 (OK) response. The media server plays the announcement to the AS-SIP EI and terminates the session with the SC and the SC sends a 404 (Not Found) response to the AS-SIP EI. The AS-SIP EI responds with an ACK and terminates the call request.

NOTE: The media server is considered a part of the SC SUT; therefore, the signaling between the SC and media server is left to the vendor so long as the announcement is played and the signaling between the SC and AS-SIP EI complies with the specific call flow depicted in this section.

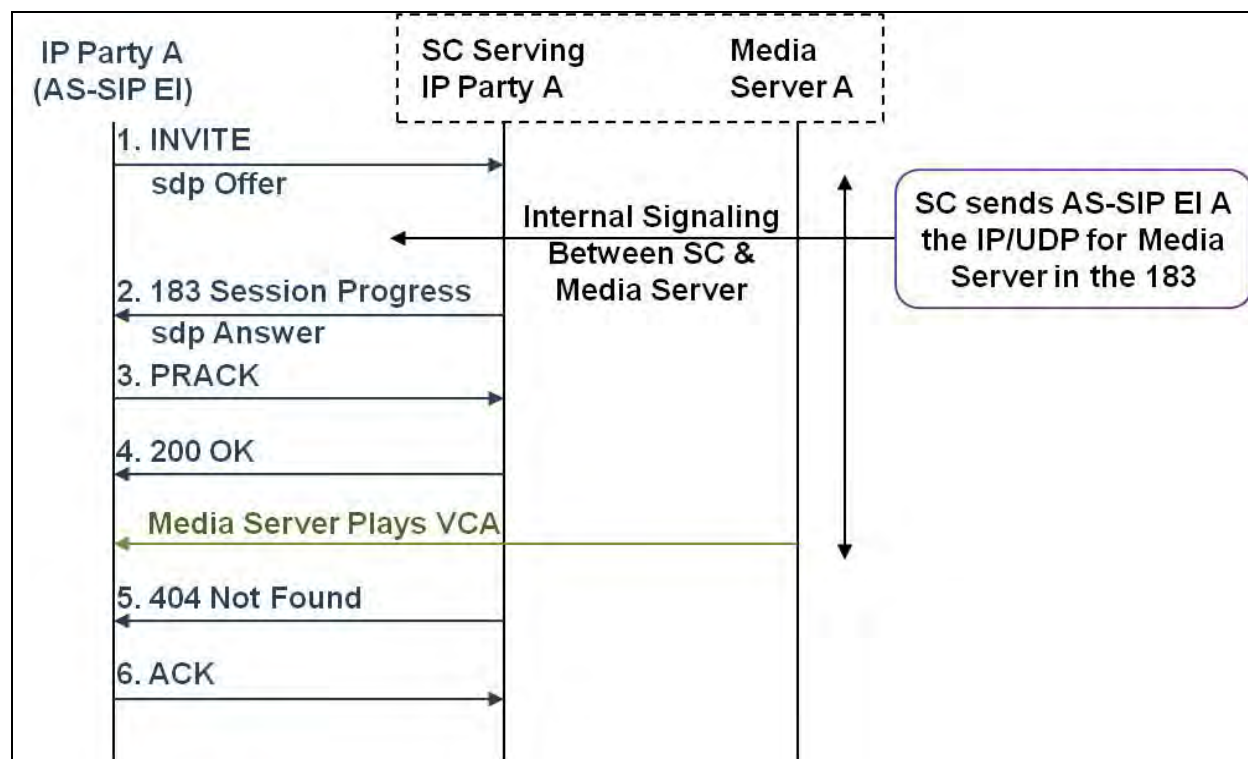

Figure 4.6-1. Originating SC Implements Playing of VCA at AS-SIP EI When SC Is Unable To Create a Full 10-Digit DSN Number for the Userinfo Part of the Request-URI Field

SIP-002410 When the SC serving an IP EI generates a SIP request or response, then the SC MUST place a full 10-digit number into the userinfo part of the SIP URI in the To header, From header, Contact header, and P-Asserted-Identity header⁵, Refer-To header (when present), and Referred-by header (when present) of SIP requests (See SIP-002400.1 for an additional clarification that applies when the SC is serving an AS-SIP EI).

SIP-002420 When an AS-SIP EI generates a SIP request or response and the AS-SIP EI knows the full 10-digit DSN number intended for the userinfo part of a SIP URI for the From header, Contact header, Refer-To header (when present), and Referred-by header (when present) then the AS-SIP EI MUST insert the full 10-digit DSN number otherwise the AS-SIP EI enters the known digits of the DSN number into the userinfo part of the SIP URI.

SIP-002420.a In the event an SC receives a request or response from a served AS-SIP EI in which the userinfo part of the SIP URI in any of the From header, Contact header, Refer-To header (when present), or Referred-by header (when present) does not have a full 10-digit DSN number then the SC MUST prepend the missing digits to create the full 10-digit DSN number.

⁵ A P-Asserted-Identity header is generated for the SIP INVITE request.

NOTE: If the SC modifies the value of the userinfo part of the SIP URI of the From header in order to generate a 10-digit DSN number then in compliance with RFC 3261 Sections 8.2.6.2 and 12.2.1.1 the SC SHALL place a copy of the original contents of the userinfo part of the From header received from the AS-SIP EI into the userinfo part of the SIP URI of the From header of all SIP responses that the SC forwards to the AS-SIP EI and into the userinfo part of the SIP URI of the To header of all subsequent in-dialog SIP requests received from the remote party that the SC forwards to the AS-SIP EI.

SIP-002430 In the event an SC receives an INVITE from a served AS-SIP EI⁶ or SIP EI intended for a destination outside the enclave and having a tel URI, then the SC MUST convert the tel URI to a SIP URI whereby the userinfo part of the SIP URI forwarded onward by the SC is the full 10-digit DSN number. This requirement applies to the Request-URI field and to the SIP URI of the To header, From header, Contact header, Refer-To header (when present), and Referred-by header (when present).

SIP-002440 An AS-SIP EI MUST generate a SIP URI and NOT a tel URI.

SIP-002450 The 10-digit DSN number MAY be followed by a phone-context descriptor consisting of a domain name (per RFC 3966).

SIP-002460 The userinfo part of the Request-URI field is derived from a telephone number (e.g., 10-digit DSN number) and the originating SC that generates a SIP request on behalf of a served IP EI MUST append a “user=phone” field to the Request URI.

SIP-002460.a The userinfo part of the SIP URIs of the To header, From header, Contact header, P-Asserted-Identity header (INVITE only), Refer-To header (when present), and Referred-by header (when present) are derived from telephone numbers and the originating SC that generates an initial request on behalf of a served IP EI MUST append a “user=phone” field to the SIP URIs of each of these headers (when present).

SIP-002470 When an AS-SIP EI generates an initial request the AS-SIP EI MUST append the “user=phone” field to the Request-URI and to the SIP URI of the To header, From header, Contact header, P-Asserted-Identity header (INVITE only), Refer-To header (when present), and Referred-by header (when present).

SIP-002470.a The event an SC receives an initial request from a served AS-SIP EI (or a SIP EI) that does not have the “user=phone” field, the SC SHALL append the “user=phone” field prior to forwarding the request onward.

NOTE: Per RFC 3261 Sections 8.2.6.2 and 12.2.1.1, if the initial request received from the served AS-SIP EI does not have the “user=phone” field appended to the SIP URI of the To header, then the SC SHALL remove the “user=phone” field from the SIP

⁶ An AS-SIP EI is required to generate a SIP URI and NOT a tel URI and an AS-SIP EI that sends an INVITE with a tel URI to its serving SC is not compliant with UCR [Requirement SIP-002440](#).

URI of the To header of all SIP responses that the SC forwards back to the AS-SIP EI and remove the “user=phone” field from the SIP URI of the From header of any subsequent ‘in dialog’ SIP requests received from the remote party before forwarding the SIP request to the AS-SIP EI. Similarly, if the initial request received from the served AS-SIP EI does not have the “user=phone” field appended to the SIP URI of the From header then the SC SHALL remove the “user=phone” field from the SIP URI of the From header of all SIP responses that the SC forwards back to the AS-SIP EI and remove the “user=phone” field from the SIP URI of the To header of any subsequent ‘in dialog’ SIP requests received from the remote party before forwarding the SIP request to the AS-SIP EI.

SIP-002480 When the SC generates a response or a subsequent request within a dialog on behalf of an IP EI then the SC SHALL append the “user=phone” field to the SIP URI of the Contact header, Refer-To header (when present), Referred-by header (when present), To header and the From header subject to the following caveat:

Caveat: If the original dialog initiating request (e.g. the original INVITE) had been generated by a remote party and had not included the “user=phone” field in the To header and From header when received by the SC, then per RFC 3261 Sections 8.2.6.2 and 12.2.1.1 the SC will not append the “user=phone” field to the SIP URIs in the To header and the From header of the responses and subsequent ‘in dialog’ requests sent to the remote party.

SIP-002490 When the AS-SIP EI generates a response or a subsequent request within a dialog then the AS-SIP EI SHALL append the “user=phone” field to the SIP URI of the Contact header, Refer-To header (when present), Referred-by header (when present), To header and the From header subject to the following caveat:

Caveat: The AS-SIP EI MUST NOT append the “user=phone” field to the SIP URIs of the To header and From header of responses and requests within a dialog if one of the following occurs:

- The AS-SIP EI generated the original request and did not append the “user=phone” field to the SIP URIs of the To header and the From header.
- The original request was generated by a remote party and when received by the AS-SIP EI the original request had not had the “user=phone” field appended to the To header and the From header.

SIP-002500 When an AS-SIP signaling appliance receives from another AS-SIP signaling appliance an INVITE with a Request-URI where the userinfo part is a full 10-digit DSN number either with or without a phone-context descriptor, the AS-SIP signaling appliance MUST be able to forward the INVITE to the next appropriate AS-SIP signaling appliance or EI.

SIP-002510 The hostname of the Request-URI field of an outbound INVITE sent by the SC to its SBC and intended for a destination outside the enclave **MUST** be a UC network name. A UC network name is a hostname that consists of one of the following:

- A network domain name that identifies the DoD network to which the appliance belongs. At minimum, the hostname may simply be “uc.mil” (for the SBU network) or “cuc.mil” (for the classified network).
- A network domain name that more precisely identifies the DoD network up to and including the FQDN to which the appliance belongs such as “scott.conus.uc.mil.”
- An appliance FQDN that consists of the FQDN for the SC (e.g., “SC5.mfss50.scott.conus.uc.mil”).

SIP-002510.a The hostname of the Request-URI field of an INVITE sent by an AS-SIP EI **MUST** be a UC network name.

SIP-002520 The hostname of the SIP URI of the To header, From header, P-Asserted-Identity header (INVITE request), Refer-To header (when present), and Referred-by header (when present) of a SIP request or response that traverses the UC network **MUST** be a UC network name. The SC (serving an IP EI) that generates a SIP request or response **MUST** place a UC network name in the hostname part of the SIP URI of these headers.

SIP-002520.a The hostname of the SIP URI of the To header, From header, P-Asserted-Identity header, Refer-To header (when present), and Referred-by header (when present) of a SIP request or response generated by an AS-SIP EI **MUST** be a UC network name.

SIP-002520.b The hostname of the SIP URI in the Contact header of a SIP request or response forwarded by an SC, SBC, or SS implemented as a B2BUA **MUST** be a routable IP address.

SIP-002520.c The hostname of the SIP URI in the Contact header of a SIP request or response generated by an AS-SIP EI or by an SC serving an IP EI implemented as a proxy, or forwarded by an SC, SS, or SBC implemented as a proxy, either **MAY** be a routable IP address or a UC network name.

4.6.2 N11 Service Codes

SIP-002530 When an SC receives an emergency call request (e.g., 911, 112) (or a service code such as directory assistance (e.g., 411) or any other N11 service code) from a served IP EI and the emergency call request is to be sent outside the enclave over the UC core, then the Request-URI field **MUST** be a SIP URI in which the userinfo part is 411 (or 911 or 112), the “phone-context” parameter **MUST** be included and **MUST** have the value servicecode.uc.mil, the

hostname MUST be a UC network name⁷ and the “user=phone” field MUST be appended to the SIP URI.

NOTE: This requirement is meant to support the deployable scenario.

SIP-002540 As with all call requests originating at an AS-SIP EI, when a user at an AS-SIP EI dials an emergency call request or any other N11 service code then the AS-SIP EI SHALL place the entire dialed string including prefix digits, if present, into the userinfo part of the Request-URI of the INVITE.

SIP-002540.a Upon receiving the INVITE from the served AS-SIP EI, the SC SHALL do the following:

- Process and strip off the prefix digits (if present).
- Leave the 3-digit service code in the userinfo part of the Request-URI.
- Add the “phone-context” parameter having the value: servicecode.uc.mil.
- Ensure that the hostname part of the Request-URI received from the AS-SIP EI has a valid and appropriate UC network name and, if not, replace the hostname part of the Request-URI with a valid UC network name.
- Append “user=phone” field to the Request-URI.

SIP-002550 The telephone number in the userinfo part of the SIP URI of the P-Asserted-Identity header generated by the originating SC is the default call back phone number for the 911 call. In the event the P-Asserted-Identity header is not present in the INVITE, then the userinfo part of the SIP URI of the From header is used as the call back phone number.

4.6.3 PSTN Numbers

SIP-002560 When an SC receives a call request from a served IP EI intended for the Public Switched Telephone Network (PSTN) that is to be routed through the UC network (as opposed to being routed directly to a PSTN gateway at the enclave), then the userinfo part of the Request-URI field of the outbound INVITE forwarded by the SC MUST be represented in global E.164 notation.

SIP-002560.a When the call request intended for the PSTN is to be routed through the UC network then the userinfo part of the SIP URI of the To header, From header, Contact header, and P-Asserted-Identity header will be a PSTN number represented in global E.164 notation.

⁷ A UC network name has a top level having the value “mil,” a second level having the value “uc” i.e., “uc.mil” and MAY assume any of the following formats. The hostname may be simply “uc.mil” or the hostname may be a more precise UC network name whose top level and second level are “mil” and “uc” (e.g., scotta.fb.uc.mil), or the hostname may be a FQDN whose top level domain is “mil” and whose second level domain is “uc.”

NOTE: In the case of a call originating on the PSTN that is interworked over the UC network (as opposed to being interworked locally through a PSTN gateway at the enclave) there are circumstances when the interworking of a “CPN” parameter to the From header results in a SIP URI whose userinfo part is “unavailable” and whose hostname is the hostname of the originating gateway and not “uc.mil.” There are also circumstances when the SIP URI in the From header may be “anonymous @anonymous.invalid” or may have no userinfo part and only the hostname of the originating gateway. The AS-SIP signaling appliances **MUST NOT** reject the AS-SIP message simply because the From header has a SIP URI that takes any of these forms.

SIP-002560.b The format of a SIP URI that includes a global E.164 number in the userinfo part is:

sip:+<E.164number>@hostname;user=phone

where the E.164 number replaces <E.164number> including the left and right angle brackets

NOTE 1: The ‘+’ sign **SHALL** always be prepended to the global E.164 number.

NOTE 2: In the case of an international call the user dials an international access code (e.g. 011 when dialed from the United States, 00 when dialed from a European country) prior to dialing the country code and national number. However, the international access code is **NOT** included in the userinfo part of the SIP URI generated by the SC. It is understood that the presence of the ‘+’ sign signifies a global E.164 number whose initial digit(s) are the country code. This information is sufficient to properly route an international call.

SIP-002570 The AS-SIP EI **SHALL** place the entire dialed string including prefix digits into the userinfo part of the Request-URI. In the case of a PSTN number the dialed string consists of the prefix digits (i.e., access digit, service digit, and the route code (if present)) followed by the dialed PSTN number.

NOTE: In the case of an international call the PSTN number will be prepended by the international access code (e.g. 011 when dialed in the United States, 00 when dialed in a European country). Therefore, in the case of an international call the dialed string consists of: prefix digits (i.e., access digit, service digit, and the route code [if present]) followed by the international access code followed by the PSTN number.

SIP-002570.a The SC serving the AS-SIP EI **SHALL** do the following:

- Process and strip off the prefix digits (and the international access code if present) from the userinfo part of the Request-URI received from the AS-SIP EI

- If the PSTN number is a global E.164 number then the SC prepends the '+' sign to the global E.164 number and places this value in the userinfo part of the Request-URI that it forwards onward
- If the PSTN number is not a global E.164 number and the SC has the requisite knowledge to generate a global E.164 number then the SC generates a global E.164 number, prepends the '+' sign, and places this value in the userinfo part of the Request-URI that it forwards onward.
- If the PSTN number is not a global E.164 number and the SC does not have the requisite knowledge to generate a global E.164 number then the SC establishes a bearer connection between the AS-SIP EI and a media server associated with the SC. See [Figure 4.6-2](#), Originating SC Implements Playing of VCA at AS-SIP EI when SC is Unable to Create a Global E.164 Number for the Userinfo Part of the Request-URI Field.
 - The SC and media server exchange the necessary signaling to provide the media server with the IP address and UDP port for the bearer stream with the AS-SIP EI and the SC instructs the media server to play the VCA over the bearer stream to the AS-SIP EI once the bearer is established. The 183 (Session Progress) response sent by the SC to the AS-SIP EI includes the sdp answer with the IP address and UDP port for a bearer stream with the media server.
 - The AS-SIP EI responds with a PRACK to which the SC responds with a 200 (OK) response. The media server plays the announcement to the AS-SIP EI and terminates the session with the SC and the SC sends a 404 (Not Found) response to the AS-SIP EI. The AS-SIP EI responds with an ACK and terminates the call request.

NOTE: The media server is considered a part of the SC SUT; therefore, the signaling between the SC and media server is left to the vendor so long as the announcement is played and the signaling between the SC and AS-SIP EI complies with the specific call flow depicted in this section.

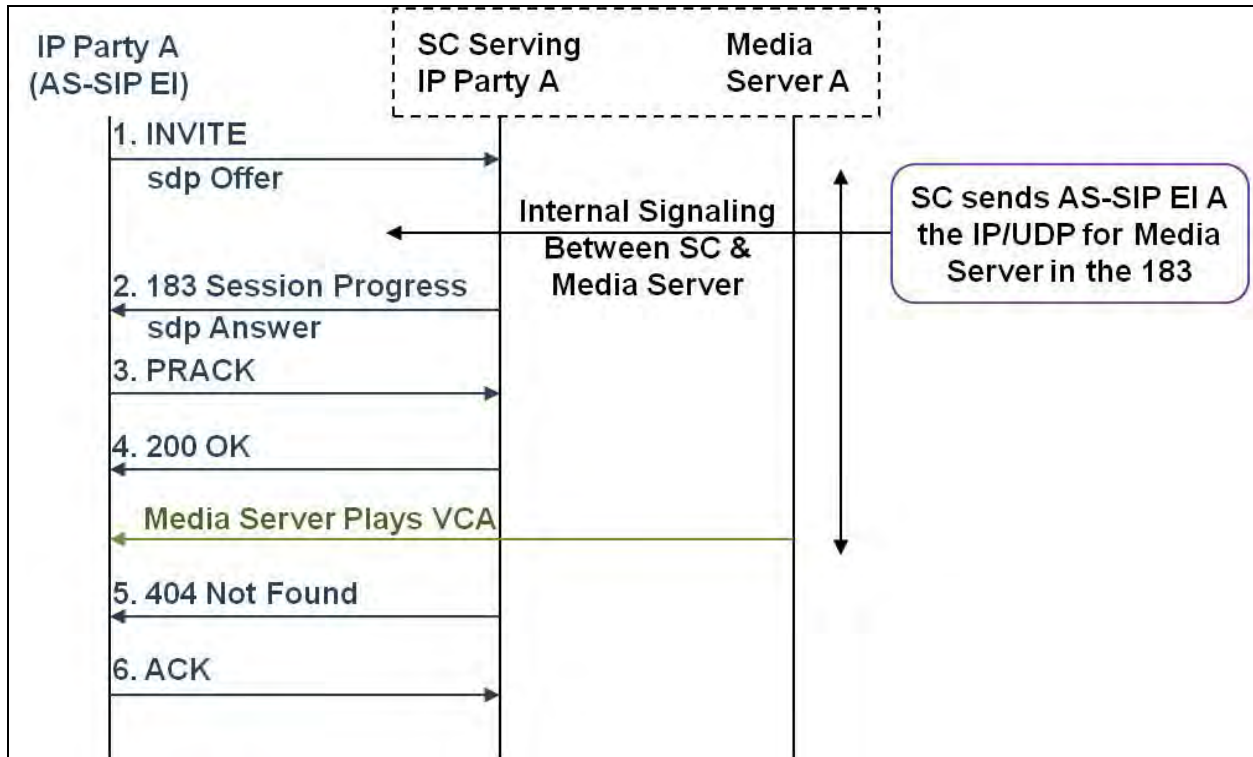

Figure 4.6-2. Originating SC Implements Playing of VCA at AS-SIP EI When SC Is Unable To Create a Global E.164 Number for the Userinfo Part of the Request-URI Field

SIP-002580 When an AS-SIP signaling appliance receives from another AS-SIP signaling appliance an INVITE with a Request-URI where the userinfo part is a global E.164 number, the AS-SIP signaling appliance MUST be able to forward the INVITE to one of the following:

- The next appropriate AS-SIP signaling appliance.
- If the given AS-SIP signaling appliance is the interworking gateway, then conduct the SIP to ISDN or SS7 signaling plane interworking of the SIP INVITE request.
- A served EI (applicable to SC only).

SIP-002590 When an SC receives a call request from a served IP EI intended for the PSTN that is to be routed through the UC network (as opposed to being routed directly to a PSTN gateway at the enclave), then the hostname of the Request-URI field of the outbound INVITE sent by the SC to its SBC and intended for a PSTN gateway outside the enclave MUST be a UC network name.

The hostname of the Request-URI field MUST remain a UC network name until the INVITE leaves the UC network.⁸

NOTE: In the case of the classified network, the value for the second level of the UC network name is “cuc.”

SIP-002590.a The hostname of the Request-URI field of an INVITE sent by an AS-SIP EI and intended for the PSTN MUST be a UC network name.

SIP-002590.b The hostname of the SIP URI of the To header, From header, P-Asserted-Identity header, Refer-To header (when present), and Referred-by header (when present) of a SIP request or response that traverses the UC network to or from a PSTN gateway MUST be a UC network name. The SC serving an IP EI or the SC or SS acting as an interworking gateway that generates a SIP request or response MUST place a UC network name in the hostname part of the SIP URI of these headers.

SIP-002590.c The hostname of the SIP URI of the To header, From header, P-Asserted-Identity header, Refer-To header (when present), and Referred-by header (when present) of a SIP request or response generated by an AS-SIP EI and intended for the PSTN MUST be a UC network name.

SIP-002590.d The hostname of the SIP URI in the Contact header of a SIP request or response forwarded by an SC, SBC, or Softswitch implemented as a B2BUA MUST be a routable IP address.

SIP-002590.e The hostname of the SIP URI in the Contact header of a SIP request or response generated by an AS-SIP EI or by an SC serving an IP EI implemented as a proxy or forwarded by an SC, softswitch, or SBC implemented as a proxy either MAY be a routable IP address or a UC network name.

4.6.4 Example Request-URI Fields

Following are four examples of the Request-URI field of an outbound INVITE sent by the AS-SIP signaling appliance serving an IP EI toward the UC core:

10-Digit DSN Number:

```
sip:3154561223;phone-context=uc.mil@pac.uc.mil;user=phone  
sip:3154561223@pac.us.mil;user=phone
```

⁸ If an AS-SIP signaling appliance forwards an INVITE to a database server such as a LNP database server or other external location server then the hostname is NOT constrained to be a UC network name. For example, under said circumstances the hostname MAY be a routable IP address.

3-Digit Service Code:

sip:911;phone-context=servicecode.uc.mil@pac.uc.mil;user=phone

PSTN Number:

sip:+12135431234@scottafb.uc.mil;user=phone

4.7 64 KBPS TRANSPARENT CALLS (CLEAR CHANNEL)

SIP-002600 [Required: Fixed installations – Conditional: Deployable environments] When an AS-SIP signaling appliance performs the Media Gateway Controller (MGC) function for an MG, then the AS-SIP signaling appliance MUST support the establishment of 64 Kbps unrestricted RTP bearer streams IAW RFC 4040.

SIP-002600.a When an AS-SIP signaling appliance (i.e., originating AS-SIP signaling appliance) receives a Q.931 SETUP message where the bearer capability information element (IE) indicates that the bearer is 64 Kbps unrestricted, then the AS-SIP signaling appliance MUST generate and send an outbound AS-SIP INVITE that includes the “SDP” parameters as specified in RFC 4040 as follows:

- The media (“m=”) field is assigned the value audio.

NOTE: The media field is described in detail in Section 5.3.1, Media (“m=”) Field.

- The attribute (“a=”) field is assigned the value CLEARMODE/8000.

NOTE: The attribute field is described in detail in [Section 5.3.3](#), SIP-003590, Attributes (“a=”) Fields.

- The a=ptime attribute and the a=maxptime attribute MAY be included in the SDP description.

NOTE: The attributes a=ptime and a=maxptime are described in detail in SIP-003590.

Example from RFC 4040:

```
m=audio 12345 RTP/AVP 97
a=rtpmap:97 CLEARMODE/8000
a=ptime:10
```

SIP-002610 The originating AS-SIP signaling appliance MUST direct the MG to reserve the resources for the clear channel packetization/depacketization and to conduct the transparent relay of the 64 Kbps bearer stream using RTP upon completion of session establishment.

SIP-002620 When an AS-SIP signaling appliance (i.e., terminating AS-SIP signaling appliance) (acting as an MGC for an MG) receives an AS-SIP INVITE intended for the TDM network where the “SDP” parameters have a media field = audio and an attribute field =

CLEARMODE/8000, then the AS-SIP signaling appliance MUST create a Q.931 SETUP message with a bearer capability IE indicating that the bearer is 64 Kbps unrestricted (depending on local policy).

SIP-002630 The terminating AS-SIP signaling appliance MUST direct the MG to reserve the resources for the clear channel packetization/depacketization and to conduct the transparent relay of the 64 Kbps bearer stream using RTP upon completion of session establishment.

4.8 TRANSPORT OF ROUTE CODE INFORMATION OVER AS-SIP

SIP-002640 When an EI is served by an SC, then the SC is responsible for ensuring that the route code information dialed by the user is represented in the outbound INVITE message sent over the interface toward the UC WAN by appending the “tgrp” parameter and the “trunk-context” parameter to the userinfo part of the SIP URI of the Request URI as described in this subsection (RFC 4904).

SIP-002650 When the user of an AS-SIP EI enters route code digits 11 or 12, then the route code digits constitute a component of the prefix digits of the dialed string placed into the userinfo part of the Request-URI of the INVITE and the userinfo part of the To header of the INVITE sent by the AS-SIP EI to the SC per requirement SIP-002400. The SC is responsible for processing the route code digits and appending the “tgrp” parameter and the “trunk-context” parameter to the userinfo part of the Request URI as described in this subsection (RFC 4904).

SIP-002650.a [Table 4.8-1](#), Route Code Digits Input by Caller and Corresponding “tgrp,” “trunk-context,” provides the correspondence between the route code entered during user dialing and the associated value for the “tgrp” parameter and the “trunk-context” parameter.

Table 4.8-1. Route Code Digits Input by Caller and Corresponding “tgrp” “trunk-context”

ROUTE CODE (ENTERED BY USER)	ROUTE CODE USE	“TGRP”	“TRUNK-CONTEXT”
10	Voice Call (default)	N/A (see note)	N/A
11	Circuit Switched Data	tgrp=ccdata	trunk-context=uc.mil
12	Satellite Avoidance	tgrp=nosat	trunk-context=uc.mil

NOTE: 10 represents a voice call and is the default route code. Do not append a “tgrp” parameter and a “trunk-context” parameter to the Request-URI of calls where the route code has the value 10. The absence of the “tgrp” parameter and “trunk-context” parameter is intended to signify to AS-SIP signaling appliances that the instant INVITE represents a voice call.

SIP-002660 When an EI initiates a hotline call, then the SC MUST append a “tgrp” parameter and a “trunk-context” parameter to the userinfo part of the Request URI of the INVITE message where the values are defined in [Table 4.8-2](#), “tgrp” and “trunk-context” Parameters Inserted for Hotline Calls.

Table 4.8-2. “tgrp” and “trunk-context” Parameters Inserted for Hotline Calls

ROUTE CODE	ROUTE CODE USE	“TGRP”	“TRUNK-CONTEXT”
5	Hotline (off-hook) voice grade (inserted by AS-SIP signaling appliance)	tgrp=hotline	trunk-context=uc.mil
6	Hotline (off-hook) data grade (inserted by AS-SIP signaling appliance)	tgrp=hotline-ccdata	trunk-context=uc.mil

NOTE: The user does not dial these route codes. The AS-SIP signaling appliance shall automatically dial hotline calls when an off-hook condition occurs and convey the appropriate “tgrp” parameter and “trunk-context” parameter as specified in this table.

SIP-002670 When an AS-SIP EI a hotline call then the SC MUST append a “tgrp” parameter and a “trunk-context” parameter to the userinfo part of the Request URI of the INVITE message where the values are defined in [Table 4.8-2](#), “tgrp” and “trunk-context” Parameters Inserted for Hotline Calls.

Example:

sip:3153435335;phone-context=uc.mil;tgrp=hotline;trunk-context=uc.mil@patch.uc.mil; user=phone

SIP-002680 For the reader’s convenience, [Table 4.8-3](#), SIP tgrp to ISDN Q.931 Mapping, shows the mapping of the SIP tgrp value to the ISDN Q.931 IE field/bearer capability.

Table 4.8-3. SIP tgrp to ISDN Q.931 Mapping

SIP TGRP=VALUE	Q.931 IE/ BEARER CAPABILITY
No label	Voice BC
tgrp=ccdata	56/64 Kbps circuit-mode data
tgrp=nosat	N/A – not defined
tgrp=hotline	Off-hook indicator of voice, speech BC
tgrp=hotline-ccdata	Off-hook indicator of data, 56/64 Kbps cmd BC

LEGEND

BC: Bearer Capability	Kbps: Kilobits per second
cmd: Circuit Mode Data	N/A: Not Applicable
IE: Information Element	SIP: Session Initiation Protocol

SIP-002690 Whenever an SC or SS acting as an originating gateway receives either a Q.931 SETUP message where the bearer capability IE indicates that the bearer is 56/64 Kbps circuit mode data or an SS7 IAM where the “TMR” parameter [International Telecommunications Union – Telecommunication (ITU-T) Integrated Services Digital Network User Part (ISUP)] is 64 Kbps unrestricted or the “USI” parameter [American National Standards Institute (ANSI) ISUP] is 64 Kbps unrestricted digital information, then the AS-SIP signaling appliance MUST do the following:

- Set the “tgrp” parameter to ccddata (i.e., tgrp=ccddata) and append the “tgrp” parameter to the userinfo part of the Request URI.
- Set the “trunk-context” parameter to uc.mil (i.e., trunk-context=uc.mil) and append the “trunk-context” parameter to the userinfo part of the Request-URI.

SIP-002700 Whenever an SC or SS acting as a terminating gateway receives an INVITE with a Request-URI having the “tgrp” parameter set to “ccddata” and having the “trunk-context” parameter set to “uc.mil,” then the following will occur:

- If the INVITE is being interworked to ISDN, then the bearer capability IE in the Q.931 SETUP message MUST be set to unrestricted digital information, circuit mode.
- If the INVITE is being interworked to SS7, then in the case of ITU-T ISUP the “TMR” parameter in the IAM MUST be set to “64 kbit/s unrestricted,” and in the case of ANSI ISUP, the “USI” parameter in the IAM MUST be set to “unrestricted digital information.”

4.9 CONFIDENTIALITY ACCESS LEVEL GENERAL REQUIREMENTS

NOTE: CAL Paragraphs apply to Classified only. It is assumed the reader has some familiarity with the function and operation of Security Access Level (SAL) maps whereby an incoming access value is resolved against a locally configured access value to obtain the resolved access value. A simple way to conceptualize the SAL map is to consider a 2-dimensional x-y matrix vector with the incoming access value (located in the CAL header – described in [Section 4.9.1](#), CAL Header) as the x-value and the locally configured value for the next destination as the y-value. The resolved value is found at the intersection of the x-value and y-value. The resolved value replaces the incoming value in the CAL header and the signaling message is forwarded to the next destination.

This section describes the requirements for conveying the confidentiality level for a communication session between two or more EIs. A new SIP header, the CAL header, conveys classification level information between the UAC and the UAS. Each SC and SS in the signaling path of a call request obtains the incoming access value from specific fields in the CAL header and resolves this incoming value with the locally configured value associated with the next destination by means of a SAL map look-up.

For purposes of this section, it is stipulated that the EI has been activated to support one or more classification levels based upon the prior successful completion of a user authentication process.

4.9.1 CAL Header

In this section, we define the CAL header whose purpose is to convey the classification level for a telephony or video session between the parties to the session.

SIP-002710 The syntax for the CAL header is as follows:

Confidential-Access-Level	=	“Confidential-Access-Level” HCOLON local-access-level SEMI reflected-access-level [SEMI access-display]
local-access-level	=	(access-level SEMI access-mode)
reflected-access-level	=	(“ref” EQUAL access-level SEMI reflected-mode)
access-level	=	(1*2DIGIT ; 0 to 99)
access-mode	=	(“mode” EQUAL mode-param)
reflected-mode	=	(“rmode” EQUAL mode-param)
mode-param	=	(fixed/ variable)
access-display	=	(1*16display-text)
display-text	=	ALPHA/DIGIT/SP/”!””@””#””\$””%””^””&””*”””(“/”””-“”_””+””=””{“”}””}[“”]”

NOTE: The EI MUST support display of right justified, left justified, and center justified text.

SIP-002720 The access-display field is set to PENDING until the confidentiality level is fully resolved by the SC serving the intended recipient of the INVITE request.

The following are examples showing the Confidential-Access-Level header in an initial INVITE:

```
Confidential-Access-Level: 4;mode=variable;ref=0;rmode=fixed;PENDING
Confidential-Access-Level: 2;mode=variable;ref=0;rmode=variable;SECRET
(Example of CAL sent by terminating SC to served AS-SIP EI)
```

The following are examples showing the Confidential-Access-Level header in a 200 (OK) response:

```
Confidential-Access-Level: 4;mode=fixed;ref=4;rmode=fixed;TOP SECRET
Confidential-Access-Level: 7;mode=variable;ref=6;rmode=variable;SECRET
US/FORN
```

4.9.1.1 mode-param Field

SIP-002730 If an SC or SS receives an INVITE with a CAL header whose value for the access-mode field is “fixed,” then to forward the INVITE onward, the SC or SS MUST support the exact value of the access-level in the local-access-level field found in the received CAL header.

SIP-002730.a If the SC or SS does not support the value of the access-level in the local-access-level field found in the received CAL header and the value of the access-mode field is “fixed,” then the SC or SS MUST respond with a 418 (Incompatible CAL) response code.

SIP-002740 If an SC or SS receives an INVITE with a CAL header whose value for the access-mode field is “variable,” then the SC or SS does NOT need to support the exact value of the access-level in the local-access-level field found in the received CAL header and the value of the access-level in the local-access-level field is allowed to change when the INVITE traverses the SC or SS.

SIP-002750 If the value of the access-mode in a CAL header of an INVITE received by an SC or SS is different from the value of the locally configured access-mode at the SC or SS, then if the INVITE is forwarded onward the value of the access-mode MUST be fixed.

4.9.2 Presence of CAL Header in INVITE Requests, 200 Responses, 418 Responses

SIP-002760 The CAL header MUST be present in the initial INVITE generated or forwarded by the originating SC that is intended to establish a new dialog.

SIP-002770 The CAL header MUST be present in the 200 (OK) response generated or forwarded by the terminating SC signifying the initial INVITE request has succeeded.

SIP-002780 The CAL header MUST NOT be present in a re-INVITE generated by an SC serving an IP EI.⁹¹⁰

SIP-002790 The CAL header MAY be present in a re-INVITE generated or forwarded by an SC serving a multipoint conferencing unit (MCU) upon the event of a party entering or exiting a multiparty session.

SIP-002800 The CAL header MUST be present in any 200 response to a re-INVITE that has a CAL header that is forwarded or generated by the SC serving the IP EI that is the recipient of the re-INVITE. If the re-INVITE does not have a CAL header, then the 200 response MUST NOT have a CAL header.

SIP-002810 The CAL header MUST be present in any 418 (Incompatible CAL) response code that is sent by an AS-SIP signaling appliance that is unable to grant the classification request in the CAL header of an INVITE (or re-INVITE) in the case of a fixed mode request or is unable to satisfactorily resolve the classification request to an acceptable value in the case of a variable mode request.

⁹ A CAL header may be generated by an SC serving a MCU (see Requirement SIP-002910).

¹⁰ A later revision of CAL requirements may modify this particular requirement to enable renegotiation of the confidentiality level of parties to three-way calls when the call legs are bridged at an SC or at an IP EI.

4.9.3 AS-SIP EIs and SIP EIs Do NOT Generate CAL Header

SIP-002820 The SIP EIs and AS-SIP EIs MUST NOT add a CAL header to an initial INVITE.

NOTE: If an SC receives an initial INVITE that has a CAL header from a served SIP EI or AS-SIP EI, then the SC MUST replace the CAL header received in the initial INVITE from the served SIP EI or AS-SIP EI with a CAL header generated by the SC itself.

SIP-002830 The SIP EIs and AS-SIP EIs MUST NOT add a CAL header to a 200 response to an initial INVITE.

NOTE: If an SC receives a 200 response that has a CAL header from a served SIP EI or AS-SIP EI, then the SC MUST replace the CAL header received in the 200 response to the initial INVITE with a CAL header generated by the SC itself.

SIP-002840 The SIP EIs and AS-SIP EIs MUST NOT add a CAL header to a re-INVITE.

NOTE: In the case of a multiparty call in the event that either a new party is added to the call or an existing party exits the call, then the MCU and SC serving the MCU are responsible, if necessary, for generating re-INVITES with CAL headers to adjust the confidentiality level of the multiparty session.

NOTE: If an SC serving a SIP EI or AS-SIP EI receives a re-INVITE with a CAL header for a served SIP EI or AS-SIP EI, then the SC MUST remove the CAL header from the re-INVITE before forwarding the re-INVITE onward.

SIP-002850 The SIP EIs and AS-SIP EIs MUST NOT add a CAL header to a 200 response to a re-INVITE.

NOTE: The SC serving the SIP EI or AS-SIP EI will replace the CAL header received in the 200 response to a re-INVITE from the served SIP EI or AS-SIP EI with a CAL header generated by the SC itself.

SIP-002860 The SIP EIs and AS-SIP EIs MUST place the value of the DN associated with the classification level selected by the user initiating the call into the userinfo part of the SIP URI in the From header of an initial INVITE (i.e., an initial INVITE is an INVITE intended to establish a dialog). In the event the user is authorized for only one classification level, then the SIP or AS-SIP EI MUST place the corresponding DN in the userinfo part of the SIP URI in the From header.

NOTE: The SC serving the SIP EI or AS-SIP EI generates the CAL based on the DN in the userinfo part of the SIP URI in the From header after verifying that the DN is valid for the current user of the EI (who has previously undergone an authentication process to use the EI).

SIP-002870 When a SIP EI or AS-SIP EI that sent the original INVITE subsequently sends a re-INVITE, then the DN in the userinfo part of the SIP URI in the From header of the re-INVITE MUST be identical to the DN in the userinfo part of the SIP URI in the From header of the original INVITE.

4.9.4 Generating the CAL Header – SC

SIP-002880 Upon receipt of an initial outbound call request from a served non-SIP, non-AS-SIP IP EI (that is currently activated to support one or more classification levels), the SC MUST generate an INVITE that includes a CAL header. The SC looks up the applicable classification and mode (fixed or variable) based on the DN associated with the served EI and MUST enter the configured numeric classification level and the mode in the local-access-level of the CAL header, set the value of the reflected-access-level to 0, set the reflected-mode to either ‘fixed’ or ‘variable’, and place the text PENDING in the access-display field.

NOTE: The reflected-access-level in the INVITE or in a re-INVITE is not used by any recipient SC, SS, or AS-SIP EI therefore if the value of the reflected-access-level in the INVITE or re-INVITE is not set to 0 then the recipient SC MUST continue to process the CAL header in the forward direction and a recipient AS-SIP EI MUST accept the CAL header and display the text for the resolved access level.

SIP-002880.a If the source DN in the call request or other information identifying the classification that was selected by the user does not match an authorized DN for the given IP EI then the SC MUST reject the call request and ensure that the text “CAL rejected” is displayed on the caller’s IP EI.

SIP-002890 Upon receipt of an initial outbound INVITE from a served SIP EI or served AS-SIP EI intended to establish a new session, the SC MUST determine whether the DN in the From header matches an authorized DN for the given SIP EI or AS-SIP EI:

SIP-002890.a If the DN in the From header matches an authorized DN for the given SIP EI or AS-SIP EI, then the SC MUST add a CAL header to the INVITE. The SC selects the applicable classification and mode (fixed or variable) based on the DN in the userinfo part of the SIP URI in the From header and MUST enter the configured numeric classification and mode in the local-access-level of the CAL header (see [Section 4.9.3](#), AS-SIP EIs and SIP EIs Do NOT Generate CAL Header), set the value of the reflected-access-level to 0, set the reflected-mode to either ‘fixed’ or ‘variable’, and place the text PENDING in the access-display field. If the initial INVITE received from the served SIP EI or AS-SIP EI has a CAL header, the SC MUST replace the received CAL header with the CAL header that the SC itself generates.

NOTE: The reflected-access-level in the INVITE or in a re-INVITE is not used by any recipient SC, SS, or AS-SIP EI therefore if the value of the reflected-access-level in the INVITE or re-INVITE is not set to 0 then the recipient SC MUST continue to

process the CAL header in the forward direction and a recipient AS-SIP EI MUST accept the CAL header and display the text for the resolved access level.

SIP-002890.b If the DN in the From header does not match an authorized DN for the given AS-SIP EI then the SC MUST send a 418 (Incompatible CAL) response to the AS-SIP EI and the AS-SIP EI MUST display the text “CAL rejected” to the caller.

SIP-002890.c If the DN in the From header does not match an authorized classified DN for the given SIP EI then the SC MUST reject the call request and ensure that the text “CAL rejected” is displayed on the caller’s SIP EI.

SIP-002900 In the case of an SC serving an MCU, upon the event of a party entering or exiting the session the SC MAY generate one or more re-INVITEs with CAL headers to modify the classification level of the session for the current set of parties.¹¹

SIP-002910 When an SC generates or forwards a re-INVITE from a served IP EI the SC MUST NOT place a CAL header in the re-INVITE request.¹²

SIP-002910.a If an SC receives a re-INVITE with a CAL header from a served SIP EI or AS-SIP EI then the SC removes the CAL header before forwarding the re-INVITE onward.

4.9.5 Confidential-Access-Level Option Tag

SIP-002920 The originating SC that adds the CAL header to an INVITE MUST include a Require header with the option tag “confidential-access-level” and MUST include a Proxy-Require header with the option tag “confidential-access-level” unless the CAL header is not required for the session.

4.9.6 (Incompatible CAL) Response

SIP-002930 When an AS-SIP signaling appliance (i.e., SC or SS) in the signaling path between parties receives an initial INVITE with a CAL header that the AS-SIP signaling appliance cannot successfully resolve against the locally configured value of the next hop routing domain per [Section 4.9.7](#), CAL Header Processing, then the AS-SIP signaling appliance MUST respond with a 418 Incompatible CAL.

SIP-002940 The 418 response MUST contain a CAL header in which the local-access-level is set to the classification level and mode that is supported by the AS-SIP signaling appliance that is responding with the 418 and the reflected-access-level is set to the last successfully resolved

¹¹ We do not specify whether the MCU or the SC initiates the modification of the classification level and this is a design and implementation decision that is left to the vendors.

¹² A later revision of CAL requirements may modify this particular requirement to enable renegotiation of the confidentiality level of parties to three-way calls when the call legs are bridged at an SC or at an IP EI.

value in the request path. In addition, the text provided in the access-display field MUST be: CAL MISMATCH.

SIP-002950 In the event the originating IP EI is not an AS-SIP EI and the originating SC serving the IP EI receives a 418 response then the originating SC MUST ensure that the IP EI displays the text: “CAL MISMATCH” and that a reorder tone is played to the user for a minimum of 3 seconds.

SIP-002960 In the event the originating IP EI is an AS-SIP EI and the originating SC serving the AS-SIP EI receives a 418 response then the originating SC MUST send the 418 response to the AS-SIP EI and the AS-SIP EI MUST display the text: “CAL MISMATCH” and play a reorder tone to the user for a minimum of 3 seconds.

4.9.7 CAL Header Processing

4.9.7.1 INVITE

SIP-002970 When an AS-SIP signaling appliance (i.e., SS or SC) receives an initial INVITE with a CAL header from another SC or SS¹³ then the AS-SIP signaling appliance that receives the INVITE MUST process the CAL header as follows:

SIP-002970.a If the value of the access-mode field is “fixed” then:

STEP	INSTRUCTION
1	Using a SAL map table or equivalent, the value of the access-level field of the local-access-level in the CAL header is resolved against the locally configured access value for the routing domain over which the INVITE will travel to reach the next SC or SS or IP EI.
2	If the value of the access-level field is NOT supported by the locally configured access value for the routing domain of the next hop destination then the AS-SIP signaling appliance cannot provide the requested level of confidentiality and the AS-SIP signaling appliance MUST respond with a 418 Incompatible CAL; if the value of the access-level field of the local-access-level in the CAL header is supported when resolved against the locally configured access value for the routing domain over which the INVITE will travel next then the INVITE is forwarded to the next AS-SIP signaling appliance without any changes to the fields of the CAL header. ¹⁴

SIP-002970.b If the value of the access-mode field is “variable” then:

STEP	INSTRUCTION
1	Using a SAL map table or equivalent, the value of the access-level field of the local-access-level in the CAL header is resolved against the locally configured access value for the routing domain over which the INVITE will travel to reach the next SC or SS or IP EI.

¹³ It is noted that the INVITE will generally pass through 2 SBCs between an SC and a Softswitch or between a Softswitch and a Softswitch or between a Softswitch and a SC. The SBCs MUST NOT modify the CAL header.

¹⁴ See Requirement SIP-002980 for additional requirements regarding the CAL processing behavior of the terminating SC serving the intended recipient of the INVITE.

STEP	INSTRUCTION
2	If the value of the access-level field is NOT satisfactorily resolved to an acceptable level then the SC or SS MUST respond with a 418 Incompatible CAL; if the value of the access-level field is satisfactorily resolved against the locally configured access value for the routing domain of the next hop destination for the INVITE then the SC or SS MUST forward the INVITE onward with the resolved value for the access-level and mode placed in the local-access-level of the CAL header. ¹⁵

SIP-002980 When the terminating SC receives an INVITE with a CAL header intended for a served IP EI, then the terminating SC initially performs the same processing as set forth in Requirement SIP-002990 where the locally configured access value refers to the access level supported by the IP EI. If the IP EI either supports the value of the access-level in the local-access-level field of the CAL header (in the case of “fixed” mode) or if the terminating SC successfully resolves the value of the access-level in the local-access-level of the CAL header with the locally configured access value for the IP EI (in the case of “variable” mode) then the terminating SC conducts the following additional steps:

SIP-002980.a In the event the IP EI is not an AS-SIP EI the terminating SC MUST ensure that the IP EI displays the text corresponding to the final classification level as resolved by the terminating SC where the length of the text identifying the classification level is less than or equal to 16 characters.

SIP-002980.b In the event the IP EI is an AS-SIP EI the terminating SC MUST:

- Place the resolved access level and mode in the access-level and access-mode subfields respectively of the local-access-level of the CAL header.
- Generate the text corresponding to the resolved classification level and place the text in the access-display field of the CAL header.
- Send the INVITE with CAL header to the AS-SIP EI.

SIP-002980.b.1 The AS-SIP EI MUST display the text located in the access-display field to the user where the length of the text identifying the classification level is less than or equal to 16 characters.

4.9.7.2 Response

SIP-002990 When the terminating SC serving a called non-SIP, non-AS-SIP IP EI generates a 200 response to the initial INVITE on behalf of the served IP EI then the terminating SC MUST include the CAL Header in the 200 response where:

SIP-002990.a The terminating SC looks up the supported classification and mode for the served non-SIP, non-AS-SIP IP EI that is the intended recipient of the INVITE and MUST enter the supported classification and mode for the IP EI in the local-access-level of the CAL header in the 200 response.

¹⁵ See Requirement SIP-002980 for additional requirements regarding the CAL processing behavior of the terminating SC serving the intended recipient of the INVITE.

SIP-002990.b The terminating SC MUST place the final resolved classification value from the final SAL map table look-up or equivalent that was performed by the terminating SC on the INVITE and the final mode value into the access-level and reflected-mode subfields respectively of the reflected-access-level of the CAL header.

SIP-002990.c The terminating SC MUST place the text corresponding to the value of the access-level in the reflected-access-level field into the access-display field of the CAL header.

SIP-003000 When the terminating SC receives a 200 response to an INVITE with CAL header from a served SIP EI or AS-SIP EI then the terminating SC MUST generate a CAL Header for the 200 response where:

SIP-003000.a The terminating SC MUST look up the supported classification and mode for the served SIP EI or AS-SIP EI that was the recipient of the INVITE and MUST enter the configured classification and mode in the access level and access-mode subfields respectively of the local-access-level of the CAL header.

SIP-003000.b The terminating SC MUST place the final resolved classification value from the final SAL map table look-up or equivalent that was performed by the terminating SC on the INVITE and the final mode value into the access-level and reflected-mode subfields of the reflected-access-level of the CAL header.

SIP-003000.c The terminating SC MUST place the text corresponding to the value of the access-level in the reflected-access-level field into the access-display field of the CAL header.

NOTE: If the 200 response received by the terminating SC from the SIP EI or AS-SIP EI has a CAL header the received CAL header is removed and replaced by the new CAL header generated by the terminating SC.

SIP-003010 When an AS-SIP signaling appliance (i.e., SS or SC) receives a 200 response with a CAL header from another SC or SS then the AS-SIP signaling appliance that receives the 200 (OK) response MUST process the CAL header as follows:

SIP-003010.a If the value of the access-mode field is “fixed,” then:

STEP	INSTRUCTION
1	Using a SAL map table or equivalent, the value of the access-level subfield of the local-access-level in the CAL header is resolved against the locally configured access value for the routing domain over which the 200 response will travel to reach the next SC or SS or IP EI in the response path.

STEP	INSTRUCTION
2	If the value of the access-level subfield is NOT supported by the locally configured access value for the routing domain of the next hop destination then the AS-SIP signaling appliance MUST set the value of the access-level subfield in the local-access-level field to 0 (this signifies that the CAL could not be resolved to an acceptable level in the response path); if the value of the access-level subfield of the local-access-level in the CAL header is supported when resolved against the locally configured access value for the routing domain over which the 200 response will travel next then the 200 response is forwarded to the next AS-SIP signaling appliance in the response path without any changes to the fields of the CAL header ¹⁶ .

SIP-003010.b If the value of the access-mode field is “variable,” then:

STEP	INSTRUCTION
1	Using a SAL map table or equivalent, the value of the access-level subfield of the local-access-level in the CAL header is resolved against the locally configured access value for the routing domain over which the 200 response will travel to reach the next SC or SS or IP EI in the response path.
2	If the value of the access-level field is NOT satisfactorily resolved to an acceptable level then the SC or SS MUST set the value of the access-level subfield in the local-access-level to 0 (this signifies that the CAL could not be resolved to an acceptable level in the response path); if the value of the access-level subfield is satisfactorily resolved against the locally configured access value for the routing domain of the next hop destination for the 200 response, then the SC or SS MUST forward the 200 response onward in the response path with the resolved value for the access-level and mode subfields placed in the local-access-level of the CAL header. ¹⁷

SIP-003020 When the originating SC receives a 200 response with a CAL header intended for a served IP EI then the originating SC initially performs the same processing as set forth in Requirement SIP-003010 where the locally configured access value refers to the access level supported by the served IP EI.

SIP-003020.a In the event the IP EI is not an AS-SIP EI the originating SC MUST ensure that the IP EI displays the text corresponding to the final classification level in the reflected-access-level field where the length of the text identifying the classification level MAY be less than or equal to 16 characters.

SIP-003020.b In the event the IP EI is an AS-SIP EI the originating SC MUST do the following:

- Confirm that the access-display field has the correct text to represent the value of the access-level in the reflected-access-level field and, if the text in the access-display field received CAL header is not correct, then overwrite it with the correct text.
- Send the 200 response with CAL header to the AS-SIP EI.

SIP-003020.b.1 The AS-SIP EI MUST display the text located in the access-display field to the user.

¹⁶ See Requirement SIP-003020 for additional requirements regarding the CAL processing behavior of the originating SC serving the intended recipient of the 200.

¹⁷ See Requirement SIP-003020 for additional requirements regarding the CAL processing behavior of the originating SC serving the intended recipient of the 200.

4.9.8 Example of CAL Header Traversing the Signaling Path

Figure 4.9-1, Example of CAL Session Establishment using Variable Mode, provides an example of a CAL session establishment using the variable mode.

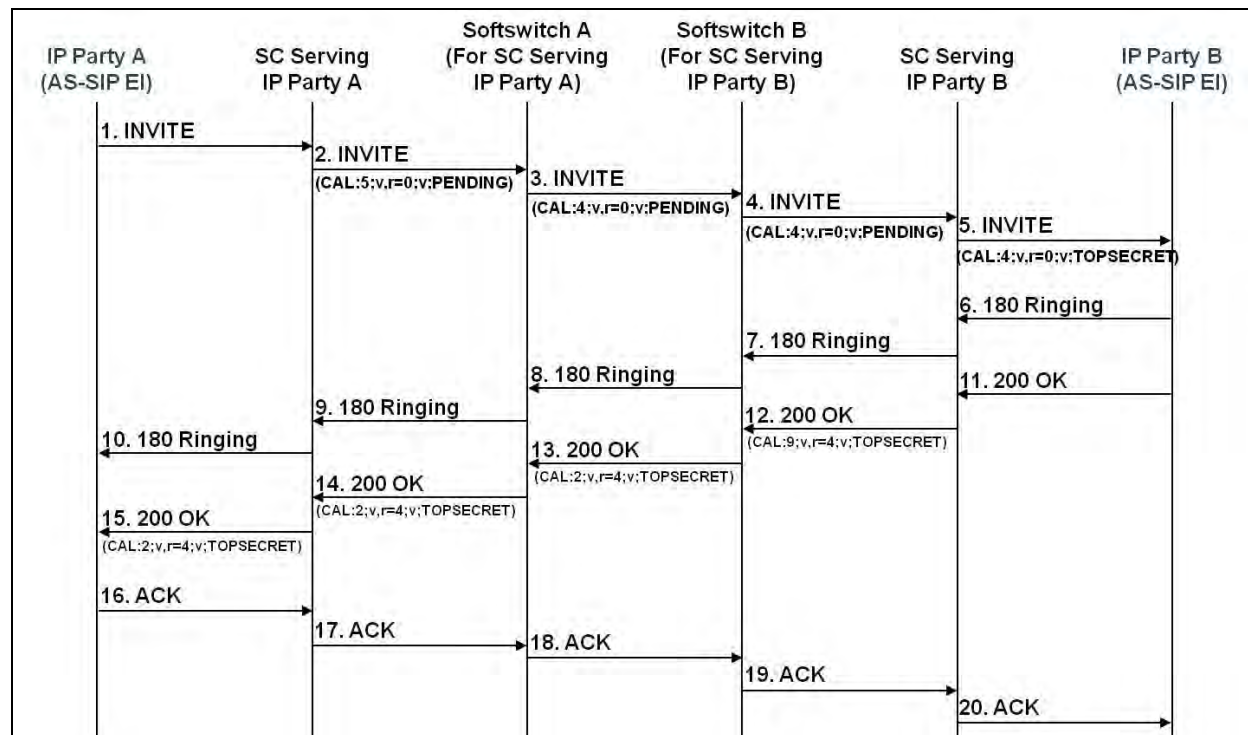

Figure 4.9-1. Example of CAL Session Establishment Using Variable Mode

STEP	INSTRUCTION
1	AS-SIP EI (IP Party A) sends initial INVITE without a CAL header to the originating SC (SC Serving IP Party A).
2-4	Originating SC looks up the confidentiality level and mode for the INVITE request from IP Party A. Originating SC checks that the directory number in the userinfo part of the SIP URI of the From header is valid for IP Party A and for the IP EI that sent the INVITE. If so, the originating SC generates a CAL header with the appropriate values for the local-access-level field. In this example, the access-level is 5 and the mode is variable. Since the INVITE has not reached the terminating SC, the access-display field has the text: PENDING. Confidential-Access-Level: 5;mode=variable;ref=0,rmode=variable;PENDING.
3	Softswitch A receives the INVITE from the originating SC and uses the value of the access-level in the CAL header (i.e., 5) and its locally configured value for the routing domain to SS B as inputs into its SAL map to resolve the value for the access-level that will be placed in the CAL header of the INVITE sent to SS B (i.e., 4). Confidential-Access-Level: 4;mode=variable;ref=0,rmode=variable;PENDING.
4	Softswitch B receives the INVITE from SS A and uses the value of the access-level in the CAL header (i.e., 4) and its locally configured value for the routing domain to SS B as inputs into its SAL map to resolve the value for the access-level that will be placed in the CAL header of the INVITE sent to SC Serving IP Party B (terminating SC) (i.e., 4).

STEP	INSTRUCTION
	Confidential-Access-Level: 4;mode=variable;ref=0,rmode=variable;PENDING.
	NOTE: For purposes of completeness: If the locally configured mode for the routing domain to SS B had been “fixed,” then assuming the confidentiality level supported by the next hop destination matched the value in the access-level subfield of the local-access-level in the received CAL header, then the new CAL header forwarded to the terminating SC would have an access-mode subfield whose value is “fixed.”
	Confidential-Access-Level: 4;mode=fixed;ref=0,rmode=fixed;PENDING.
5	The terminating SC receives the INVITE from SS B and uses the value of the access-level in the CAL header (i.e., 4) and its locally configured value for the AS-SIP EI (IP Party B) as inputs into its SAL map to resolve the value for the access-level that will be placed in the CAL header of the INVITE sent to IP Party B (i.e., 4). Let us say the value 4 corresponds to TOP SECRET, so the terminating SC also replaces the text PENDING in the access-display field with TOP SECRET. When the AS-SIP EI (IP Party B) receives the INVITE the AS-SIP EI displays the text TOP SECRET to the user.
	Confidential-Access-Level: 4;mode=variable;ref=0,rmode=variable;TOP SECRET.
6–10	AS-SIP EI (IP Party B) sends a 180 (Ringing) that is forwarded across the network to AS-SIP EI (IP Party A).
11	The AS-SIP EI (IP Party B) sends a 200 (OK) response without a CAL header to the terminating SC.
12	The terminating SC generates the CAL header, places the final resolved access level and mode from the CAL resolution process on the INVITE (Step 5) into the reflected-access-level (i.e., 4, variable), places the supported access level and mode of IP Party B at AS-SIP EI B into the local-access-level (i.e., 9, variable), and places the text for the resolved confidentiality level into the access-display field. The terminating SC forwards the 200 response with CAL header to SS B.
	Confidential-Access-Level: 9;mode=variable;ref=4,rmode=variable;TOP SECRET.
13	Softswitch B receives the 200 OK from the terminating SC and uses the value of the access-level subfield in the local-access-level in the CAL header (i.e., 9) and its locally configured value for the routing domain to SS A as inputs into its SAL map to resolve the value for the access-level subfield in the local-access-level field that will be placed in the CAL header of the 200 OK sent to SS A – (i.e., 2).
	Confidential-Access-Level: 2;mode=variable;ref=4,rmode=variable;TOP SECRET.
14	Softswitch A receives the 200 OK from SS B and uses the value of the access-level in the local-access-level field in the CAL header (i.e., 2) and its locally configured value for the routing domain to the originating SC (SC Serving IP Party A) as inputs into its SAL map to resolve the value for the access-level subfield in the local-access-level that will be placed in the CAL header of the 200 OK sent to the originating SC – (i.e., 2).
	Confidential-Access-Level: 2;mode=variable;ref=4,rmode=variable;TOP SECRET.
15	The originating SC receives the 200 OK from SS A and uses the value of the access-level subfield in the local-access-level in the CAL header (i.e., 2) and its locally configured value for the AS-SIP EI (IP Party A) as inputs into its SAL map to resolve the value for the access-level subfield in the local-access-level that will be placed in the CAL header of the 200 OK sent to IP Party A (i.e., 2). When the AS-SIP EI (IP Party A) receives the 200 OK the AS-SIP EI displays the text TOP SECRET to the user.
	Confidential-Access-Level: 2;mode=variable;ref=4,rmode=variable;TOP SECRET.
16–20	AS-SIP EI (IP Party A) sends an ACK that is forwarded across the network to AS-SIP EI (IP Party B).

4.10 SESSION KEEP-ALIVE TIMER

The purpose of the SIP Session Keep-Alive Timer paragraphs is to actively signal call termination where at least one EI is no longer partaking in the session.

4.10.1 AS-SIP Signaling Appliances

SIP-003030 The AS-SIP signaling appliances **MUST** support the keep-alive mechanism for SIP sessions (RFC 4028).

SIP-003040 The AS-SIP signaling appliances **MUST** support the generating, receiving, and processing of the Session-Expires and Min-SE header fields. The **RECOMMENDED** value for the Session-Expires header field is 1800. The value for the Min-SE header field **MUST** be greater than 90 (RFC 4028).

SIP-003050 The AS-SIP signaling appliances **MUST** support the 422 (Session Interval Too Small) response code (RFC 4028).

SIP-003060 The AS-SIP signaling appliances **MUST** support the option tag “timer” for use with the Supported and Require header fields; however, an AS-SIP signaling appliance acting as a UAC or a SIP EI acting as a UAC **MUST NOT** place the option tag “timer” in either a Require header or a Proxy-Require header (RFC 4028).

SIP-003070 The AS-SIP signaling appliances **SHOULD** use the UPDATE method (as opposed to the INVITE method) to perform subsequent session refreshes to minimize the processing impact.

SIP-003080 The UPDATE method used to perform subsequent session refreshes **SHOULD NOT** include an SDP offer to minimize the processing impact.

SIP-003090 When an AS-SIP signaling appliance receives an outbound request from a served H.323 or proprietary IP EI, then the AS-SIP signaling appliance **MUST** operate IAW the UAC behavior (when responsible for performing the refresh) (RFC 4028, Sections 7.1, Generating an Initial Session Refresh Request; 7.2, Processing a 2xx Response; 7.3, Processing a 422 Response; 7.4, Generating Subsequent Session Refresh Requests; and 10, Performing Refreshes).

SIP-003100 When an AS-SIP signaling appliance receives an outbound request from a served SIP EI, then:

SIP-003100.a If the SIP EI supports the keep-alive mechanism (RFC 4028), the AS-SIP signaling appliance **MUST** operate IAW the proxy behavior.

(RFC 4028, Section 8, Proxy Behavior) The AS-SIP signaling appliance **MUST** meet the requirements set forth in RFC 4028 (RFC 4028, Sections 8.1, Processing of Requests; 8.2, Processing of Responses; and 8.3, Session Expiration).

SIP-003100.b If the SIP EI does NOT support the keep-alive mechanism [RFC 4028], the AS-SIP signaling appliance MUST operate IAW the UAC behavior (when responsible for performing the refresh) (RFC 4028, Sections 7.1, Generating an Initial Session Refresh Request; 7.2, Processing a 2xx Response; 7.3, Processing a 422 Response; 7.4, Generating Subsequent Session Refresh Requests; and 10, Performing Refreshes).

SIP-003110 When an AS-SIP signaling appliance receives a call request from another AS-SIP signaling appliance and the destination is a served H.323 or proprietary IP EI, then the AS-SIP signaling appliance MUST operate IAW the UAS behavior (when responsible for performing the refresh) (RFC 4028 Sections 9, UAS Behavior, and 10, Performing Refreshes).

SIP-003120 When an AS-SIP signaling appliance receives a call request from another AS-SIP signaling appliance, and the destination is a served SIP EI, then:

SIP-003120.a If the SIP EI supports the keep-alive mechanism (RFC 4028), the AS-SIP signaling appliance MUST operate IAW the proxy behavior set forth in RFC 4028. [RFC 4028, Section 8, Proxy Behavior] The AS-SIP signaling appliance MUST meet the requirements set forth in RFC 4028 (RFC 4028, Sections 8.1, Processing of Requests; 8.2, Processing of Responses; and 8.3, Session Expiration).

SIP-003120.b If the SIP EI does NOT support the keep-alive mechanism (RFC 4028), the AS-SIP signaling appliance MUST operate IAW the UAS behavior (when responsible for performing the refresh) (RFC 4028, Sections 9, UAS Behavior, and 10, Performing Refreshes).

NOTE: The AS-SIP signaling appliance serving a SIP EI is charged with knowing whether the SIP EI supports the RFC 4028 session timer. It is assumed that the AS-SIP signaling appliance acquires this information as part of the SIP EI registration process or by configuration. In the alternative, the AS-SIP signaling appliance may obtain this information by other means such as by sending an INVITE with the Require header and the option tag “timer” to the SIP EI, which will reply with either a Supported header with the option tag “timer,” or a 420 (Bad Extension) response and an Unsupported header with the option tag “timer.”

4.10.2 AS-SIP EIs

SIP-003130 The AS-SIP EIs MUST support the keep-alive mechanism for SIP sessions (RFC 4028).

SIP-003140 The AS-SIP EIs MUST support the generating, receiving, and processing of the Session-Expires and Min-SE header fields. The RECOMMENDED value for the Session-Expires header field is 1800. The value for the Min-SE header field MUST be greater than 90 (RFC 4028).

SIP-003150 The AS-SIP EIs **MUST** support the 422 (Session Interval Too Small) response code (RFC 4028).

SIP-003160 The AS-SIP EIs **MUST** support the option tag “timer” for use with the Supported and Require header fields; however, an AS-SIP EI **MUST NOT** place the option tag “timer” in either a Require header or a Proxy-Require header (RFC 4028).

SIP-003170 The AS-SIP EIs **SHOULD** use the UPDATE method (as opposed to the INVITE method) to perform subsequent session refreshes to minimize the processing impact.

SIP-003180 The UPDATE method used to perform subsequent session refreshes **SHOULD NOT** include an SDP offer to minimize the processing impact.

SIP-003190 The AS-SIP EI **MUST** operate IAW the UAC behavior (when responsible for performing the refresh) (RFC 4028, Sections 7.1, Generating an Initial Session Refresh Request; 7.2, Processing a 2xx Response; 7.3, Processing a 422 Response; 7.4, Generating Subsequent Session Refresh Requests; and 10, Performing Refreshes).

SIP-003200 When an AS-SIP EIs receives an INVITE, then the AS-SIP EIs **MUST** operate IAW the UAS behavior (when responsible for performing the refresh) (RFC 4028 Sections 9, UAS Behavior, and 10, Performing Refreshes).

SECTION 5 SESSION DESCRIPTION PROTOCOL

5.1 SESSION DESCRIPTION

SIP-003210 “An SDP session description consists of a session-level section followed by zero or more media-level sections” (RFC 4566, Section 5, SDP Specification).

SIP-003220 When SDP information is present in a SIP message, the SIP message MUST have a content-type header having the MIME Content-Type “application/sdp.”

Content-Type: application/sdp

SIP-003230 The SDP parser in the AS-SIP signaling appliance (and all AS-SIP EIs, including AS-SIP video conferencing EIs) MUST be able to accept and handle without error any of the SDP line types enumerated in RFC 4566 even if the application ignores the contents (RFC 4566, Section 5, SDP Specification).

SIP-003240 The sdp parser in the intermediate AS-SIP signaling appliances (i.e., excluding the terminating SC if it is serving an IP EI, excluding the destination AS-SIP EI or SIP EI, excluding the SC or SS that is interworking the AS-SIP signaling message to the TDM network) MUST ignore a “type” letter that it does not understand and forward the sdp description as usual.

SIP-003240.a The terminating SC serving an IP EI “MUST completely ignore any session description that contains a type letter that it does not understand” (RFC 4566, section 5).

SIP-003240.b The AS-SIP EI or SIP EI “MUST completely ignore any session description that contains a type letter that it does not understand” (RFC 4566, Section 5).

SIP-003240.c The SC or SS that is interworking AS-SIP signaling to the TDM network “MUST completely ignore any session description that contains a type letter that it does not understand” (RFC 4566, Section 5).

SIP-003250 The session-level description of the SDP session description MUST include the following four mandatory line types and MUST appear in the following order: (RFC 4566)

v=
o=
s=
t=

NOTE: When any of the optional line types are included in the session level section of the session description, they MUST also be placed IAW the relative ordering defined in RFC 4566.

SIP-003260 Use of the “p=” or “e=” line type in the session-level description is optional.
[RFC 4566]

SIP-003270 The session-level section of the session description is followed by zero or more media-level sections. Each media-level description starts with an “m=” line, and is terminated by either the next “m=” line or by the end of the session description. An individual media description may have any number of attributes (“a=” fields), which are media specific.
[RFC 4566]

SIP-003280 The connection (“c=”) line MAY be placed at the session-level description, the media-level description, or both description levels (RFC 4566).

SIP-003290 When the connection (“c=”) line is placed in the session-level description, it applies to all media of the session unless overridden by connection information in the media-level description (RFC 4566).

SIP-003300 If the connection (“c=”) line is not present in the session-level description, then it MUST be present in each media-level description in the SDP session description (RFC 4566).

SIP-003310 The attribute mechanism (“a=”) is optional and MAY be placed at the session-level description, the media-level description, or both description levels (RFC 4566).

SIP-003320 When the attribute mechanism (“a=”) is placed in the session-level description, it applies to all media of the session unless overridden by attribute information of the same name in the media-level description (RFC 4566).

5.2 SESSION-LEVEL DESCRIPTION

SIP-003330 The session-level description consists of a protocol version line, an origin line, a session name line, and a time line.

5.2.1 Protocol Version (“v=”) Line

v=0

SIP-003340 SIP-003260/.3.4.9.2.1.1 The “v=” line MUST be set to zero.

5.2.2 Origin (“o=”) Line

o=<username> <session id> <sess-version> <network type> <address type>
<address>

SIP-003350 The <username> MUST NOT contain spaces and can be set to “-.”

SIP-003360 The numeric value of the <session id> MUST be representable with a 64-bit signed integer (RFC 3264, Section 5, Generating the Initial Offer).

SIP-003370 The <session id> SHOULD be set to a Network Time Protocol (NTP) timestamp in integer format, reflecting the time of the original creation of the session description (RFC 4566, Section 5, SDP Specification).

SIP-003380 The numeric value of the <sess-version> in the origin (“o=”) line MUST be representable with a 64-bit signed integer (RFC 3264, Section 5, Generating the Initial Offer).

SIP-003390 “The initial value of the version MUST be less than $(2^{62})-1$, to avoid rollovers” (RFC 3264, Section 5, Generating the Initial Offer).

SIP-003400 The <sess-version> SHOULD be set to an NTP timestamp in integer format (RFC 4566, Section 5, SDP Specification).

SIP-003410 Every time a modification is made to the session data, the <sess-version> MUST be incremented by one (RFC 4566, Section 5, SDP Specification).

SIP-003420 The <network type>, <address type>, and <address> SHOULD identify the SIP host that originates the session description, even if the description relates to a different host (e.g., an MG). Following this convention avoids having to change the originator value if the media flows are redirected. A consequence of this recommendation is that there is no necessary relationship between the host identification on the origin (“o=”) line and addresses given on a connection (“c=”) line.

SIP-003430 The first offer sent in a SIP session is an original session description, originated at the offering end. If the answer is otherwise the same as the offer (including the addressing information), RFC 3264, Section 6, says that the origin (“o=”) line can remain identical also. This is an unlikely circumstance. In the more usual case, the answer has different addresses at least reflecting that end of the media flow. An initial answer that is different from an initial offer MUST be viewed as an original session description, originated by the answering end. This means that the answer MUST contain a new origin (“o=”) line, constructed from the point of view of the answering SIP host (RFC 3264, Section 6, Generating the Answer).

SIP-003440 After the initial offer-to-answer exchange, if either end passes a session description to the other (whether in an offer or an answer) that is unchanged from what it last sent, the origin (“o=”) line MUST be the same as previously sent. If there is any change, RFC 3264 requires that the <version> MUST be incremented by one while the rest of the origin (“o=”) line remains unchanged (RFC 3264, Section 8, Modifying the Session).

5.2.3 Session Name (“s=”) Line

s= -

SIP-003450 The session name (“s=”) line SHOULD be set to “-” (RFC 3264, Section 5, Generating the Initial Offer).

5.2.4 Time (“t=”) Line

t=0 0

SIP-003460 The time (“t=”) line SHOULD be set to “0 0” (RFC 3264, Section 5, Generating the Initial Offer).

5.2.5 Clarification on the Use of ANAT for Related Media Streams

Compliance with the RFC 4091 Alternative Network Address Type (ANAT) attribute for the SDP grouping framework is a requirement set forth in UCR 2013 Section 5 IPv6 Requirement IP6-000400.

In this clarification, a simple approach for negotiating a common network address type for related media streams using the ANAT semantics is brought to the reader’s attention.

As a general rule, related media streams will use a common network address type.¹⁸ For example, in the case of a video session comprised of an audio stream and a video stream, the general expectation is that the RTP/UDP payloads of both media streams will be transported over either IPv4 packets or IPv6 packets, as opposed to having one media stream transported over IPv4 packets and the other media stream transported over IPv6 packets.

In the sdp offer, the offeror includes an a=group:ANAT line for each of the related media streams in which the same relative ordering of network address types is specified for each related media stream. (For example, in the case of a video session comprised of one audio stream and one video stream, the sdp offer would include an a=group:ANAT line for the audio stream and an a=group:ANAT line for the video stream whereby the relative ordering of IPv4 and IPv6 for the ANAT line for the audio stream matches the relative ordering of IPv4 and IPv6 for the ANAT line for the video stream.)

Noting that RFC 4091 Sec. 5 states “An answerer receiving a session description that uses the ANAT semantics SHOULD use the address with the highest priority it understands and set the ports of the rest of the ‘m’ lines of the group to zero”, the answerer SHOULD respond with an sdp answer having identical orderings of network address types for the related media streams.

In this way a common network address type is negotiated for the related media streams.

There may be instances in which the offeror or answerer device either is incapable of supporting a common network address type or is subject to a policy rule that results in a strong preference for different network address types for different related media streams.¹⁹

¹⁸ We do not preclude the possibility of a circumstance in which related media streams may use different network address types.

¹⁹ Please note that per RFC 3388 sec. 8.2, " "a=group" lines MUST NOT contain identification-tags that correspond to "m" lines with port zero." Therefore when the sdp answer includes one or more 'm' lines set to zero then the identification-tag associated with each 'm' line whose port is set to zero MUST NOT appear in an "a=group" line.

In such an instance, an offeror would not employ the a=group:ANAT line construction as described above and an answerer that receives a=group:ANAT lines will select different network address types for the different related media streams.

Example:

Here is an example of a video session offer in which an offeror uses a pair of 'a=group:ANAT' lines to notify the destination EI that the preferred network address type for both the audio and video streams is IPv6:

```
v=0
o=...
s=...
t=0 0
a=group:ANAT 1 3
a=group:ANAT 2 4

m=audio 3422 RTP/SAVP 0
c=IN IP6 FF1E:03AD::7F2E:172A:1E24
a=rtpmap:0 PCMU/8000
a=mid:1

m=video 49180 RTP/SAVP 109
c=IN IP6 FF1E:03AD::7F2E:172A:1E24
b=TIAS:320000
a=rtpmap:109 H264/90000
a=mid:2

m=audio 3444 RTP/SAVP 0
c=IN IP4 192.168.100.146
a=rtpmap:0 PCMU/8000
a=mid:3

m=video 48802 RTP/SAVP 109
c=IN IP4 192.168.100.146
b=TIAS:320000
a=rtpmap:109 H264/90000
a=mid:4
```

The destination EI honors the preferred relative ordering of network address types in the sdp offer by setting the port numbers of the m lines whose streams have IPv4 addresses to zero in the sdp answer:

```
v=0
o=...
s=...
```

```
t=0 0

a=group:ANAT 1
a=group:ANAT 2
m=audio 14000 RTP/SAVP 0
c=IN IP6 FF1E:03AD::7F2E:172A:1E24
a=rtpmap:0 PCMU/8000
a=mid:1

m=video 34282 RTP/SAVP 109
c=IN IP6 FF1E:03AD::7F2E:172A:1E24
b=TIAS:320000
a=rtpmap:109 H264/90000
a=mid:2

m=audio 0 RTP/SAVP 0
c=IN IP4 192.168.100.146
a=rtpmap:0 PCMU/8000
a=mid:3

m=video 0 RTP/SAVP 109
c=IN IP4 192.168.100.146
b=TIAS:320000
a=rtpmap:109 H264/90000
a=mid:4
```

5.3 MEDIA DESCRIPTION

SIP-003470 The media description consists of one or more media (“m=”) fields and subfields.

5.3.1 Media (“m=”) Field

```
m=<media> <port> <protocol> <format>
```

SIP-003480 A session description MAY contain a number of media descriptions.

SIP-003490 Each media description starts with an “m=” field and is terminated by the next “m=” field, or by the end of the session description. A media field has subfields.

SIP-003490.a The first subfield <media> is the media type (e.g., audio and video) (RFC 4566, Section 5, SDP Specification).

SIP-003490.b The second subfield <port> is the transport port to which the media stream is sent (RFC 4566, Section 5, SDP Specification).

SIP-003490.c The third subfield <protocol> is the transport protocol. For example, RTP-Audio-Visual Profile (AVP) denotes RTP used under the RTP Profile for Audio and Video Conferences (RFC 4566, Section 5, SDP Specification).

SIP-003490.d The fourth and subsequent subfields <format> are a media format description (RFC 4566, Section 5, SDP Specification). For example,

m=audio 49170 RTP/AVP 0

5.3.2 Connection Data (“c=”) Field

c=<nettype> <addrtype> <connection-address>

SIP-003500 The first subfield <nettype> is the network type. Initially, this specification allows only “IN.” [RFC 4566, Section 5, SDP Specification]

SIP-003510 The second subfield <addrtype> is the address type. This specification supports the use of IPv4 (RFC 2327) or IPv6 (RFC 4566).

SIP-003520 The third subfield <connection-address> is the connection address (RFC 4566, Section 5, SDP Specification).

SIP-003530 When the <addrtype> is IPv4 and the <connection-address> is a unicast address, then the format of the connection address will use the standard IPv4 decimal dotted notation.

SIP-003530.a When the <addrtype> is IPv6 and the <connection-address> is a unicast address, then the format of the connection address will use standard IPv6 notation.

Examples:

IN IP6 2001:db8::2:1
IN IP6 ABCD:EF01:2345:6789:ABCD:EF01:2345:6789
IN IP6 1080::8:800:116.23.135.22

SIP-003540 The slash notation defined for multicast group addresses MUST NOT be used with unicast addresses (RFC 4566, Section 5, SDP Specification).

Example:

IN IP4 118.2.36.42

SIP-003550 Multiple addresses or connection (“c=”) lines MAY be specified in a media description (RFC 4566, Section 5, SDP Specification).

SIP-003560 Only one connection (“c=”) line is permitted at the session description level (RFC 4566, Section 5, SDP Specification).

5.3.3 Attributes (“a=”) Fields

a=

SIP-003570 “Attributes are the primary means for extending SDP. Attributes may be defined to be used as “session-level” attributes, “media-level” attributes, or both. A media description may have any number of attributes (“a=”) fields) which are media specific. These are referred to as “media-level” attributes and they add information about the media stream. Attribute fields can also be added before the first media field; these “session-level” attributes convey additional information that applies to the conference as a whole rather than to individual media;...” (RFC 4566, Section 5, SDP Specification).

SIP-003580 The SDP parser in the AS-SIP signaling appliance (and all AS-SIP EIs, including AS-SIP video conferencing EIs) MUST be able to accept and handle any attribute (“a=”) field without error, even if it does not recognize the attribute. An unrecognized attribute MUST be ignored rather than treated as an error case. If the unrecognized attribute was sent in an SDP offer, it MUST NOT appear in the answer.

SIP-003580.a In this specification, the following attributes are used:

a=recvonly
a=sendrecv
a=sendonly
a=rtcp:<port>
a=rtpmap:<payload type> <encoding name>/<clock rate> [/<encoding parameters>]
a=curr:<precondition-type> <status-type> <direction-tag>
a=des:<precondition-type> <strength-tag> <status-type> <direction-tag>
a=conf:<precondition-type> <status-type> <direction-tag>

SIP-003580.b The rtpmap attribute maps from an RTP payload type number (as used in an “m=”) line) to an encoding name denoting the payload format to be used.

Example 1: [RFC 4566]

m=audio 49232 RTP/AVP 98
a=rtpmap:98 L16/16000/2

Example 2: [RFC 4566]

m=audio 49230 RTP/AVP 96 97 98
a=rtpmap:96 L8/8000
a=rtpmap:97 L16/8000
a=rtpmap:98 L16/11025/2

SIP-003580.c The codec formats (as depicted in example 2 above) are listed in the order of preference from the most preferred codec to the least preferred codec.

SIP-003580.d The “a=curr,” “a=des,” and “a=conf” media level SDP attributes are used in conjunction with preconditions as defined in RFC 3312.

Example:

```
m=audio 20000 RTP/AVP 0
a=curr:qos local none
a=curr:qos remote none
a=des:qos mandatory local sendrecv
a=des:qos mandatory remote sendrecv
a=curr:qos e2e none
a=des:qos optional e2e sendrecv
```

SIP-003590 In this specification, the following attributes SHOULD be supported:

```
a=ptime:<packet time>
a=maxptime:<maximum packet time>
a=fmtp:<format> <format specific parameters>
```

SIP-003590.a The a=ptime:<packet time> attribute gives the length of time in milliseconds represented by the media in a packet (RFC 4566).

SIP-003590.b The a=maxptime:<maximum packet time> attribute provides the maximum amount of media that can be encapsulated in each packet, expressed in milliseconds (RFC 4566).

SIP-003590.c The a=fmtp:<format> <format specific parameters> attribute allows parameters, specific to a particular format, to be conveyed in a way that the SDP does not have to understand them.

5.3.4 Bandwidth (“b=”) Field

```
b=<bwtype>:<bandwidth>
```

SIP-003600 The bandwidth (“b=”) field denotes the proposed bandwidth to be used by the session or media.

SIP-003610 On the session level, the bandwidth (“b=”) field represents a total bandwidth figure for all media at all sites.

SIP-003620 On the media level, the bandwidth (“b=”) field is required for every video media (“m=”) line.

SIP-003630 On the media level, the bandwidth (“b=”) field is NOT required for audio media (“m=”) lines.

SIP-003640 When used in the session level, the <bwtype> subfield shall be Application-Specific Maximum (AS).

SIP-003650 When used in the media level, the <bwtype> subfield shall be Transport Independent Application-Specific (TIAS) (RFC 3890).

SIP-003660 The <bandwidth> subfield is interpreted as kilobits per second.

5.3.5 Bandwidth Modifier Application Rules

SIP-003670 When there are multiple audio codecs in a single “m=” line, the bandwidth modifier (“b=TIAS”) MAY be present and, if present, MUST reflect the largest bit rate that those codecs can support.

SIP-003680 When there are multiple audio codecs in a single “m=” line and it is necessary to indicate the bit rate for particular audio codecs then an “a=fmtp:” format attribute will be associated with each audio codec to indicate the applicable bit rate.

Example:

```
m=audio 15134 RTP/AVP 102 0 97 18
b=TIAS:64000
a=rtpmap:102 G7221/16000
a=fmtp:102 bitrate=32000
a=rtpmap:0 PCMU/8000
a=rtpmap:97 SIREN14/16000
a=fmtp:97 bitrate=24000
a=rtpmap:18 G729A/8000
```

NOTE: The audio codecs in this example are used for illustrative purposes only and the presence or absence of an audio codec has no implications about whether a given audio codec is required to be supported on the UC network.

SIP-003690 When there are multiple video codecs in a single “m=” line, the bandwidth modifier (“b=TIAS”) must be present. The bandwidth modifier must be set to the value equal to the user-selected bandwidth value or the lowest value of the video codec’s upper limits, depending on which one is smaller. For example, if the user selects to launch a 2 Mbps video call and the video codec is capable of receiving H.261/H.263 at 2 Mbps, and H.264 at 384 Kbps, then the bandwidth modifier (“b=TIAS”) value must be set at b=TIAS:384000.

SIP-003700 When there are multiple video codecs in a single “m=” line and it is necessary to indicate the bit rate for particular video codecs, then an “a=fmtp:” format attribute will be associated with each video codec to indicate the applicable bit rate.

SIP-003710 The following example is a video SDP using both kinds of bandwidth modifiers:

```
v=0
o=TestVideo 1627471320 0 IN IP4 192.168.100.146
s=-
c=IN IP4 192.168.100.146
b=AS:384
t=0 0
m=audio 49178 RTP/AVP 99 98 97 102 101 103 9 15 0 8 18
b=TIAS:64000
a=rtpmap:99 SIREN14/16000
a=fmtp:99 bitrate=48000
a=rtpmap:98 SIREN14/16000
a=fmtp:98 bitrate=32000
a=rtpmap:97 SIREN14/16000
a=fmtp:97 bitrate=24000
a=rtpmap:102 G7221/16000
a=fmtp:102 bitrate=32000
a=rtpmap:101 G7221/16000
a=fmtp:101 bitrate=24000
a=rtpmap:103 G7221/16000
a=fmtp:103 bitrate=16000
a=rtpmap:9 G722/8000
a=rtpmap:15 G728/8000
a=rtpmap:0 PCMU/8000
a=rtpmap:8 PCMA/8000
a=rtpmap:18 G729A/8000
m=video 49180 RTP/AVP 109 34 96 31
b=TIAS:320000
a=rtpmap:109 H264/90000
a=fmtp:109 profile-level-id=42800c;max-mbps=10000
a=rtpmap:34 H263/90000
a=rtpmap:96 H263-1998/90000
a=fmtp:96 SQCIF=1;QCIF=1;CIF=1;CIF4=2;F;J;T
a=rtpmap:31 H261/90000
a=fmtp:31 CIF=1;QCIF=1
```

5.4 SDP PARAMETERS FOR VIDEO CODECS

5.4.1 H.261 Codec Parameters

SIP-003720 The H.261 video SDP must meet the following formats:

SIP-003720.a The media name in the “m=” line of the SDP MUST be video.

SIP-003720.b The encoding name in the “a=rtpmap” line of the SDP MUST be H261.

SIP-003720.c The clock rate in the “a=rtpmap” line of the SDP MUST be 90000.

SIP-003720.d The SDP MUST use the fmp4 media format description line to specify optional parameters, such as CIF, QCIF, and D.

SIP-003720.d.1 The “fmp4” parameters for H.261 are as follows:

a=fmp4:xx H261_option

where xx is the RTP payload type number. It can be a static or dynamic payload number. The recommendation is to use the dynamic payload number.

SIP-003720.d.2 The syntax of H261_option is:

H261_option = *Size/ *Annex SP
Size = “QCIF” “=” “mpi ;/ “CIF” “=” mpi ;
mpi = 1*2DIGIT
Annex = “D” “=” noyes;
noyes = 0/ 1

SIP-003720.e The “Size” parameter specifies the supported picture size and the frame rate. Recommendation H.261 defines two resolutions: QCIF and CIF. The default value is QCIF.

SIP-003720.f The minimum picture interval (MPI) is an integer value (1..4) and it means the maximum picture frame rate is (29.97/MPI) frames/second. The definition of the MPI is according to the video codec specification. The default value is one.

SIP-003720.g The “CIF” parameter has the format of parameter=value. It describes the maximum supported frame rate for the CIF resolution. Permissible values are integer values 1 to 4, which correspond to a maximum rate of 29.97/the specified value.

SIP-003720.h The “QCIF” parameter has the format of parameter=value. It describes the maximum supported frame rate for the QCIF resolution. Permissible values are integer values 1 to 4, which correspond to a maximum rate of 29.97/the specified value.

SIP-003720.i Picture sizes and MPI: A terminal SHOULD announce only those picture sizes (with their MPIs) that it is willing to receive. For example, MPI=2 means that the maximum (decodable) picture rate per second is about 15. If the receiver does not specify the picture size/MPI optional parameter, then it SHOULD be ready to receive the QCIF resolution with MPI=1.

SIP-003720.j Support for still image graphics must be specified according to Recommendation H.261 Annex D. The default value is none. This option MUST NOT

appear unless the sender of the SDP message is able to decode this option. This option SHALL be considered as a receiver's capability even when sent in a sendonly offer.

SIP-003720.k An example of media representation in SDP (where CIF is 15 frames per second, QCIF is 30 frames per second, and Annex is D) is as follows:

```
m=video 49170/2 RTP/AVP 31
a=rtpmap:31 H261/90000
a=fmtp:31 CIF=2;QCIF=1;D
```

NOTE: 49170/2 indicates that there are two RTP/RTCP transport pairs: 49170 and 49171 comprise one RTP/RTCP pair, and 49172 and 49173 comprise the second RTP/RTCP pair.

5.4.2 H.263 Codec Parameters

SIP-003730 The video/H263-1998 and video/H263-2000 media types are mapped to fields in the SDP as follows:

SIP-003730.a The media name in the "m=" line of the SDP MUST be video.

SIP-003730.b The encoding name in the "a=rtpmap" line of the SDP MUST be H263-1998 or H263-2000.

SIP-003730.c The clock rate in the "a=rtpmap" line of the SDP MUST be 90000.

SIP-003730.d The SDP MUST use the fmtp media format description line to specify optional parameters.

SIP-003730.d.1 The "fmtp" parameters for H.263 are represented in the SDP attribute, as follows:

```
a=fmtp:xx H263_option
```

where the xx is the RTP payload type number. It can be a static or dynamic payload number. The recommendation is to use the dynamic payload number.

SIP-003730.d.2 When present, optional parameters take the form of optional parameter "="value where value may consist of a single field or of multiple comma delimited fields.

Example:

```
SQCIF=16
Custom=2000,1500,4
```

SIP-003730.d.3 When multiple optional parameters are present they are listed one after the other using a semicolon as the delimiter between optional parameters.

5.4.2.1 H.263-1998 Optional Parameters

SIP-003740 [Table 5.4-1](#) provides a list of H263-1998 optional parameters (left column) and the accompanying fields and their permissible values (right column).

Table 5.4-1. H263-1998 Optional Parameters and Their Permissible Values

OPTIONAL PARAMETER	PERMISSIBLE VALUES
SQCIF	1 field: MPI: permissible value – integer from 1 to 32
QCIF	1 field: MPI: permissible value – integer from 1 to 32
CIF	1 field: MPI: permissible value – integer from 1 to 32
CIF4	1 field: MPI: permissible value – integer from 1 to 32
CIF16	1 field: MPI: permissible value – integer from 1 to 32
Custom	Three comma-separated integer fields: Xmax, Ymax, MPI, where Xmax and Ymax must be divisible by four, and MPI is an integer value from 1 to 32.
F	If Annex F is supported, then “1,” or if not supported, then “0,” or not listed. It is recommended that an annex not be listed if it is not supported.
I	If Annex I is supported, then “1,” or if not supported, then “0,” or not listed. It is recommended that an annex not be listed if it is not supported.
J	If Annex J is supported, then “1,” or if not supported, then “0,” or not listed. It is recommended that an annex not be listed if it is not supported.
K	Annex K: 1 field: permissible value – integer from 1 to 4 where 1 indicates Slices In Order, Non-Rectangular 2 indicates Slices In Order, Rectangular 3 indicates Slices Not Ordered, Non-Rectangular 4 indicates Slices Not Ordered, Rectangular
N	1 field: permissible value – integer from 1 to 4 where: 1. NEITHER: No back-channel data is returned from the decoder to the encoder. 2. ACK: The decoder returns only acknowledgment messages. 3. NACK: The decoder returns only non-acknowledgment messages. 4. ACK+NACK: The decoder returns both acknowledgment and non-acknowledgment messages.
P	Four submodes with integer values from 1 to 4; multiple modes may be selected separated by commas where: 1 dynamicPictureResizingByFour 2 dynamicPictureResizingBySixteenthPel 3 dynamicWarpingHalfPel 4 dynamicWarpingSixteenthPel Example: P=1,3
PAR	Two colon-separated integers each between 0 and 255.

OPTIONAL PARAMETER	PERMISSIBLE VALUES
CPCF	Comma-separated list of eight parameters par1: cd: integer from 1 to 27 par2: cf: integer with value 1000 or 1001 par3: SQCIFMPI: integer from 0 to 2048 where 0 means associated picture size in unsupported and 1 to 2048 indicates the MPI par4: QCIFMPI: integer from 0 to 2048 where 0 means associated picture size in unsupported and 1 to 2048 indicates the MPI par5: CIFMPI: integer from 0 to 2048 where 0 means associated picture size in unsupported and 1 to 2048 indicates the MPI par6: CIF4MPI: integer from 0 to 2048 where 0 means associated picture size in unsupported and 1 to 2048 indicates the MPI par7: CIF16MPI: integer from 0 to 2048 where 0 means associated picture size in unsupported and 1 to 2048 indicates the MPI par8: CUSTOMMPI: integer from 0 to 2048 where 0 means associated picture size in unsupported and 1 to 2048 indicates the MPI; if not 0, then the “CUSTOM” parameter MUST also be present in sdp
BPP	Integer value between 0 and 65536 that is divisible by 1024; if not present, then the default value, based on the maximum supported resolution, is used.
HRD	If supported, then “1”; if not supported, then “0,” or not listed. It is recommended that the HRD not be listed if not supported.

Additional Details on H.263-1998 Optional Parameters

Picture Size Options

- SQCIF. Specifies the MPI for SQCIF resolution corresponding to maximum frame rate of $30/(1.001 * MPI)$ frames per second.
- QCIF. Specifies the MPI for QCIF resolution corresponding to maximum frame rate of $30/(1.001 * MPI)$ frames per second.
- CIF. Specifies the MPI for CIF resolution corresponding to maximum frame rate of $30/(1.001 * MPI)$ frames per second.
- CIF4. Specifies the MPI for 4CIF resolution corresponding to a maximum frame rate of $30/(1.001 * MPI)$ frames per second.
- CIF16. Specifies the MPI for 16CIF resolution corresponding to a maximum frame rate of $30/(1.001 * MPI)$ frames per second.
- CUSTOM. Specifies the MPI for a custom-defined resolution using Xmax to represent the number of pixels in the X axis, Ymax to represent the number of pixels in the Y axis, and MPI.

SIP-003750 When a video conferencing EI declares support of a specific MPI for one of the resolutions, the video conferencing EI MUST also implicitly support a lower resolution with the same MPI.

5.4.2.2 Support for Optional Annexes

SIP-003760 A video conferencing EI declares support for each of optional Annexes F, I, J, and T by including the annex letter in H263_option and setting the annex letter equal to one.

For example, when the offeror includes the sdp line: a=fmtp:98 F=1; J=1, then the offeror is declaring its support for optional Annex F and optional Annex J.

SIP-003770 When a video conferencing EI does not support an optional annex, it SHOULD NOT include the optional annex in the sdp. A video conference unit MAY also indicate nonsupport for an optional annex by setting the annex letter equal to 0.

For example, when the offeror includes the sdp line: a=fmtp:99 F=1; I=0; J=1, then the offeror is declaring its support for optional Annex F and optional Annex J, and lack of support for optional Annex I.

SIP-003780 A video conferencing EI declares support for optional Annex K by including K in H263_option and setting K equal to either 1, 2, 3, or 4 where:

- K=1 signifies Slices In Order, Non-Rectangular
- K=2 signifies Slices In Order, Rectangular
- K=3 signifies Slices Not Ordered, Non-Rectangular
- K=4 signifies Slices Not Ordered, Rectangular

SIP-003790 A video conferencing EI declares support for optional Annex N by including N in H263_option and setting N equal to either one, two, three, or four where

- N=1 signifies NEITHER: No back-channel data is returned from the decoder to the encoder.
- N=2 signifies ACK: The decoder returns only acknowledgment messages.
- N=3 NACK: The decoder returns only non-acknowledgment messages.
- N=4 ACK+NACK: The decoder returns both acknowledgment and non-acknowledgment messages.

SIP-003800 A video conferencing EI declares support for optional Annex P by including P in H263_option and setting P equal to at least one of 1, 2, 3, or 4 submodes where

- 1 signifies support for dynamicPictureResizingByFour
- 2 signifies support for dynamicPictureResizingBySixteenthPel
- 3 signifies support for dynamicWarpingHalfPel
- 4 signifies support for dynamicWarpingSixteenthPel

NOTE: P may be set to one submode, e.g., P=1 or to multiple submodes using the comma (“,”) as the delimiter: P=1,3.

SIP-003810 Codec options (F, I, J, K, N, P, T) MUST NOT appear in the sdp unless the sender of these “SDP” parameters is able to decode the given options.

NOTE: These options designate receiver capabilities even when sent in a sendonly offer.

5.4.2.3 Other Optional Parameters

SIP-003820 The PAR (Arbitrary Pixel Aspect Ratio) defines the width : height ratio by two colon-separated integers between 0 and 255, and when not otherwise specified the video conferencing EI MUST use the default ratio of 12:11.

SIP-003830 The CPCF (Arbitrary (Custom) Picture Clock Frequency) uses eight parameters to specify a custom picture clock frequency and the minimum picture interval for the supported picture sizes (i.e., “SQCIF,” “QCIF,” “CIF,” “4CIF,” “16CIF,” and “CUSTOM”). Parameter 1 (cd – an integer from 1 to 127) and parameter 2 (cf – assigned either the value 1000 or 10001) define the picture custom clock frequency IAW the formula $1800000/(cd*cf)$. The next six parameters (i.e., parameter 3–parameter 8) are “SQCIFMPI,” “QCIFMPI,” “CIFMPI,” “CIF4MPI,” “CIF16MPI,” and “CUSTOMMPI,” and each specifies an integer MPI for the standard picture sizes SQCIF, QCIF, CIF, 4CIF, 16CIF, and CUSTOM. The “MPI” parameter having a value in the range 1 to 2048 is used along with cd and cf to calculate a maximum frame rate using the formula $1800000/(cd*cf*MPI)$. If the MPI value equals zero, then the associated picture size is not supported for the custom picture clock frequency. If the “CUSTOMMPI” parameter is not equal to zero, then the “CUSTOM” parameter MUST also be present (to define the Xmax and Ymax dimensions of the custom picture size).

SIP-003840 BPP (BitsPerPictureMaxKb) has an integer value between 0 and 65536 that specifies the maximum number of bits in units of 1024 bits that the video conferencing EI allows to represent a single picture. If this parameter is not present, then the default value, based on the maximum supported resolution, MUST be used.

SIP-003850 If the “HRD” (Hypothetical Reference Decoder) parameter is supported, it MUST have the value “1,” and if not supported, it SHOULD NOT be listed, but if it is listed, it MUST have the value “0”.

SIP-003860 Video conferencing EIs MUST ignore optional parameters that are received in an sdp that are not recognized.

5.4.2.4 H.263-2000 Optional Parameters

SIP-003870 The H.263-2000 can be specified using one of two different SDP syntaxes.

- The H.263-2000 can apply the optional parameters of the H.263-1998 provided that PROFILE and LEVEL SHALL NOT be used.

- The H.263-2000 can apply the PROFILE and LEVEL as defined in the Annex X of H.263-2000, provided there is no use of H.263-1998 annex option values. Annex X of H.263-2000 defines profiles, which group annexes for specific applications.

SIP-003880 If the second SDP syntax is chosen (i.e., PROFILE and LEVEL per Annex X), the fmp must follow:

a=fmtp:xx H263-2000_option

(The xx is the RTP payload type number. It can be a static or dynamic payload number. The recommendation is to use the dynamic payload number.)

H263-2000_option = "PROFILE" "=" profile_value ;/ "LEVEL" "=" level_value
;/ "INTERLACE" "=" interface_value

SIP-003890 Specific optional parameters that may be used with the H.263-2000 type are:

SIP-003890.a The "profile_value" parameter is an H.263 profile number, in the range zero through ten. The "profile_value" parameter refers to the profile listed in table X.1 of H.263, Annex X, which specifies the supported H.263 annexes and subparts applicable to each profile.

NOTE: If no profile or H.263 annex is specified, then the stream is Baseline H.263 (profile 0 of H.263, Annex X).

SIP-003890.b The "level_value" parameter is the level of bit stream operation, in the range 0 through 100, specifying the level of computational complexity of the decoding process. A system that specifies support of a PROFILE MUST specify the supported LEVEL. See table X.1 of H.263, Annex X of ITU-T H.263 for details on the values of various parameters associated with each level.

SIP-003890.b.1 Support of any level other than level 45 implies support of all lower levels.

SIP-003890.b.2 Support of level 45 implies support of level 10.

SIP-003890.c The "interface_value" parameter is interlaced or 60 fields that indicate the support for interlace display mode (see H.263, Annex W, W.6.3.11). The "interface_value" parameter MUST have a value of one if it is supported and SHOULD NOT be listed if it is not supported or if listed MUST be assigned the value of zero.

SIP-003890.d When the "PROFILE" and "LEVEL" parameters are not specified, Baseline Profile (Profile 0) Level 10 are the default values. An example of H.263-2000 in the "PROFILE" and "LEVEL" parameters is as follows:

m = video 8398 RTP/AVP 107 104 116 117 118 119
a=rtpmap:107 h263-2000/90000

a=rtpmap:104 h263-2000/90000
a=rtpmap:116 h263-2000/90000
a=rtpmap:117 h263-2000/90000
a=rtpmap:118 h263-2000/90000
a=rtpmap:119 h263-2000/90000
a=fmtp:107 profile=3;level=10
a=fmtp:104 profile=3;level=40
a=fmtp:116 profile=0;level=40
a=fmtp:117 profile=0;level=30
a=fmtp:118 profile=0;level=20
a=fmtp:119 profile=0;level=10

5.4.2.5 H.263 SDP Offer Answer Rules

SIP-003900 An sdp offer MUST NOT include a “PROFILE” parameter unless the offeror is capable of decoding a stream that uses the specified “PROFILE” parameter.

SIP-003910 decoder that supports a profile MUST also support H.263 baseline profile (profile 0).

SIP-003920 It is RECOMMENDED that an offeror offer all the different profiles it is interested in using as individual payload types.

SIP-003930 It is RECOMMENDED that when an offeror creates an sdp offer having the “PROFILE” parameter that the sdp offer includes profile 0 also.

SIP-003940 An answerer MUST NOT change the “PROFILE” parameter and MUST reject the payload type containing an unsupported profile.

SIP-003950 The “LEVEL” parameter in an sdp offer MUST indicate the maximum computational complexity supported by the offeror in performing decoding for the given “PROFILE.”

SIP-003960 The sdp answer MAY change the “LEVEL” parameter up or down to reflect the maximum computational complexity supported by the answerer.

SIP-003970 The “Interlace” parameter MAY be included in either an offer or an answer to indicate that the offeror or answerer respectively supports reception of interlaced content.

SIP-003980 Video EIs MUST only offer picture sizes and their corresponding MPI information that the video EI is willing to receive.

NOTE: Parameters offered first are the most preferred picture mode to be received.

SIP-003990 A video EI that does not specify the picture size/MPI optional parameter SHOULD be ready to receive QCIF resolution with MPI=1.

5.4.3 H.264 Codec Parameters

SIP-004000 The MIME media type video/H264 string is mapped to fields in the SDP as follows:

SIP-004000.a The media name in the “m=” line of the SDP MUST be video.

SIP-004000.b The encoding name in the “a=rtpmap” line of the SDP MUST be H264 (the MIME subtype).

SIP-004000.c The clock rate in the “a=rtpmap” line of the SDP MUST be 90000.

SIP-004010 The AS-SIP signaling appliance must follow the requirements of RFC 6184 where it specifies the rules for applying H.264 parameters to the SDP offer/answer model (RFC 6184, Section 8.2.2, Usage with the SDP Offer/Answer Mode).

SIP-004020 The “fmt” parameters for H.264 are represented in the SDP attribute, as follows:

a=fmt:xx H264_option

where xx is the RTP dynamic payload number.

SIP-004030 The syntax of the OPTIONAL parameters of H264_option is

H264_option = *Params
Params=

```
/ “profile-level-id” “=” value ; / “max-mbps” “=” value; / “max-fs” “=” value;  
/ “max-cpb” “=” value ; / “max-dpb” “=” value ; / “max-br” “=” value ;  
/ “redundant-pic-cap” “=” value ; / “sprop-parameter-sets” “=” value ; / “parameter-add” “=” value ;  
/ “packetization-mode” “=” value ; / “sprop-nterleaving-depth” “=” / “deint-buf-cap” “=” value ;  
/ “sprop-deint-buf-req” “=” value ; / “sprop-init-buf-time” “=” value ; / “sprop-max-don-diff” “=” value ;  
/ “max-rcmd-nalu-size” “=” value
```

SIP-004040 The OPTIONAL parameters include “profile-level-id,” “max-mbps,” “max-fs,” “max-cpb,” “max-dpb,” “max-br,” “redundant-pic-cap,” “sprop-parameter-sets,” “parameter-add,” “packetization-mode,” “sprop-nterleaving-depth,” “deint-buf-cap,” “sprop-deint-buf-req,” “sprop-init-buf-time,” “sprop-max-don-diff,” and “max-rcmd-nalu-size.”

SIP-004040.a The OPTIONAL parameter “profile-level-id” indicates the profile that the codec supports and the highest level supported for the signaled profile. The “profile-

level-id” parameter is a 6-hexadecimal value representing three bytes of information in the sequence parameter set NAL unit:

- byte 1: the profile-idc (indicates the supported profile)
- byte 2: profile-iop, composed of the values of constraint_set0_flag, constraint_set1_flag, constraint_set2_flag, and reserved_zero_5bits in bit-significance order, starting from the most significant bit

NOTE: When the constraint_set0_flag = 1 value is used, then the bitstream obeys all constraints specified in H.264, Annex A, subclause A.2.1, Baseline Profile; when the constraint_set0_flag = 0 value is used, then the bitstream MAY or MAY NOT obey all constraints specified in H.264, Annex A, subclause A.2.1, Baseline Profile.

NOTE: When the constraint_set1_flag = 1 value is used, then the bitstream obeys all constraints specified in H.264, Annex A, subclause A.2.2, Main Profile; when the constraint_set1_flag = 0 value is used; then the bitstream MAY or MAY NOT obey all constraints specified in H.264, Annex A, subclause A.2.2, Main Profile.

NOTE: When the constraint_set2_flag = 1 value is used, then the bitstream obeys all constraints specified in H.264, Annex A, subclause A.2.3, Extended Profile; when the constraint_set2_flag = 0 is used, then the bitstream MAY or MAY NOT obey all constraints specified in H.264, Annex A, subclause A.2.3, Extended Profile.

NOTE: When profile_idc is equal to 100, 110, 122, or 144, the values of constraint_set0_flag, constraint_set1_flag, and constraint_set2_flag must all be equal to zero.

- byte 3: level-idc (indicates the highest level supported for the given profile)
 - SIP-004040.a.1** In the DoD environment there is an expectation that video EIs shall negotiate sessions that will provide end users with satisfactory video quality. To this end, the UCR requires that a video EI SHALL support level 1.2 or greater (where the MaxBR for level 1.2 is 384kbps) for each of the H.264 profiles supported by the video EI.
- When the video EI advertises H.264 in a sdp offer the video EI SHALL always include at least one codec profile (i.e., the H.264 offer SHALL include a payload type having at least one ‘a=fmtp:’ attribute with a profile-level-id parameter)²⁰.
- The value of the level_idc byte of the profile-level-id SHALL be configurable and the default configuration SHALL be a level of 1.2 or greater for all codec profiles in the H.264 offer (Please see the example in SIP-004210).

²⁰ Depending on the circumstances it may be necessary or desirable to include other optional parameters such as packetization-mode and sprop-parameter-sets

- It is recognized that in order to accommodate low bandwidth environments the default configuration (i.e., level 1.2 or greater) may be excessive and therefore it is a further requirement that the video EI have the capability to be configured so that the value of the level_idc byte of the profile-level-id in the codec profile(s) in the H.264 offer can be set to any level less than 1.2.

NOTE: If a profile-level-id is not present in the sdp offer then the video EI is NOT operating in compliance with the UCR, however, in conformance with RFC 6184 the absence of a profile-level-id implies support for the Baseline Profile without additional constraints at Level 1.

SIP-004040.b The OPTIONAL parameters “max-mbps,” “max-fs,” “max-cpb,” “max-dpb,” and “max-br” are used to signal the capabilities of a receiver implementation, and the “profile-level-id” parameter MUST be present in the same receiver capability description that contains any of these parameters. The receiver MUST be fully capable of supporting the level conveyed in the “profile-level-id” parameter and “max-mbps,” “max-fs,” “max-cpb,” “max-dpb,” and “max-br” parameters MAY be used to indicate capabilities of the receiver that extend the required capabilities of the signaled level in the “profile-level-id” parameter.

SIP-004040.b.1 If more than one of these OPTIONAL parameters is present in the sdp line, then the receiver MUST simultaneously support each of the OPTIONAL parameters present in the sdp line.

SIP-004040.b.2 The value of the “max-mbps” parameter is an integer indicating the maximum macroblock processing rate in units of macroblocks per second. The “max-mbps” parameter is used to indicate that the receiver is capable of decoding video at a higher rate than is required by the signaled level conveyed in the value of the “profile-level-id” parameter.

SIP-004040.b.3 The value of the “max-fs” parameter is an integer indicating the maximum frame size in units of macroblocks. The “max-fs” parameter is used to indicate that the receiver is capable of decoding larger picture sizes than are required by the signaled level conveyed in the value of the “profile-level-id” parameter.

SIP-004040.b.4 The value of the “max-cpb” parameter is an integer indicating the maximum coded picture buffer size in units of 1000 bits for the “VCL HRD” parameters (see ITU-T H.264, subclause A.3.1, item i) and in units of 1200 bits for the “NAL HRD” parameters. The “max-cpb” parameter is used to indicate that the receiver has more memory than the minimum amount of coded picture buffer memory required by the signaled level conveyed in the value of the “profile level id” parameter.

SIP-004040.b.5 The value of the “max-dpb” parameter is an integer indicating the maximum decoded picture buffer size in units of 1024 bytes. The “max-dpb” parameter is used to indicate that the receiver has more memory than the minimum amount of decoded picture buffer memory required by the signaled level conveyed in the value of the “profile-level-id” parameter.

SIP-004040.b.6 The value of the “max-br” parameter is an integer indicating the maximum video bit rate in units of 1000 bits per second for the “VCL HRD” parameters (see ITU-T H.264, subclause A.3.1, item i) and in units of 1200 bits per second for the “NAL HRD” parameters (see ITU-T H.264, subclause A.3.1, item j). The “max-br” parameter is used to indicate that the receiver is capable of decoding video at a higher bit rate than is required by the signaled level conveyed in the value of the “profile-level-id” parameter.

SIP-004040.c The OPTIONAL parameter “redundant-pic-cap” signals the capabilities of a receiver implementation. Setting the “redundant-pic-cap” parameter equal to zero indicates that the receiver does not attempt to use redundant coded pictures to correct incorrectly decoded primary coded pictures, and the receiver is not capable of using redundant slices. Setting the “redundant-pic-cap” parameter equal to one indicates the receiver is capable of decoding any such redundant slice that at least partly covers a corrupted area in a primary decoded picture. If the “redundant-pic-cap” parameter is not present, then it has the value of zero.

SIP-004040.d The OPTIONAL parameter “sprop-parameter-sets” MAY be used to convey any sequence and picture parameter set NAL units that MUST precede any other NAL units in decoding order. The value of the parameter is the base64 representation of the initial parameter set NAL units as specified in ITU-T H.264, Sections 7.3.2.1 and 7.3.2.2. The parameter sets are conveyed in decoding order, and no framing of the parameter set NAL units takes place. A comma is used to separate any pair of parameter sets in the list.

NOTE: The “sprop-parameter-sets” parameter MUST NOT be used to indicate codec capability in any capability exchange procedure.

SIP-004040.e The OPTIONAL parameter “parameter-add” MAY be used to signal whether the receiver of this parameter is allowed to add parameter sets in its signaling response using the “sprop-parameter-sets” MIME parameter. The value of this parameter is either zero, which means the receiver of the “parameter-add” parameter is not allowed to add parameter sets, or one, which means the receiver can add parameter sets. If this parameter is not present, then its value MUST be one.

SIP-004040.f The OPTIONAL parameter “packetization-mode” signals either the properties of an RTP payload type or the capabilities of a receiver implementation. Only a single RTP payload type can be indicated; thus, when capabilities to support more than

one packetization-mode are declared, multiple RTP payload types must be used. The value of packetization mode MUST be an integer in the range of zero to two, where zero signifies the use of single NAL mode (defined in RFC 6184, Section 6.2), one signifies the use of non-interleaved mode (defined in RFC 6184, Section 6.3), and two signifies the use of interleaved mode (defined in RFC 6184, Section 6.4). When this parameter is NOT present, then this signifies the use of single NAL mode (defined in RFC 6184, Section 6.2).

SIP-004040.g The value of OPTIONAL parameter “sprop-interleaving-depth” MUST be an integer in the range of 0 to 32767, inclusive, and specifies the maximum number of video coding layer (VCL) NAL units that precede any VCL NAL unit in the NAL unit stream in transmission order and follow the VCL NAL unit in decoding order. This parameter MUST NOT be present when packetization-mode is not present or when packetization-mode has the value of zero or one. This parameter MUST be present when the “packetization-mode” parameter has the value of two.

SIP-004040.h The OPTIONAL parameter “sprop-deint-buf-req” signals the required size of the deinterleaving buffer for the NAL unit stream. The value of the parameter MUST be greater than or equal to the maximum buffer occupancy, in bytes, required in such a deinterleaving buffer, specified in RFC 6184, Section 7.2. It is guaranteed that receivers can perform the deinterleaving of interleaved NAL units into NAL unit decoding order, when the deinterleaving buffer size is at least the value, in bytes, of “sprop-deint-buf-req” parameter. The value of “sprop-deint-buf-req” parameter MUST be an integer in the range of 0 to 4294967295, inclusive. This parameter MUST NOT be present when packetization-mode is not present or the value of packetization-mode is equal to zero or one. It MUST be present when the value of packetization-mode is equal to two.

SIP-004040.i The OPTIONAL parameter “deint-buf-cap” signals the capabilities of a receiver implementation and indicates the amount of deinterleaving buffer space, in bytes, that the receiver has available for reconstructing the NAL unit decoding order. The value of the “deint-buf-cap” parameter MUST be an integer in the range of 0 to 4294967295, inclusive. If it is not present, then a value of zero MUST be used for the “deint-buf-cap” parameter.

SIP-004040.j The OPTIONAL parameter “sprop-init-buf-time” signals the initial buffering time that a receiver MUST buffer before starting decoding to recover the NAL unit decoding order from the transmission order. The parameter is coded as a non-negative base10 integer representation in clock ticks of a 90-kHz clock and MUST be an integer in the range of 0 to 4294967295, inclusive. The parameter MUST NOT be present, if the value of packetization-mode is equal to zero or one. If the parameter is not present, then no initial buffering time value is defined.

SIP-004040.k The OPTIONAL parameter “sprop-max-don-diff” MAY be used to signal the properties of a NAL stream but not for a transmitter or receiver capability exchange.

The “sprop-max-don-diff” parameter is an integer in the range of 0 to 32767, inclusive, and it is calculated IAW a formula provided in RFC 6184, Section 8.1. (Please refer to RFC 6184, Section 8.1 for details). This parameter MUST NOT be present if the value of packetization-mode is equal to zero or one. If not present, then the value of the parameter is unspecified.

SIP-004040.1 The value of OPTIONAL parameter “max-rcmd-nalu-size” MUST be an integer in the range of 0 to 4294967295, inclusive, and indicates the largest Network Abstraction Layer Unit (NALU) size in bytes that the receiver can handle efficiently. If this parameter is not specified, then no known limitation to the NALU size exists.

5.4.3.1 SDP Offer/Answer Rules for H.264 Optional Parameters

5.4.3.1.1 Unicast Rules

SIP-004050 The OPTIONAL parameters “profile-level-id,” “packetization-mode,” and “sprop-deint-buf-req,” if required by the packetization-mode, identify a media format configuration for H.264. If present in the sdp offer, then either the sdp answer MUST maintain all these configuration parameters (as specified in the sdp offer) or remove the media format (payload type) completely, if one or more of the parameter values are not supported by the answerer.

SIP-004050.a The same RTP payload type number used in the offer SHOULD also be used in the answer, and an answer MUST NOT contain a payload type number used in the offer unless the configuration (“profile-level-id”, “packetization-mode”, and, if present, “sprop-deint-buf-req”) is the same as in the offer.

SIP-004060 The parameters “sprop-parameter-sets,” “sprop-deint-buf-req,” “sprop-interleaving-depth,” “sprop-max-don-diff,” and “sprop-init-buf-time” describe the properties of the NAL unit stream that the offeror or answerer is sending for this media format configuration.

NOTE: This is somewhat unusual as generally parameters describe the stream properties that the offeror or the answerer is able to receive.

SIP-004070 With respect to the capability parameters (i.e., “max-mbps,” “max-fs,” “max-cpb,” “max-dpb,” “max-br,” “redundant-pic-cap,” “max-rcmd-nalu-size”) when the direction attribute is sendonly, then the parameters describe the limits of the RTP packets and the NAL unit stream that the sender is capable of producing, and when the direction attribute is sendrecv or recvonly, then the parameters describe the limitations of what the receiver accepts.

SIP-004080 In the case of interleaved streams, it is RECOMMENDED that both parties include the OPTIONAL parameter “deint-buf-cap.” In addition, in the case of interleaved streams if the receiver capabilities are unknown, it is RECOMMENDED to consider offering multiple payload types with different buffering requirements.

SIP-004090 When the answerer receives an sdp offer with the OPTIONAL parameter “sprop-parameter-sets,” then the answerer MUST maintain all parameter sets received in the offer in its answer. The answerer also MUST accept to receive a video stream using the “sprop-parameter-sets” parameter it declared in the answer.

5.4.3.1.2 Additional Rules for Multicast

SIP-004100 The stream properties parameters (“sprop-parameter-sets,” “sprop deint buf-req,” “sprop-interleaving-depth,” “sprop-max-don-diff,” and “sprop init-buf-time”) MUST NOT be changed by the answerer. A payload type can be accepted either unaltered or removed.

SIP-004110 The receiver capability parameters “max-mbps,” “max-fs,” “max-cpb,” “max dpb,” “max-br,” and “max-rcmd-nalu-size” MUST be supported by the answerer for all streams declared as sendrecv or recvonly; otherwise either the media format MUST be removed or the session rejected.

5.4.3.2 Interaction of H.264 OPTIONAL Parameter Capability Exchange and Direction Attribute

SIP-004120 In offers and answers for which “a=sendrecv” or no direction attribute is used, or for which “a=recvonly” is used, then we interpret:

- “profile-level-id” and “packetization-mode” as declaring the actual configuration or properties for receiving
- (only when “a=sendrecv” or no direction attribute is used) “sprop deint buf req,” “sprop-interleaving-depth,” “sprop-parameter-sets,” “sprop-max-don-diff,” and “sprop-init-buf-time” as declaring actual properties of the stream to be sent
- “max-mbps,” “max-fs,” “max-cpb,” “max-dpb,” “max-br,” “redundant pic cap,” “deint-buf-cap,” and “max-rcmd-nalu-size” as declaring receiver implementation capabilities
- “parameter-add” as declaring how offer/answer negotiation shall be performed

SIP-004130 In offers and answers for which “a=sendonly” is used, then we interpret:

- “profile-level-id,” “packetization-mode,” “sprop-deint-buf-req,” “sprop max don-diff,” “sprop-init-buf-time,” “sprop-parameter-sets,” and “sprop interleaving-depth” as declaring actual configuration and properties of the stream proposed to be sent
- “max-mbps,” “max-fs,” “max-cpb,” “max-dpb,” “max-br,” “redundant pic cap,” “deint-buf-cap,” and “max-rcmd-nalu-size” as declaring the capabilities of the sender when it receives a stream
- “parameter-add” as declaring how offer/answer negotiation shall be performed

5.4.3.3 Miscellaneous H.264 Capability Exchange Rules

SIP-004140 Parameters used for declaring receiver capabilities are in general downgradable; therefore, a sender MAY select to set its encoder using only lower/lesser or equal values of these parameters.

SIP-004150 Parameters declaring a configuration point (i.e., RTP payload type) are not downgradable, except for the level part of the “profile-level-id” parameter.

SIP-004160 A receiver SHOULD understand all MIME parameters, even if it only supports a subset of the payload format’s functionality. This ensures that a receiver is capable of understanding when an offer to receive media can be downgraded to what is supported by the receiver of the offer.

SIP-004170 An answerer MAY extend the offer with additional media format configurations. In most cases, a second offer is required from the offeror to provide the stream properties parameters that the media sender will use. This also has the effect that the offeror has to be able to receive this media format configuration, not only to send it.

SIP-004180 If an offeror wishes to have non-symmetric capabilities between sending and receiving, the offeror has to offer different RTP sessions; i.e., different media lines declared as “recvonly” and “sendonly,” respectively.

SIP-004190 The AS-SIP signaling appliance must follow the requirements of RFC 6184, where it specifies the rules for applying H.264 parameters to the SDP offer/answer model (RFC 6184, Section 8.2.2, Usage with the SDP Offer/Answer Mode).

SIP-004200 The definitions of OPTIONAL parameters can be found in RFC 6184.

SIP-004210 Example of a H.264 sdp offer of the Baseline Profile, Level 1.2:

```
m=video 49170 RTP/AVP 98
a=rtptime:98 H264/90000
a=fmtp:98 profile-level-id=42E00C;
sprop-parameter-sets=Z0IACpZTBYmI,aMljiA==
```

where, in the profile-level-id parameter, 42 indicates Baseline profile, E0 indicates that only the common subset for all profiles is supported and 0C indicates level 1.2 and where the sprop-parameter-sets parameter conveys the properties of the NAL (network abstraction layer) unit stream that the offeror will be sending to the receiver.

5.5 SDP OFFER/ANSWER EXCHANGE

SIP-004220 RFC 3264 sets forth an offer/answer model for SDP.

SIP-004220.a The AS-SIP signaling appliance (and all AS-SIP EIs, including AS-SIP video conferencing EIs) MUST perform SDP offer/answer exchanges in compliance with

RFC 3264 with additional rules for SIP video listed in [Section 5.6](#), Additional Offer/Answer Rules for AS-SIP Video.

SIP-004220.b The AS-SIP signaling appliance (and all AS-SIP EIs, including AS-SIP video conferencing EIs) MUST comply with:

- RFC 3264, Section 5, Generating the Initial Offer.
- RFC 3264, Section 6, Generating the Answer.
- RFC 3264, Section 7, Offeror Processing of the Answer.
- RFC 3264, Section 8, Modifying the Session.
- RFC 3264, Section 9, Indicating Capabilities.

5.6 ADDITIONAL OFFER/ANSWER RULES FOR AS-SIP VIDEO

5.6.1 Generating the Initial Offer

SIP-004230 The SCs serving IP EIs other than AS-SIP EIs and all AS-SIP EIs including AS-SIP video conferencing EIs shall include bandwidth modifiers for the video “m=” lines in the SDP.

5.6.2 Generating the Answer

SIP-004240 The answer must include bandwidth modifiers in all video media streams.

SIP-004250 The value of the bandwidth modifier in each video “m=” line must not be greater than the value in the corresponding video “m=” line listed in the initial offers.

SIP-004260 The answerer MUST send a media stream using a media format in the offer that is also listed in the answer, and SHOULD send using the most preferred media format in the offer that is also listed in the answer.

SIP-004270 The answerer MUST send media using a bandwidth that is not greater than the value of the bandwidth attribute in the answer.

5.6.3 Offeror Processing of the Answer

SIP-004280 The offeror MUST send a media stream using a media format listed in the answer, and it SHOULD use the first media format listed in the answer (RFC 3264).

SIP-004290 The offeror MUST send the video media stream using a bandwidth that is no higher than the value of the bandwidth modifier returned in the answer.

5.7 SDP EXAMPLES

5.7.1 Basic SDP Exchange

The caller, Alice, wants to call the callee, Bob. Alice's codec generates the offer as:

[Offer]

```
v=0
o=Alice 1627471320 1627471320 IN IP4 192.168.100.146
s=-
c=IN IP4 192.168.100.146
b=AS:384
t=0 0
    m=audio 49178 RTP/AVP 0 8 18

    b=TIAS:64000
    a=rtpmap:0 PCMU/8000
    a=rtpmap:8 PCMA/8000
    a=rtpmap:18 G729A/8000
        m=video 49180 RTP/AVP 109 34 96 31

    b=TIAS:320000
    a=rtpmap:109 H264/90000
    a=fmtp:109 profile-level-id=42800c;max-ambps=10000
    a=rtpmap:34 H263/90000
    a=rtpmap:96 H263-1998/90000
    a=fmtp:96 SQCIF=1;QCIF=1;CIF=1;CIF4=2;F;J;T
    a=rtpmap:31 H261/90000
        a=fmtp:31 CIF=1;QCIF=1
```

Bob's codec has a lower bandwidth profile so it generates the answer as:

[Answer]

```
v=0
o=Bob 2890844730 2890844730 IN IP4 host.example.com
s=-
c=IN IP4 host.example.com
b=AS:300
t=0 0

m=audio 49920 RTP/AVP 18
b=TIAS:8000
a=rtpmap:18 G729A/8000
m=video 53000 RTP/AVP 109
```

b=TIAS:248000
a=rtpmap:109 H264/90000
a=fmtp:109 profile-level-id=42800c;max-mps=10000

SECTION 6 PRECEDENCE AND PREEMPTION

This section provides the detailed requirements for the execution of preemption and the handling of precedence information.

6.1 PRECEDENCE LEVEL COMMUNICATED OVER SIP SIGNALING

This section of the UCR incorporates a number of modifications to RFC 4412. In particular, a modification has been made to the fields of the Resource-Priority header whereby the namespace has been subdivided into two subfields: network-domain and precedence-domain; separated by a dash delimiter (-) (ASCII 45d). This modification affects the processing rules for the Resource-Priority header. In addition, single character text string representations of decimal digits have been defined for the r-priority values associated with the “uc”, “dsn”, and “cuc” network domains.

6.1.1 Resource-Priority Header Field

SIP-004300 The precedence level of the call request **MUST** be set forth in a SIP Resource-Priority header field whose syntax is IAW RFC 4412, as modified in, [Section 6.1](#), Precedence Level Communicated Over SIP Signaling (RFC 4412, Section 3.1, The ‘Resource-Priority’ Header Field).

Resource-Priority	=	"Resource-Priority" HCOLON r-value *(COMMA r-value)
r-value	=	namespace .? r-priority
namespace	=	1*10token-nodot “-“ 6*precedence-domain
r-priority	=	1*token-nodot
precedence-domain	=	"0"/ "1"/ "2"/ "3"/ "4"/ "5"/ "6"/ "7"/ "8"/ "9" / "A"/ "B"/ "C"/ "D"/ "E"/ "F"
token-nodot	=	1*(alphanum/ "!"/ "%"/ "*" / "_"/ "+" / "`"/ "" / "~")
alphanum	=	ALPHA/ DIGIT
HCOLON	=	“:” SWS
COMMA	=	SWS “,” SWS
SWS	=	[LWS]
LWS	=	[*WSP CRLF] 1*WSP

WSP	=	SP/ HTAB
CRLF	=	CR LF
ALPHA	=	%x41-5A/ %x61-7A ; A-Z/ a-z
DIGIT	=	%x30-39; 0-9
SP	=	%x20
HTAB	=	%x09
CR	=	%x0D
LF	=	%x0A

Example of Resource-Priority header field whose network-domain subfield is “uc,” whose r-priority field has the value “priority,” and whose precedence-domain subfield is “000000”:

Resource-Priority: uc-000000.2

NOTE: The r-priority values assigned to the various precedence levels of the “uc” network domain consist of a single-character text string for an authorized decimal digit. The r-priority values assigned to the various precedence levels of the “dsn” network domain consist of a single-character text string for an authorized decimal digit. Moreover, the precedence levels of the “uc” and “dsn” network domains are identical and the corresponding single-character text strings are also identical. The r-priority values assigned to the various precedence levels of the “cuc” network domain consist of a single-character text string for an authorized decimal digit.

6.1.1.1 Namespace

SIP-004310 The namespace consists of two subfields: network-domain and precedence-domain, which are separated by the dash delimiter (-) (which is ASCII 45d).

SIP-004320 The network-domain subfield identifies the applicable priority scheme and dictates the set of legitimate values that may be assigned to the accompanying r-priority field.

6.1.1.2 *Configuring the Set of Network-Domain Values To Be Received and Recognized by an AS-SIP Signaling Appliance or AS-SIP EI with P&P*

SIP-004330 The set of valid values for the network-domain received by a given AS-SIP signaling appliance (SC or SS) SHALL be configurable by the network administrator at installation and at any time thereafter. The set of valid values for the network-domain is configurable on a per appliance basis whereby one set of valid values for the network-domain applies to all IP EIs served by a given AS-SIP signaling appliance. The network administrator SHALL be able to designate at least two different values for the network-domain that an AS-SIP

signaling appliance will receive and recognize. In particular, currently the network administrator SHALL be able to configure AS-SIP signaling appliances to receive and recognize both the “uc” network-domain and the “dsn” network-domain or just the “uc” network-domain or just the “dsn” network-domain.

NOTE: [**Conditional**] It is recommended that AS-SIP signaling appliances provide the capability to be configured to receive and recognize up to 32 values for the network-domain.

SIP-004330.a (Classified network only.) The set of valid values for the network-domain received by a given AS-SIP signaling appliance (SC or SS) SHALL be configurable by the network administrator at installation and at any time thereafter. The set of valid values for the network-domain is configurable on a per appliance basis whereby one set of valid values for the network-domain applies to all IP EIs served by a given AS-SIP signaling appliance. Currently the only valid configurable value for the network-domain on the classified network is: “cuc.”

| **SIP-004340** [**Required: AS-SIP EIs with P&P**] The set of valid values for the network-domain received by a given AS-SIP EI SHALL be configurable by the network administrator at installation and at any time thereafter. The network administrator SHALL be able to designate at least two different values for the network-domain that the AS-SIP EI will be able to receive and recognize. In particular, currently the network administrator SHALL be able to configure AS-SIP EIs to receive and recognize both the “uc” network-domain and the “dsn” network-domain or just the “uc” network-domain or just the “dsn” network-domain.

| NOTE: [**Conditional: AS-SIP EIs with P&P**] It is recommended that AS-SIP EIs provide the capability to be configured to receive, recognize and process up to 32 values for the network-domain.

| **SIP-004340.a** [**Required: AS-SIP EIs with P&P**] (Classified network only.) The set of valid values for the network-domain received by a given AS-SIP EI SHALL be configurable by the network administrator at installation and at any time thereafter. Currently the only valid configurable value for the network-domain on the classified network is: “cuc.”

6.1.1.3 Configuring the Network-Domain Value To Be Generated by an AS-SIP Signaling Appliance or AS-SIP EI with P&P

| **SIP-004350** The value of the network-domain field of a Resource-Priority header generated by an AS-SIP signaling appliance on behalf of a served proprietary EI or on behalf of a served RO AS-SIP EI or on behalf of an inter-worked TDM call request SHALL be configurable by the network administrator. Currently the valid configurable values for the network-domain field of the Resource-Priority header in the SBU network are: “uc”, “dsn.”

NOTE: Vendors are NOT precluded from enabling the network administrator to assign different values for the network-domain to different served proprietary EIs or RO AS-SIP EIs or precluded from enabling the network administrator to assign different values for the network-domain to different trunk groups in the case of inter-worked TDM calls.

SIP-004350.a (Classified only) The value of the network-domain field of a Resource-Priority header generated by an AS-SIP signaling appliance on behalf of a served proprietary EI or on behalf of a served RO AS-SIP EI or on behalf of an inter-worked TDM call request SHALL be configurable by the network administrator. Currently the only valid configurable value for the network-domain field in the Resource-Priority header on the classified network is “cuc.”

SIP-004360 [Required: AS-SIP EI with P&P] The value of the network-domain field of a Resource-Priority header generated by an AS-SIP EI SHALL be configurable by the network administrator. Currently the valid configurable values for the network-domain field of the Resource-Priority header in the SBU network are: “uc”, “dsn.”

SIP-004360.a [Required: AS-SIP EI with P&P] (Classified only) The value of the network-domain field of a Resource-Priority header generated by an AS-SIP EI SHALL be configurable by the network administrator. Currently the only valid configurable value for the network-domain field in the Resource-Priority header of the classified network is “cuc.”

SIP-004370 The precedence-domain subfield is a string of six alphanumeric characters from the set: “0,” “1,” “2,” “3,” “4,” “5,” “6,” “7,” “8,” “9,” “A,” “B,” “C,” “D,” “E,” and “F.”

SIP-004380 Call requests are permitted to preempt other call requests and other calls that have the same value for the precedence-domain subfield.

SIP-004390 Call requests are NOT permitted to preempt other call requests and other calls that have a different value for the precedence-domain subfield.

IMPORTANT NOTE: Currently there is only 1 valid configured value for the precedence-domain subfield: “000000” and therefore, at present, when a SC receives a request intended for a served IP EI and the value of the precedence-domain subfield in the Resource-Priority header is not “000000” the SC treats the request as if the precedence-domain were “000000” (e.g. see SIP-004640 and SIP-004650). Similarly, at present, if an AS-SIP EI with P&P receives a request and the value of the precedence-domain subfield in the Resource-Priority header is not “000000” the AS-SIP EI with P&P treats the request as if the precedence-domain were “000000” (e.g. see SIP-004660 and SIP-004670).

When the set of values that may be assigned to the precedence-domain subfield expands beyond “000000” to comprise two or more members then:

- The SC that receives an inbound INVITE intended for a served IP EI with a Resource-Priority header whose precedence-domain does not have the value “000000” will no longer be treated as if the value of the precedence-domain is “000000”.
- The AS-SIP EI with P&P that receives an inbound INVITE with a Resource-Priority header whose precedence-domain does not have the value “000000” will no longer be treated as if the value of the precedence-domain is “000000”.
- It will be possible for calls and call requests to have different values for the precedence-domain subfield and for calls and call requests to become non-preemptable against one another because the values of their precedence-domain subfields are different (e.g. see SIP-004390, SIP-004400, SIP-005120).

SIP-004400 (See note in SIP-004390) When a circumstance arises whereby an AS-SIP signaling appliance receives a precedence call request and is called on to make a preemption decision, the AS-SIP signaling appliance can only preempt calls of lesser precedence that have the same value for the precedence-domain as the pending precedence call request.

SIP-004410 The default value for the precedence-domain field is “000000”.

6.1.1.4 r-priority

SIP-004420 To protect against external inferences regarding the precedence level of SIP signaling messages that, in part, exploit analysis of the length of encrypted messages, a one-to-one correspondence has been defined between each precedence level in the “uc” network-domain and a single character text string representation of a decimal value and the identical one-to-one correspondence has been defined for each precedence level of the “dsn” network-domain (see [Table 6.1-1](#), r-priority Values Applicable to “uc” network-domain and “dsn” network-domain).

Table 6.1-1. r-priority Values Applicable to “UC” Network-Domain and “DSN” Network-Domain

R-PRIORITY	CORRESPONDING DECIMAL VALUE
routine	“0”
priority	“2”
immediate	“4”
flash	“6”
flash-override	“8”

SIP-004430 Whenever a Resource-Priority header field has a network domain subfield with the value “uc” or “dsn” then the r-priority value must be the single character text string representation of the decimal digit corresponding to the intended precedence level as depicted in [Table 6.1-1](#), r-priority Values.

SIP-004440 The AS-SIP signaling appliances and AS-SIP EIs with P&P MUST support the r-priority values ‘0’, ‘2’, ‘4’, ‘6’, and ‘8’ for the network-domain “uc” and for the network-domain “dsn.”

6.1.1.5 *Classified Only Requirement*

SIP-004450 To protect against external inferences regarding the precedence level of SIP signaling messages that, in part, exploit analysis of the length of encrypted messages, a one-to-one correspondence has been defined between each precedence level in the “cuc” network domain and a single-character text string representation of a decimal value (see [Table 6.1-2](#)).

Table 6.1-2. r-priority Values

R-PRIORITY	CORRESPONDING DECIMAL VALUE
routine	“0”
priority	“2”
immediate	“4”
flash	“6”
flash-override	“8”
flash-override-override	“9”

SIP-004460 Whenever a Resource-Priority header field has a network domain subfield with the value “cuc” then the r-priority value must be the single-character text string representation of the decimal digit corresponding to the intended precedence level as depicted in [Table 6.1-2](#), r-priority Values.

SIP-004470 The AS-SIP signaling appliances MUST support the r-priority values “0,” “2,” “4,” “6,” “8,” and “9” for the network domain “cuc.”

6.1.2 Requirements for SCs Serving IP EIs

The SCs serving IP EIs refer to SCs and to the SC component of SSs that directly serve IP EIs.

NOTE: For the classified network, the default network-domain subfield is “cuc.” The requirements set forth in [Section 6.1.2](#) are made applicable to the classified network by substituting “cuc” for “uc” in each requirement.

6.1.2.1 *SIP Message Without Resource-Priority Header Received From Served AS-SIP EI or SIP EI*

SIP-004474 Whenever a SC receives an INVITE, UPDATE, or REFER request from a served AS-SIP EI that does not contain a Resource-Priority header field, the SC MUST add a Resource-Priority header having one resource value (i.e., namespace.r-priority). The SC assigns the appropriate values for the namespace (i.e., the configured value for generating the network-domain subfield: e.g., “uc” or “dsn” and the precedence-domain subfield: “000000”) and for the

r-priority field IAW the dialed string and local policy). In the case of precedence call requests, the SC MAY authenticate the requester and determine that the requester is authorized to use the precedence level before forwarding the SIP message. If these conditions are not met, then, Section 6.1.4, Error Conditions, subsections Authentication Failure and Authorization Failure detail the error handling.

SIP-004476 When a SC (that does not keep track of the EI category to which each of its served AS-SIP EIs belongs) receives an initial INVITE from a served AS-SIP EI in which the value of the precedence digit signifies a call priority greater than ‘routine’ the AS-SIP EI in question may be a RO AS-SIP EI. The SC would not be aware of this and will process the initial INVITE as described above in requirement SIP-004474.

SIP-004478 [Optional: SC] When a SC (that keeps track of the EI category to which each of its served AS-SIP EIs belongs) receives an initial INVITE from a served RO AS-SIP EI in which the value of the precedence digit signifies a call priority greater than ‘routine’, the SC plays the Unauthorized Precedence Announcement (UPA) to the caller at the RO AS-SIP EI and then sends a 403 Forbidden to terminate the call. (The SC follows the procedure described in SIP-004730.a and depicted in Fig. 6.1-1 with the exception that the SC does not send the 407 with Proxy-Authenticate header and the RO AS-SIP EI does not reply with the INVITE with Proxy-Authentication header).

SIP-004480 Whenever an SC receives an INVITE, UPDATE, or REFER request from a served SIP EI that does not contain a Resource-Priority header field, the SC MUST add a Resource-Priority header having one resource value (i.e., namespace.r-priority). The SC assigns the appropriate values for the namespace (i.e., the configured value for generating the network-domain subfield: e.g., “uc” or “dsn” and the precedence-domain subfield: “000000”) and for the r-priority field IAW the dialed string and local policy). In the case of precedence call requests, the SC MAY authenticate the requester and determine that the requester is authorized to use the precedence level before forwarding the SIP message. If these conditions are not met, then, [Section 6.1.4](#), Error Conditions, subsections Authentication Failure and Authorization Failure detail the error handling.

6.1.2.2 SIP Message With Resource-Priority Header Received From Served AS-SIP EI or SIP End Instrument

SIP-004490 Whenever an SC receives a call signaling message from a served AS-SIP EI with P&P or a served SIP EI having a Resource-Priority header, the SC MUST ensure that the Resource-Priority header field contains a namespace having a valid network domain subfield, a valid precedence-domain subfield, and an authorized r-priority value for the given network domain subfield.

Note: AS-SIP EIs are NOT required to generate a Resource-Priority header when creating an initial INVITE or a REFER request. AS-SIP EIs with P&P are required to be able to process the Resource-Priority header present in any request that they receive.

The value of the network-domain subfield received from a directly served AS-SIP EI [with P&P](#) or SIP EI is considered valid when it is known to the SC and when its use by the AS-SIP EI [with P&P](#) or SIP EI is consistent with local policy. This means that the value of the network-domain subfield in the Resource-Priority header received from the directly served AS-SIP EI [with P&P](#) or SIP EI matches the SC's configured value for generating a network-domain subfield.

NOTE: In the case of precedence call requests, the SC MAY authenticate the requester and determine that the requester is authorized to use the precedence level before forwarding the AS-SIP request. If these conditions are not met, then, [Section 6.1.4](#), Error Conditions, subsections Authentication Failure and Authorization Failure detail the error handling.

A precedence-domain subfield received from a directly served AS-SIP EI [with P&P](#) or SIP EI is considered valid when it has a conformant syntax and when the value is consistent with local policy. The valid value for a precedence-domain subfield in the namespace of a Resource-Priority header in an AS-SIP message originating from a served AS-SIP EI [with P&P](#) or SIP EI is the text string "000000".

6.1.2.2.1 (Unknown Network-Domain) No Require Header or Require Header but No 'Resource-Priority' Option Tag

SIP-004500 When the SC receives an AS-SIP request from a served AS-SIP EI [with P&P](#) (or from a served SIP EI) having a Resource-Priority header but either not having a Require header or having a Require header but not the option tag "Resource-Priority"²¹ then:

SIP-004510 In the event the network-domain from the served AS-SIP EI [with P&P](#) (or SIP EI) does not match the SC's configured value for generating a network-domain then the SC SHALL replace the received value for the network-domain with the SC's configured value for generating a network-domain and set the value in the r-priority field to the lowest priority level (e.g., "0" for both "uc" and "dsn").

SIP-004520 In the event the SC receives an AS-SIP request from a served AS-SIP EI [with P&P](#) or SIP EI with a Resource-Priority header having multiple resource values (i.e., resource value = namespace.r-priority) or an AS-SIP request having multiple Resource-Priority headers then:

- If none of the resource values matches the SC's configured value for generating the network-domain, then the SC MUST remove all the existing Resource-Priority headers and replace them with one Resource-Priority header having the SC's configured value for generating the network-domain and an r-priority value of the lowest priority level (e.g., "0" for both "uc" and "dsn"). The precedence-domain subfield MUST be assigned the text string "000000".

²¹ see [Section 6.1.3](#) Option Tag "Resource-Priority"

6.1.2.2.2 (Unknown Network-Domain) Require Header With 'Resource-Priority' Option Tag

SIP-004530 When the SC receives an AS-SIP request from a served AS-SIP EI [with P&P](#) (or from a served SIP EI) having a Resource-Priority header and a Require header with the option tag "Resource-Priority"²² then:

SIP-004530.a In the event the network-domain from the served AS-SIP EI [with P&P](#) or SIP EI does not match the SC's configured value for generating a network-domain then the SC MUST reject the request with a 417 (Unknown Resource-Priority) response code.

SIP-004530.b In the event the SC receives an AS-SIP request from a served AS-SIP EI [with P&P](#) or SIP EI with a Resource-Priority header having multiple resource values (i.e., resource value =namespace.r-priority) or an AS-SIP request having multiple Resource-Priority headers then:

- If none of the resource values matches the SC's configured value for generating the network-domain then the SC MUST reject the request with a 417 (Unknown Resource-Priority) response code.

6.1.2.2.3 (Valid Network-Domain) No Require Header or Require Header but No 'Resource-Priority' Option Tag

Note: The requirements in this section (6.1.2.2.3) apply when either there is no Require header present or, if there is a Require header present, the Require header does not have a 'resource-priority' option tag.

SIP-004540 When the SC receives an AS-SIP request from a served AS-SIP EI [with P&P](#) (or from a served SIP EI) having a Resource-Priority header and the network domain from the served AS-SIP EI [with P&P](#) (or SIP EI) matches the SC's configured value for generating a network-domain then the r-priority field MUST have a value that is from the authorized set of r-priority values for the given network-domain. When the value in the r-priority field is not valid, then the SC sets the r-priority field to the lowest priority level. In the case of both the "uc" network-domain and the "dsn" network-domain, the r-priority is set to "0".

SIP-004550 In the event the precedence-domain subfield in the Resource-Priority header received from the served AS-SIP EI [with P&P](#) or SIP EI has a value other than the text string "000000," the SC MUST change the value to the text string "000000".

SIP-004560 In the event the SC received an AS-SIP request from a served AS-SIP EI [with P&P](#) or SIP EI with a Resource-Priority header having multiple resource values (i.e., resource value = namespace.r-priority) or an AS-SIP request having multiple Resource-Priority headers then:

²² see [Section 6.1.3](#) Option Tag "resource-priority"

- If the network-domain of one of the resource values matches the SC's configured value for generating the network-domain then the SC MUST remove all but that one Resource-Priority header (and network-domain). If the precedence-domain subfield is any value other than the text string "000000," then it must be replaced with the text string "000000". The r priority field MUST have an authorized value and if it does not, then the r-priority field will be assigned the lowest priority level (e.g. "0" for both "uc" and "dsn").
- If the SC's configured value for generating the network-domain appears in more than one resource value, then the SC MUST remove all the Resource-Priority headers and replace them with one Resource-Priority header populated with a resource value having the SC's configured value for generating the network domain and a r-priority field having the lowest priority level (e.g., "0" for both "uc" and "dsn"). The precedence domain field MUST be the text string "000000".

6.1.2.2.4 *(Valid Network-Domain) Require Header With "Resource-Priority" Option Tag*

Note: The requirements in this section (6.1.2.2.4) apply when a Require header is present and the Require header has a 'resource-priority' option tag.

SIP-004570 When the SC receives an AS-SIP request from a served AS-SIP EI with P&P (or from a served SIP EI) having a Resource-Priority header and the network domain from the served AS-SIP EI with P&P (or SIP EI) matches the SC's configured value for generating a network-domain then the r-priority field MUST have a value that is from the authorized set of r-priority values for the given network-domain. When the value in the r-priority field is not valid, then the SC MUST reject the request with a 417 (Unknown Resource-Priority) response code.

SIP-004580 In the event the SC received an AS-SIP request from a served AS-SIP EI with P&P or SIP EI with a Resource-Priority header having multiple resource values (i.e., resource value = namespace.r-priority) or an AS-SIP request having multiple Resource-Priority headers then:

- If one of the resource values is valid (i.e., network-domain subfield matches the SC's configured value for generating the network-domain and the r-priority field has a valid value) then the SC MUST remove all but that one Resource-Priority header. If the precedence-domain subfield is any value other than the text string "000000," then it must be replaced with the text string "000000".
- If multiple resource values are valid (i.e., have a network-domain subfield that matches the SC's configured value for generating the network-domain and r-priority fields having valid values) then the SC MUST remove all the Resource-Priority headers and replace them with one Resource-Priority header populated with a resource value having the SC's configured value for generating the network domain and a r-priority field having the lowest priority level (e.g., "0" for both "uc" and "dsn"). The precedence domain field MUST be the text string "000000".

6.1.2.3 Call Request Received From Served H.323 or Proprietary IP EI

SIP-004590 Whenever an SC receives a call signaling message from a served H.323 or proprietary IP EI that is translated into a SIP INVITE, UPDATE, or REFER request, the AS-SIP signaling appliance MUST add a Resource-Priority header having one resource value (i.e., namespace.r-priority). The SC assigns the appropriate values for the namespace (i.e., the SC’s configured value for generating the network-domain and the precedence-domain subfield set to: “000000”) and for the r-priority field IAW the dialed string and local policy. In the case of precedence call requests, the SC MAY authenticate the requester and determine that the requester is authorized to use the precedence level before forwarding the SIP message. If the precedence call request is not authenticated and the SC requires user authentication for precedence call requests then the SC MUST give the requester the opportunity to conduct the necessary authentication, and if the requester is not authorized to use the requested precedence level, then the Unauthorized Precedence Announcement (UPA) shall be announced and/or displayed to the user (see [Table 6.1-3](#), Announcements) through the EI. For switch name and location, the announcement shall indicate the local SC serving the IP EI. Then the call request MUST be terminated.

Table 6.1-3. Announcements

ANNOUNCEMENT CONDITION	ANNOUNCEMENT
An equal or higher precedence call is in progress	BPA. “(SC name and Location) or (“Remote AS-SIP signaling appliance”). Equal or higher precedence calls have prevented completion of your call. Please hang up and try again. This is a recording. (SC name and Location) or (“Remote AS-SIP signaling appliance”)”
Unauthorized Precedence level is attempted	UPA. “(SC name and Location). The precedence used is not authorized for your line. Please use an authorized precedence or ask your attendant for assistance. This is a recording. (SC name and Location).”
No such service or Vacant Code	VCA. “Remote AS-SIP signaling appliance. Your call cannot be completed as dialed. Please consult your directory and call again or ask your operator for assistance. This is a recording. Remote AS-SIP signaling appliance.”
Operating or equipment problems encountered	ICA. “(SC name and Location) or (“Remote AS-SIP signaling appliance”). A service disruption has prevented the completion of your call. Please wait 30 minutes and try again. In case of emergency call your operator. This is a recording. “(SC name and Location) or (“Remote AS-SIP signaling appliance”).”
Busy station not equipped for preemption	BNEA. “(SC name and Location) or (“Remote AS-SIP signaling appliance”). The number you have dialed is busy and not equipped for call waiting or preemption. Please hang up and try again. This is a recording. “(SC name and Location) or (“Remote AS-SIP signaling appliance”).”
Attendant Queue Announcement (ATQA)	“This is the <site name> Session Controller. All attendants are busy now. Please remain on the line until an attendant becomes available or try your call later. This is a recording. <site name> Session Controller.”

6.1.2.4 AS-SIP Message With Resource-Priority Header for Served IP EI

SIP-004600 The SCs serving IP EIs MUST support receiving and processing the Resource-Priority header field to determine whether to deny a call request or to preempt an existing call or call request and, if so, to create and send the appropriate signaling messages to implement the denial or preemption. See [Section 6.4](#), ASAC Preemption Requirements, for the details of the preemption requirements on AS-SIP signaling appliances.

6.1.3 Option Tag “resource-priority”

SIP-004610 The SCs serving H.323 or proprietary IP EIs MUST support [the ability to generate and to receive/process](#) the option tag “resource-priority” for use with the Require header field.²³

SIP-004610.a The SCs MUST receive and accept a Require header field with the option tag “resource-priority” in the INVITE, UPDATE, and REFER messages on behalf of the H.323 and proprietary EIs. The SCs MUST NOT reject the message with a 420 (Bad Extension) response, but rather they MUST accept the request and convert it as required for the non-SIP IP EI.

SIP-004620 The SCs serving SIP EIs that do not implement the Resource-Priority header MUST handle the option tag “resource-priority” in the Require header field on behalf of their served SIP EIs. The mechanism used by the SC is left to vendor-specific implementation.

SIP-004630 [\[Required: AS-SIP EIs with P&P\]](#) The AS-SIP EIs MUST support [the ability to generate and receive/process](#) ~~generating and receiving/processing~~ the option tag “resource-priority” in the Require header field. The AS-SIP EIs also MUST support receiving the option tag “resource-priority” in the Unsupported header.²⁴

SIP-004635 [\[Required: RO AS-SIP EI\]](#) If a RO AS-SIP EI receives a Request with a Require header having a “resource-priority” option tag then the RO AS-SIP EI MUST respond with a 420 (Bad Extension) that includes an Unsupported header having the “resource-priority” option tag.

²³ [If a SC or SS originates a Request that includes a Require header having the “resource-priority” option tag and receives a 420 \(Bad Extension\) response with an Unsupported header that includes the “resource-priority” option tag then the SC or SS MUST resend the Request and remove the “resource-priority” option tag from the Require header.](#)

²⁴ [If an AS-SIP EI with P&P originates a Request that includes a Require header having the “resource-priority” option tag and receives a 420 \(Bad Extension\) response with an Unsupported header that includes the “resource-priority” option tag then the AS-SIP EI with P&P MUST resend the Request and remove the “resource-priority” option tag from the Require header.](#)

6.1.4 Error Conditions

6.1.4.1 SC Serving IP EI: Improper Network-Domain, Priority Value, or Precedence-Domain

NOTE: For the classified network, the default network-domain subfield is “cuc.” The requirements set forth in [Section 6.1.4](#) are made applicable to the classified network by substituting “cuc” for “uc” in each requirement.

SIP-004640 When the SC receives a SIP request with a Resource-Priority header intended for a served IP EI and the SIP request either does not have a Require header or has a Require header but not the option tag “resource-priority,” then:

SIP-004640.a If the SC does not recognize the value of the network-domain subfield of the namespace, then the network-domain subfield is treated as if it were set to the SC’s configured value for generating the network domain and the r-priority value is treated as if it were set to the lowest priority level. If the precedence-domain subfield is either syntactically flawed or does not consist of the text string “000000,” then it is still treated as if it had the value of “000000”.

IMPLEMENTATION NOTE: One valid implementation for treating the precedence-domain subfield as if it had the value “000000” is for the SC to change the precedence-domain subfield to “000000”. It is by no means required that the SC convert the precedence-domain subfield to “000000,” but it is an allowed method for complying with the requirement. This implementation note applies to every requirement in the UCR that specifies the SC is to treat the precedence-domain subfield as if it had the value “000000”.

SIP-004640.a.1 If the SC recognizes the value of the network-domain subfield of the namespace but the r-priority field does not have an authorized value for the given network domain, then the r-priority value is treated as if it were set to the lowest priority level of that network-domain. If the precedence-domain subfield is either syntactically flawed or does not consist of the text string “000000,” then it is still treated as if it had the value “000000”.

SIP-004640.a.2 If the SC receives a namespace with a recognized network domain and an authorized r-priority value where the precedence-domain subfield has a text string that is either syntactically invalid or does not consist of the text string “000000,” then the precedence-domain subfield is treated as if it were set to the text string “000000”.

SIP-004650 When the SC receives a SIP request with a Resource-Priority header intended for a served IP EI and the SIP request has a Require header field with an option tag “resource-priority,” then:

SIP-004650.a If the SC does not recognize the value of the network-domain subfield of the namespace, then the SC MUST reject the request with a 417 (Unknown Resource-Priority) response code.

SIP-004650.b If the SC recognizes the value of the network-domain subfield but the value of the r-priority field is not valid for the given network domain, then the r-priority value is treated as if it were set to the lowest priority level. If the precedence-domain subfield has a text string that is syntactically invalid or does not consist of the text string “000000,” then the precedence-domain subfield is treated as if it were set to “000000”.

SIP-004650.c If the SC recognizes the value of the network domain and the r-priority field has an authorized value for the network domain but the precedence-domain subfield has a text string that is syntactically invalid or does not consist of the text string “000000,” then the precedence-domain subfield is treated as if it were set to “000000”.

6.1.4.2 AS-SIP IP EI: Improper Network-Domain, Priority Value, or Precedence-Domain

NOTE: The requirements set forth in [Section 6.1.4](#) are made applicable to the classified network by substituting “cuc” for “uc” in each requirement.

SIP-004660 **[Required: AS-SIP EI with P&P]** When the AS-SIP EI receives a SIP request with a Resource-Priority header that either does not have a Require header or has a Require header but not the option tag “resource-priority,” then:

SIP-004660.a **[Required: AS-SIP EI with P&P]** If the AS-SIP EI does not recognize the value of the network-domain subfield of the namespace, then the network-domain subfield is treated as if it were set to the configured value for generating the network domain and the r-priority value is treated as if it were set to the lowest priority level. If the precedence-domain subfield is either syntactically flawed or does not consist of the text string “000000,” then it is still treated as if it had the value “000000”.

SIP-004660.b **[Required: AS-SIP EI with P&P]** If the AS-SIP EI recognizes the value of the network-domain subfield of the namespace but the r-priority field does not have an authorized value for the given network domain, then the r-priority value is treated as if it were set to the lowest priority level. If the precedence-domain subfield is either syntactically flawed or does not consist of the text string “000000,” then it is still treated as if it had the value “000000”.

SIP-004660.c **[Required: AS-SIP EI with P&P]** If the AS-SIP EI receives a namespace with a recognized network domain and an authorized r-priority value where the precedence-domain subfield has a text string that is either syntactically invalid or does not consist of the text string “000000,” then the precedence-domain subfield is treated as if it were set to the text string “000000”.

SIP-004670 [**Required: AS-SIP EI with P&P**] When the AS-SIP EI receives a SIP request with a Resource-Priority header and the SIP request has a Require header field with an option tag “resource-priority,” then:

SIP-004670.a [**Required: AS-SIP EI with P&P**] If the AS-SIP EI does not recognize the value of the network-domain subfield of the namespace, then the AS-SIP EI MUST reject the request with a 417 (Unknown Resource-Priority) response code.

SIP-004670.b [**Required: AS-SIP EI with P&P**] If the AS-SIP EI recognizes the value of the network-domain subfield but the value of the r-priority field is not valid for the given network domain, then the r-priority value is treated as if it were set to the lowest priority level. If the precedence-domain subfield has a text string that is syntactically invalid or does not consist of the text string “000000,” then the precedence-domain subfield is treated as if it were set to “000000”.

SIP-004670.c [**Required: AS-SIP EI with P&P**] If the AS-SIP EI recognizes the value of the network domain and the r-priority field has an authorized value for the network domain but the precedence-domain subfield has a text string that is syntactically invalid or does not consist of the text string “000000,” then the precedence-domain subfield is treated as if it were set to “000000”.

6.1.4.3 Originating SS²⁵: Improper Network-Domain, Priority Value, or Precedence-Domain

SIP-004680 [**Objective**] When an SS receives a SIP request with a Resource-Priority header from a served SC and the SIP request either does not have a Require header or has a Require header but not the option tag “resource-priority,” then:

SIP-004680.a [**Objective**] If the SS does not recognize the value of the network-domain subfield of the namespace, then for ASAC classification purposes, which become significant when the SS is called on to conduct policing (see [Section 7](#), SS Policing of Call Count Thresholds), the SIP message is classified as follows:

- Network-domain subfield equals the configured value for generating a network domain.
- R-priority value equals “0” (routine).
- Precedence-domain subfield equals “000000”.

SIP-004680.b [**Objective**] If the SS recognizes the value of the network-domain subfield of the namespace but the r-priority field does not have an authorized value for the given network domain, then for ASAC classification purposes the SIP message is classified as follows:

²⁵ The term originating SS refers to a SS that receives an INVITE from a served SC. The requirements in 6.1.4.3 apply to an originating SS.

- Network-domain subfield is not changed.
- R-priority value is treated as if it were set to the lowest priority level (i.e., “0”).
- Precedence-domain subfield equals “000000”.

SIP-004680.c [Objective] If the SS receives a namespace with a recognized network domain and an authorized r-priority value where the precedence-domain subfield has a text string that is either syntactically invalid or does not consist of the text string “000000,” then the precedence-domain subfield is classified as if it were set to the text string “000000”.

SIP-004690 [Objective] When an SS receives a SIP request with a Resource-Priority header from a served SC and the SIP request has a Require header field with an option tag “resource-priority,” then:

SIP-004690.a [Objective] If the SS does not recognize the value of the network-domain subfield of the namespace, then the SS MUST reject the request with a 417 (Unknown Resource-Priority) response code.²⁶

SIP-004690.b [Objective] If the SS recognizes the value of the network-domain subfield but the value of the r-priority field is not valid for the given network domain, then for ASAC classification purposes the SIP message is classified as follows:

- Network-domain subfield is not changed.
- The r-priority value is treated as if it were set to the lowest priority level (i.e., “0”).
- Precedence-domain subfield equals “000000”.

SIP-004690.c [Objective] If the SS recognizes the value of the network domain and the r-priority field has an authorized value for the network domain but the precedence-domain subfield has a text string that is syntactically invalid or does not consist of the text string “000000,” then the precedence-domain subfield is classified as if it were set to “000000”.

6.1.4.4 Terminating SS²⁷: Improper Network-Domain, Priority Value, or Precedence-Domain

SIP-004700 [Objective] When an SS receives a SIP request with a Resource-Priority header intended for a served SC and the SIP request either does not have a Require header or has a Require header but not the option tag “resource-priority,” then the SS takes no action about the Resource-Priority header until it receives a response from the served SC and proceeds as follows:

²⁶ The SS performs a comparison of the value of the network-domain received from the served SC with the set of network-domain values that the SS has been configured to accept and process.

²⁷ The term terminating SS refers to a SS that forwards an INVITE to a served SC. The requirements in 6.1.4.4 apply to a terminating SS.

SIP-004700.a [Objective] If the served SC responds with a 1xx response code greater than a 100 or a 200 and if the SS does not recognize the value of the network-domain subfield of the namespace, then for ASAC classification purposes the SIP message is classified as follows:

- Network-domain subfield equals the configured value for generating the network domain
- r-priority value equals “0” (routine).
- Precedence-domain subfield equals “000000”.

SIP-004700.b [Objective] If the served SC responds with a 1xx response code greater than a 100 or a 200 and if the SS recognizes the value of the network-domain subfield of the namespace but the r-priority field does not have an authorized value for the given network domain, then for ASAC classification purposes the SIP message is classified as follows:

- Network-domain subfield is not changed.
- R-priority value is treated as if it were set to the lowest priority level (i.e., it is “0”).
- Precedence-domain subfield equals “000000”.

SIP-004700.c [Objective] If the served SC responds with a 1xx response code greater than a 100 or a 200 and if the SS receives a namespace with a recognized network domain and an authorized r-priority value whose precedence-domain subfield has a text string that is either syntactically invalid or does not consist of the text string “000000,” then the precedence-domain subfield is classified as if it were set to the text string “000000”.

SIP-004710 [Objective] When an SS receives a SIP request with a Resource-Priority header from a served SC and the SIP request has a Require header field with an option tag “resource-priority,” then the SS takes no action about the Resource-Priority header until it receives a response from the served SC and proceeds as follows:

SIP-004710.a [Objective] If the served SC responds with a 1xx response code greater than a 100 or a 200 and if the SS does not recognize the value of the network domain subfield of the namespace²⁸, then the SS MUST:

- Send a 417 (Unknown Resource-Priority) response code to the remote initiating party.
- Send a CANCEL request (in the case of a 1xx response code) or a BYE request (in the case of a 2xx response code) to the local SC.

SIP-004710.b [Objective] If the served SC responds with a 1xx response code greater than a 100 or a 200 and if the SS recognizes the value of the network-domain subfield but

²⁸ The SS performs a comparison of the value of the network-domain sent to the served SC with the set of network-domain values that the SS has been configured to accept and process.

the value of the r-priority field is not valid for the given network domain, then for ASAC classification purposes the SIP message is classified as follows:

- Network-domain subfield is not changed.
- R-priority value is treated as if it were set to the lowest priority level (i.e., it is “0”).
- Precedence-domain subfield equals “000000”.

SIP-004710.c [Objective] If the served SC responds with a 1xx response code greater than 100 or a 200 and if the SS recognizes the value of the network domain and the r priority field has an authorized value for the network domain but the precedence-domain subfield has a text string that is syntactically invalid or does not consist of the text string “000000,” then the precedence-domain subfield is classified as if it were set to “000000”.

6.1.4.5 Authentication Failure

SIP-004720 The SC serving IP EIs ~~are-is~~ responsible for the authentication of the IP EIs it represents, and in the case of outbound precedence call requests, the SC May support authentication of the requestor and MAY be software configurable for enabling or disabling authentication of the requestor. In the event that the requesting IP EI ~~uses AS-SIP signaling (i.e., is an AS-SIP EI with P&P)~~ and the SC supports requestor authentication and is configured with requestor authentication enabled, and the requestor of an outbound precedence call request is not authenticated²⁹, then the SC MUST return the request to allow the requestor to insert the appropriate credentials. A 407 (Proxy Authentication Required) response code that includes the Proxy-Authenticate header shall be sent to the AS-SIP EI.

SIP-004720.a If the AS-SIP EI resends the INVITE with a Proxy-Authorization header where the response has a valid value for the challenge specified in the Proxy-Authenticate header of the 407 (Proxy Authentication Required) response, then the authentication succeeds. The numeric User-ID and PIN used by the AS-SIP EI in generating the Proxy-Authorization header in the INVITE must conform to the DISA FSO STIGs.

NOTE: When a user authenticates to the SC as a valid user successfully, then based upon the user’s profile, the SC determines whether the user is authorized to assert the priority level located in the Resource-Priority header. If the user is authorized for the asserted priority level then the precedence INVITE call proceeds normally; if the user is NOT authorized for the asserted priority level, then the authorization fails and the SC rejects the INVITE per UCR Requirement SIP-004730.

²⁹ The SC receives a precedence INVITE without a Proxy-Authorization header or with a Proxy-Authorization header that is not in response to an authentication challenge from the SC. The SC responds with a 407 (Proxy Authentication Required) response code that includes a Proxy-Authenticate header and the AS-SIP EI either resends the INVITE but fails to include a Proxy-Authorization header or resends the INVITE with an invalid response field in the Proxy-Authorization header.

SIP-004720.b If the AS-SIP EI resends the INVITE with a Proxy-Authorization header where the response does NOT have a valid value for the challenge specified in the Proxy-Authenticate header of the 407 (Proxy Authentication Required) response, then the authentication fails. The SC again sends a 407 response that includes a Proxy-Authenticate header with a new challenge. If the AS-SIP EI again resends the INVITE with a Proxy-Authorization header where the response does NOT have a valid value for the challenge specified in the Proxy-Authenticate header of the 407 response, then the authentication fails. The SC responds with a third 407 response, and this time, the AS-SIP EI plays the reorder tone to the caller. The reorder tone is a dual-frequency tone of 480 Hz and 620 Hz at a cadence of .25 seconds on and .25 seconds off.

NOTE: The mechanisms used to authenticate the initiator of above ROUTINE precedence sessions is described in, UCR Section 4.2.5 VVoIP Authentication.

6.1.4.6 Authorization Failure

SIP-004730 The SCs serving IP EIs are responsible for the authorization of the IP EIs they represent and this includes the authority to request a particular precedence level. If the requesting IP EI requests a precedence level for which the user has insufficient authorization, then the responsible SC MUST announce and/or display the UPA to the user (see [Table 6.1-3](#), Announcements) through the EI (for switch name and location, the announcement shall indicate the SC serving the IP EI), and reject the call.

SIP-004730.a In the case of a served AS-SIP EI with P&P, when the INVITE asserts a precedence level for which the user has insufficient authorization³⁰, then the SC establishes a bearer connection between the AS-SIP EI and a media server associated with the SC. Please see [Figure 6.1-1](#), SC/Media Server Plays UPA to AS-SIP EI. The SC and media server exchange the necessary signaling to provide the media server with the IP address and UDP port for the bearer stream with the AS-SIP EI and the SC instructs the media server to play the UPA over the bearer stream to the AS-SIP EI after the bearer is established. The 183 (Session Progress) response sent by the SC to the AS-SIP EI includes the sdp answer with the IP address and UDP port for a bearer stream with the media server. The AS-SIP EI responds with a PRACK to which the SC responds with a 200 (OK) response. The media server plays the announcement to the AS-SIP EI and terminates the session with the SC, and the SC sends a 403 (Forbidden) response to the AS-SIP EI. The AS-SIP EI responds with an ACK and terminates the call request.

NOTE: The media server is considered a part of the SC SUT; therefore, the signaling between the SC and media server is left to the vendor as long as the announcement is played and the signaling between the SC and AS-SIP EI complies with the specific call flow depicted in this section.

³⁰ The SC receives an INVITE with a Proxy-Authorization header; however, the user is not authorized to request the precedence level asserted in the Resource-Priority header.

SIP-004740 The SC MUST support the playing of the following announcements listed in [Table 6.1-3](#), Announcements: BPA, UPA, BNEA, VCA, and ICA.

SIP-004750 When the announcement is VCA or when the announcement is BPA, BNEA or ICA and the location of the event is a remote AS-SIP signaling appliance, then the announcement in [Table 6.1-3](#), Announcements, identifies the switch name and location as “remote AS-SIP signaling appliance.”

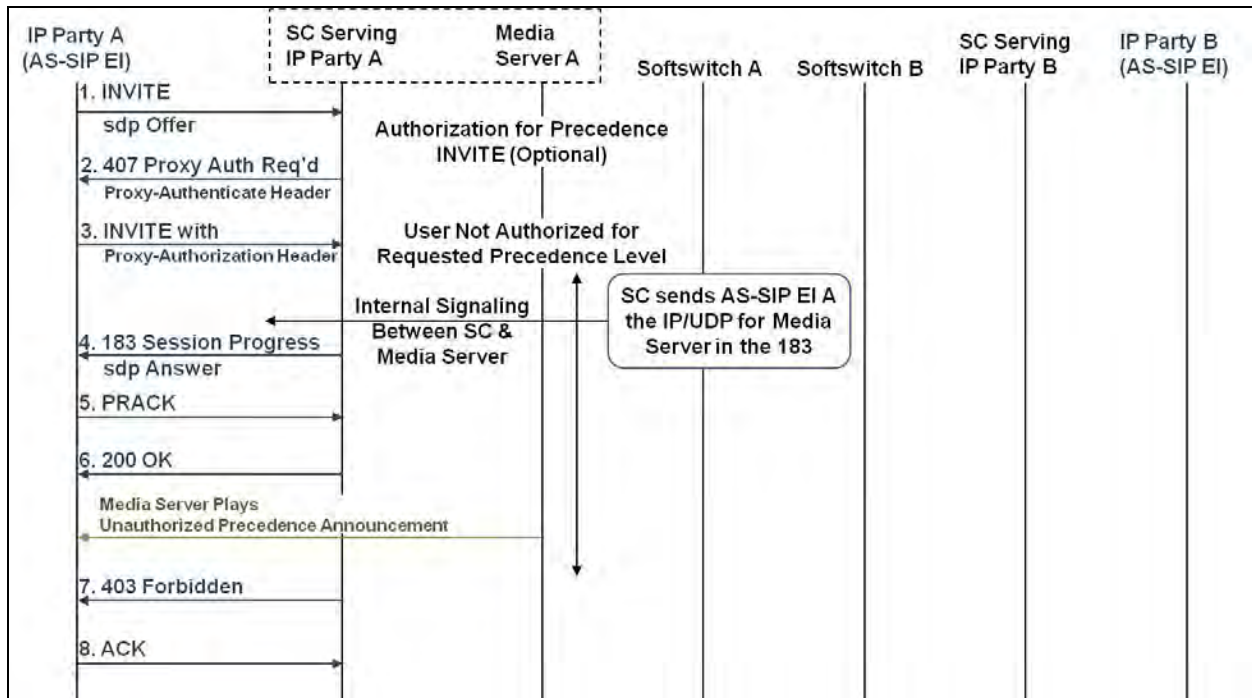

Figure 6.1-1. SC/Media Server Plays UPA to AS-SIP EI (with P&P)

6.1.4.7 Insufficient Resources

SIP-004760 If an SC receives an inbound ROUTINE call request over the IP network for a served EI and the SC has insufficient bandwidth-related resources (e.g., due to call count threshold) to handle the call request, the SC MUST reply with a 488 (Not Acceptable Here) response code and MUST include a Warning header with the warning code 370 (Insufficient Bandwidth).

SIP-004770 If an SC receives an inbound precedence call request (i.e., with precedence level PRIORITY or above) over the IP network for a served EI and the SC has insufficient bandwidth-related resources (e.g., due to call count threshold) to handle the call request, and if there are insufficient existing calls (and/or call requests) of lower precedence where their removal would provide the necessary resources to support the pending call request, then:

SIP-004770.a The SC MUST reply with a 488 (Not Acceptable Here) response code and MUST include a Warning header with warning code 370 (Insufficient Bandwidth), and

SIP-004770.b The SC serving the calling IP EI MUST arrange for a BPA (see [Table 6.1-3](#), Announcements) to be played and/or displayed to the user through the calling IP EI.

SIP-004780 [Required: AS-SIP EI with P&P] In the case of a served AS-SIP EI, the SC serving the calling AS-SIP EI receives the 488 (Not Acceptable Here) response (that includes the Warning header with warning code 370 (Insufficient Bandwidth)) from the remote side and establishes a bearer connection between the AS-SIP EI and a media server associated with the SC. Please see [Figure 6.1-2](#), SC Implementation of BPA for AS-SIP EI on Receipt of 488 Response. The SC and media server exchange the necessary signaling to provide the media server with the IP address and UDP port for the bearer stream with the AS-SIP EI and the SC instructs the media server to play the BPA over the bearer stream to the AS-SIP EI after the bearer is established. The 183 (Session Progress) response sent by the SC to the AS-SIP EI includes the sdp answer with the IP address and UDP port for a bearer stream with the media server. The AS-SIP EI responds with a PRACK to which the SC responds with a 200 (OK) response. The media server plays the announcement to the AS-SIP EI and terminates the session with the SC, and the SC sends a 488 (Not Acceptable Here) response (that includes the Warning header with warning code 370 (Insufficient Bandwidth)) to the AS-SIP EI. The AS-SIP EI responds with an ACK and terminates the call request.

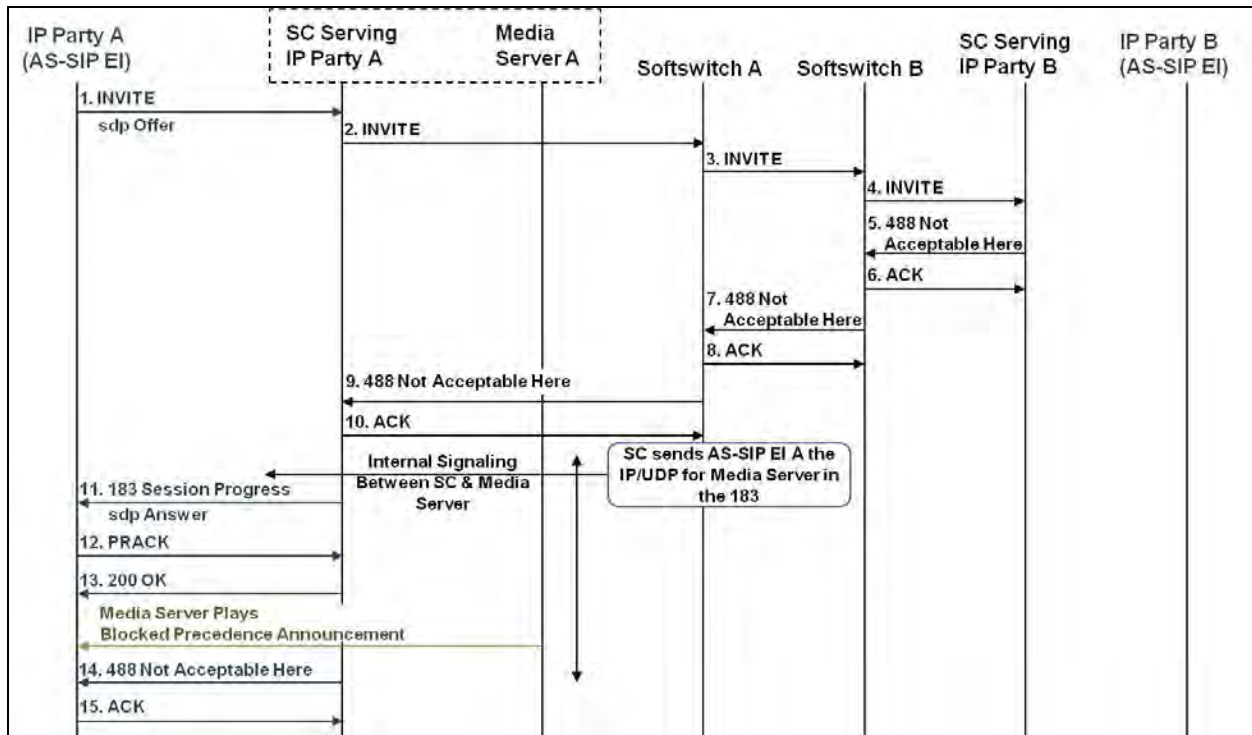

Figure 6.1-2. SC Implementation of BPA for AS-SIP EI (with P&P) on Receipt of 488 Response

NOTE: The media server is considered a part of the SC SUT; therefore, the signaling between the SC and media server is left to the vendor as long as the announcement

is played and the signaling between the SC and AS-SIP EI complies with the specific call flow depicted in this section.

NOTE: In the case of a routine INVITE (as opposed to a precedence INVITE) the 488 (Not Acceptable Here) response is forwarded all the way to the AS-SIP EI since there will be no BPA announcement. The AS-SIP EI would respond with an ACK and terminate the call request.

SIP-004790 If an AS-SIP signaling appliance receives a call request and has insufficient server resources to handle the signaling load, then the AS-SIP signaling appliance MUST reply with a 503 (Service Unavailable) response code. The SC serving the calling IP EI MUST arrange for an ICA³¹ (see [Table 6.1-3](#), Announcements) to be played and/or displayed to the user through the calling IP EI.

SIP-004800 In the case of a served AS-SIP EI, the SC serving the calling AS-SIP EI receives the 503 (Service Unavailable) response from the remote side and establishes a bearer connection between the AS-SIP EI and a media server associated with the SC. Please see [Figure 6.1-3](#), SC Implementation of ICA for AS-SIP EI on Receipt of 503 Response. The SC and media server exchange the necessary signaling to provide the media server with the IP address and UDP port for the bearer stream with the AS-SIP EI, and the SC instructs the media server to play the ICA over the bearer stream to the AS-SIP EI after the bearer is established. The 183 (Session Progress) response sent by the SC to the AS-SIP EI includes the sdp answer with the IP address and UDP port for a bearer stream with the media server. The AS-SIP EI responds with a PRACK to which the SC responds with a 200 (OK) response. The media server plays the announcement to the AS-SIP EI and terminates the session with the SC, and the SC sends a 503 (Service Unavailable) response to the AS-SIP EI. The AS-SIP EI responds with an ACK and terminates the call request.

NOTE: The media server is considered a part of the SC SUT; therefore, the signaling between the SC and media server is left to the vendor as long as the announcement is played and the signaling between the SC and AS-SIP EI complies with the specific call flow depicted in this section.

³¹ In UCR 2008, Change 2, the requirements incorrectly specified BPA to be played on the receipt of the 503 response. The BPA announcement will remain acceptable for 18 months from the release of UCR 2008, Change 3.

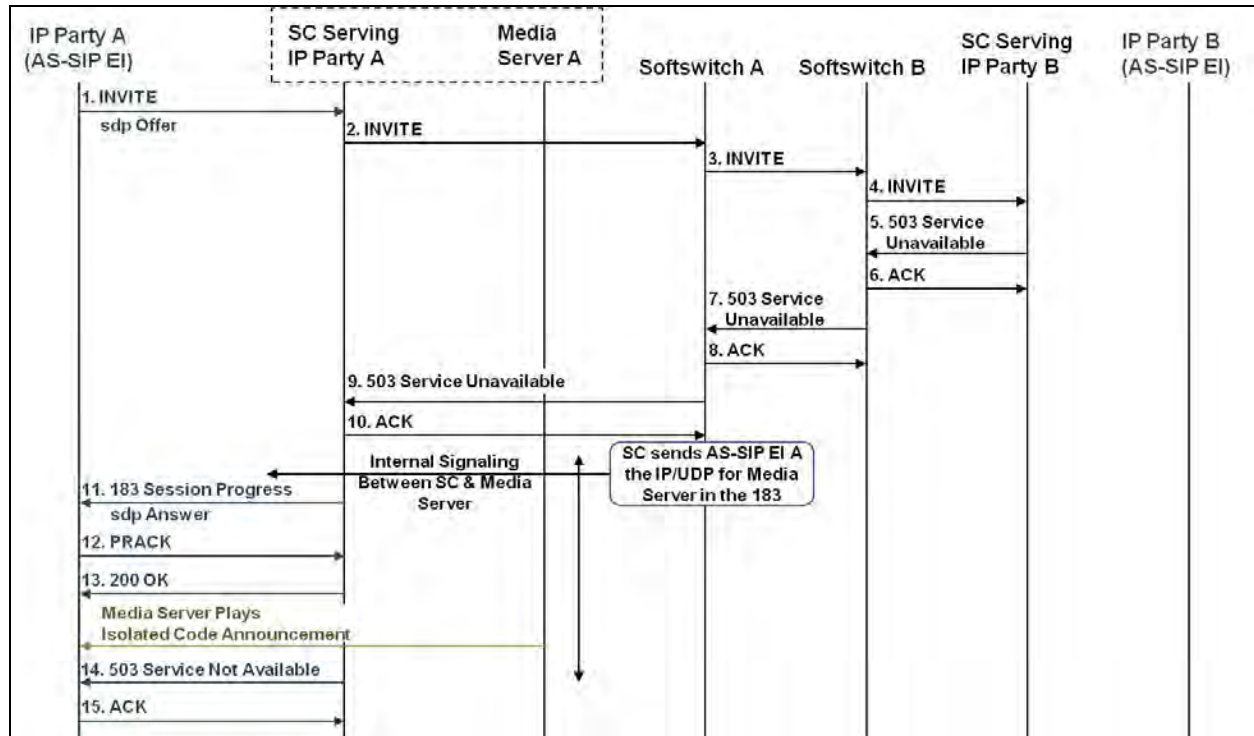

Figure 6.1-3. SC Implementation of ICA for AS-SIP EI on Receipt of 503 Response

6.1.4.8 Re-INVITE With Different Resource-Priority Header

6.1.4.8.1 Two-Party Call

SIP-004810 In the case of a two-party call, the Resource-Priority header of a re INVITE or UPDATE MUST be identical to that of the original INVITE. The network-domain field MUST be identical, the r-priority value MUST be identical, and the precedence-domain field MUST be identical.

SIP-004820 Each SC MUST ensure that any re-INVITE or UPDATE originated either by the SC itself or by a served AS-SIP EI with P&P has a Resource-Priority header where the namespace and r-priority value are identical to that of the original INVITE UNLESS the re-INVITE or UPDATE is covered by one of the following multiparty call exceptions:

SIP-004820.a In the event that an SC receives a re-INVITE or UPDATE from a served AS-SIP EI with P&P having a Resource-Priority header where the namespace or r-priority value is different from that of the original INVITE (and the re INVITE or UPDATE is NOT covered by one of the following multiparty exceptions), then the SC MUST correct the Resource-Priority header so that it is identical to that of the original INVITE before sending the re-INVITE or UPDATE to the SS.

6.1.4.8.2 *Multiparty Call Instances of Re-INVITE With Different Resource-Priority Header*

SIP-004830 (Unattended Transfer using Re-INVITE Method) In the case of an unattended transfer in which the call between the transferee and transferor has a different priority from the INVITE sent by the transferor to the transfer target, a transferor SC using the re-INVITE method MUST ensure that the final priority of the call has the higher of the two priority levels. This means that the transferor SC MUST place a different priority in the r-priority field in the Resource-Priority header of re-INVITES and UPDATES sent to the lower priority call than was present in the original INVITE for that call.

SIP-004840 (Attended Transfer using Re-INVITE Method) In the case of an attended transfer in which the call between the transferee and transferor has a different priority from the call between the transferor and the transfer target, a transferor SC using the re INVITE method MUST ensure that the final priority of the call has the higher of the two priority levels. This means that the transferor SC MUST place a different priority in the r-priority field in the Resource-Priority header of re-INVITES and UPDATES sent to the lower priority call than was present in the original INVITE for that call.

6.1.4.8.3 *Receiving a Re-INVITE With a Different Value for r-priority Field*

SIP-004850 An SC that receives an inbound re-INVITE or UPDATE (from the UC WAN) intended for a served EI that has a different priority level from the initial INVITE MUST accept the validity of the change to the priority level and use the new priority level in subsequent INVITES and UPDATES.

SIP-004860 **[Required: AS-SIP EI with P&P]** An AS-SIP EI that receives an inbound re-INVITE or UPDATE (from its SC) that has a different priority level from the initial INVITE MUST accept the validity of the change to the priority level and use the new priority level in subsequent INVITES and UPDATES.

SIP-004870 When an SS receives a re-INVITE or UPDATE from another AS-SIP signaling appliance (i.e., SC or SS) that changes the priority level of a call, then the SS MUST update the priority level of the call in the state information the SS maintains on the call.

6.2 PRECEDENCE CALL RULES

SIP-004880 When a precedence call (i.e., Priority or higher) is offered successfully to a called party, the calling party MUST receive an audible ringback precedence call tone. See [Table 6.2-1](#), UC Information Signals, for details on audible ringback precedence call tone.

Table 6.2-1. UC Information Signals

SIGNAL	FREQUENCIES (HZ)	SINGLE TONE LEVEL	COMPOSITE LEVEL	INTERRUPT RATE	TONE ON	TONE OFF
Audible Ringback Precedence Call	440 + 480 (Mixed)	-19 dBm0	-16 dBm0	30 IPM	1640 ms	360 ms
Alerting (Ring) Routine	-	-	-	10 IPM	2000 ms	4000 ms
Alerting (Ring) Precedence	-	-	-	30 IPM	1640 ms	360 ms
Preemption Tone	440 + 620 (Mixed)	-19 dBm0	-16 dBm0		Steady on	
Call Waiting (Precedence Call)	440	-13 dBm0		Continuous at 6 IPM	100 ± 20 ms Three Bursts	9700 ms
Conference Disconnect Tone	852 and 1336 (alternated at 100 ms Intervals)	-24 dBm0		Steady on	2000 ms (per occurrence)	
Override Tone	440			Continuous at 6 IPM	2000 ms (followed by) 500 ms on and 7500 ms off	
Camp On	440	-13 dBm0			Single burst 0.75 to 1 second	

6.2.1 AS Precedence Capability and Call Forwarding

SIP-004890 In the case of an IP EI for which the user has NOT activated call forwarding, when a precedence call is not answered within a predetermined period of between 15–45 seconds and precedence call waiting has not been accepted, then the SC serving the IP EI MUST provide a global default diversion to the Attendant.

SIP-004900 In the case of an IP EI for which the user has NOT activated call forwarding, when a precedence call request is sent to an IP EI that is busy with a higher precedence call, the precedence call waiting MUST be invoked whereby the precedence call waiting tone is applied to the called party. See [Table 6.2-1](#), UC Information Signals.

SIP-004900.a If, after receiving the precedence call waiting signal, the busy called IP EI does not answer the incoming call within the maximum programmed time interval, the SC serving the IP EI MUST provide a global default diversion to the Attendant.

NOTE: If for some reason the IP EI does NOT support call waiting, then the precedence call request MUST be diverted to the Attendant.

SIP-004910 In the case of an IP EI for which the user has NOT activated call forwarding, when a precedence call request is sent to an IP EI that is busy with a call of equal precedence to the

new call request, then the precedence CW tone MUST be applied to the called party. See [Table 6.2-1](#), UC Information Signals.

SIP-004910.a If, after receiving the precedence CW signal, the busy called IP EI does not answer the incoming call within the maximum programmed time interval, the SC serving the IP EI MUST provide a global default diversion to the Attendant.

NOTE: If for some reason the IP EI does NOT support CW, then the precedence call request MUST be diverted to the attendant.

SIP-004920 In the case of an IP EI for which the user has NOT activated Call Forwarding (CF), if a precedence call is sent to an IP EI that is busy with a lower precedence call, then the existing lower precedence call MUST be preempted and the incoming call shall be established.

SIP-004930 When CF is activated SCs MUST perform CF for routine calls.

SIP-004940 The SC support for AS precedence capability interaction with CF is a conditional requirement.

SIP-004940.a The SCs that do not support AS precedence capability interaction with CF for precedence calls MUST NOT perform CF of precedence calls. (see Requirements SIP-004970 and SIP-005000)

SIP-004940.b The SCs that support AS precedence capability interaction for precedence calls MUST comply with Requirements SIP-004860, SIP-004860.a, SIP-004860.b, SIP-004980, and SIP-004990.

SIP-004950 In the case of an IP EI for which the user has activated CF busy, if a precedence call is sent to an IP EI that is busy with a lower precedence call (or calls, if three-way calling is established), then the existing call (or three-way call) at the busy station MUST be preempted and the incoming call established, i.e., the CF service shall not be invoked.

SIP-004960 In the case of an IP EI for which the user has activated CF busy and the serving SC is compliant to the AS precedence capability interaction requirements for CF defined in UCR 2013, Section 2.2.1, Call Forwarding, when a precedence call is sent to an IP EI that is busy with a higher or equal precedence call or calls, then the CF service MUST be invoked.

SIP-004960.a The precedence level of calls is preserved during the forwarding process, and the forwarded-to user may be preempted.

SIP-004960.b If CFB has been activated by the called party and the called party has specified a forwarded-to party and the serving SC is compliant to the Multilevel Precedence and Preemption (MLPP) interaction requirements for CF as defined in UCR 2013, Section 2.2.1, Call Forwarding, then the forwarding procedure MUST be performed. If a precedence call is forwarded (including possible multiple forwarding) and is not responded to by any forwarded-to party (e.g., called party busy with a call of equal

or higher precedence level; or called party busy and nonpreemptable) within a specified period (typically 30 seconds), the SC serving the called party shall divert the precedence call to the attendant.

SIP-004970 In the case of an IP EI for which the user has activated CFB and the serving SC is NOT compliant to the MLPP interaction requirements for CF, as defined in UCR 2013, Section 2.2.1, Call Forwarding, when a precedence call is sent to an IP EI that is busy with a higher or equal precedence call or calls, the CF service SHALL not be invoked. In this case, rather than invoking the CF service, the precedence CW tone shall be applied to the called party. If, after receiving the precedence CW signal, the busy called IP EI does not answer the incoming call within the maximum programmed time interval, the SC serving the IP EI MUST provide a global default diversion to the attendant.

SIP-004980 In the case of an IP EI for which the user has activated CF on no answer and the serving SC is compliant to the MLPP interaction requirements for CF, as defined UCR 2013, Section 2.2.1, Call Forwarding, then the precedence level of calls MUST be preserved during the forwarding process, and then forwarded to user may be preempted.

SIP-004990 In the case of an IP EI for which the user has activated CF on no answer and has specified a forwarded-to party and the SC is compliant to the MLPP interaction requirements for CF, as defined in UCR 2013, Section 2.2.1, Call Forwarding, then the forwarding procedure MUST be performed. If a precedence call is forwarded (including possibly multiple forwarding) and is not responded to by any forwarded-to party (e.g., called party busy with a call of equal or higher precedence level; or called party busy and nonpreemptable) within a specified period (typically 30 seconds), the SC serving the called party shall divert the precedence call to the attendant.

SIP-005000 In the case of an IP EI for which the user has activated CF on no answer, but the serving SC is NOT compliant to the MLPP interaction requirements for CF, as defined in UCR 2013, Section 2.2.1, Call Forwarding, when a precedence call is sent to the EI, the CF service SHALL not be invoked. When the precedence call is not answered within a predetermined period of between 15–45 seconds, the SC serving the IP EI MUST provide a global default diversion to the attendant.

6.3 CALL ORIGINATION BUSY

SIP-005010 Whenever there is only one appearance remaining on an EI and a user initiates the sequence of events to make an outbound call (e.g., goes off-hook, or inputs the first dialing digit, or invokes the telephony communication program and selects the number to dial on a telephony computer screen), then:

SIP-005010.a In the event of an inbound routine call request, the inbound call request will be rejected. In the case of a proprietary IP EI a 486 (Busy Here) response will be sent back to the originating AS-SIP signaling appliance. In the case of an AS-SIP EI with P&P, the AS-SIP EI MUST generate and send the 486 (Busy Here) response. In the case

of a RO AS-SIP EI, the AS-SIP EI MUST generate and send a 480 (Temporarily Unavailable).

SIP-005010.b In the event of an inbound precedence call request where the precedence level is higher than that of an existing call on at least one occupied appearance, then an EI that supports endpoint preemption shall conduct the standard endpoint preemption process on the lowest such occupied appearance.³²

SIP-005010.c In the event of an inbound precedence call request where the precedence level is lower than or equal to all existing occupied appearances on the EI, or in the event the EI only has one appearance, then an EI that supports endpoint preemption SHALL implement one of the following two alternatives³³:

SIP-005010.c.1 Alternative 1: Refrain from acting on the inbound request until the user either has completed the dialing sequence for the outbound call or at least completed input of the precedence level information for the outbound call request so that the priority level of the outbound call request can be compared to the priority level of the inbound call request.

SIP-005010.c.1.a If the inbound precedence call request has a higher priority than the outbound call request, then the inbound call request will preempt the outbound call request as follows:

- If the outbound request is routine, then a preemption tone is played to the caller for 3 seconds and the outbound call request terminates. When the caller goes on-hook, the precedence ringing tone is played to alert the called party to the inbound precedence call request.
- If the outbound request is a precedence call, then a BPA is played to the caller; and when the caller goes on-hook, the precedence ringing tone is played to alert the called party to the inbound precedence call request.

SIP-005010.c.1.b If the inbound precedence call request has a priority less than or equal to the outbound request, then the outbound call request will proceed, and upon successful establishment of the outbound call, the subsequent called party actions shall be as specified in Requirement SIP-004890 or SIP-004900, or SIP-004910, or SIP-004950, as appropriate.

SIP-005010.c.1.b.1 If the outbound precedence call cannot be successfully established, then upon termination of the attempted outbound call request (e.g., caller goes on-hook), a precedence

³² A RO AS-SIP EI does not support endpoint preemption and will reject the inbound call request with a 480 Temporarily Unavailable.

³³ A RO AS-SIP EI does not support endpoint preemption and will reject the inbound call request with a 480 Temporarily Unavailable.

ringing tone will be played to alert the called party of the inbound precedence call request.

SIP-005010.c.2 Alternative 2: In the case of a proprietary IP EI theThe inbound precedence call request is sent to the global default diversion number. In the case of an AS-SIP IP EI with P&P the inbound precedence INVITE is rejected with a 486 (Busy Here) and the SC ACKs the 486 and diverts the precedence INVITE to the global default diversion number.

6.4 ASAC PREEMPTION REQUIREMENTS

If a session has to be preempted to support a higher precedence session, the use of the Reason header shall be IAW RFC 4411 and RFC 3326, as modified in this section to include a fifth Reason-param “Network Preemption.”

Preemption can only take place for sessions of the same precedence domain. In other words, a precedence call request can only preempt an existing call or call request that has the same value for its precedence-domain subfield.

6.4.1 Reason Header for Preemption

SIP-005020 The AS-SIP signaling appliances and AS-SIP EIs with P&P MUST support the Reason header field [RFC 3326] for use, at a minimum, with the BYE request, the CANCEL request, the 480 (Temporarily Unavailable) response, 486 (Busy Here) response, and the 488 (Not Acceptable Here) response.

SIP-005030 The syntax for the Reason header field is found in RFC 3326, Section 2, The Reason Request Header Field, and is repeated here for the reader’s convenience:

Reason	=	“Reason” HCOLON reason-value *(COMMA reason-value)
reason-value	=	protocol *(SEMI reason-params)
protocol	=	“SIP”/ “Q.850”/ token
reason-params	=	protocol-cause/ reason-text/ reason-extension
protocol-cause	=	“cause” EQUAL cause
cause	=	1*DIGIT
reason-text	=	“text” EQUAL quoted-string
reason-extension	=	generic-param

SIP-005040 For purposes of preemption, AS-SIP signaling appliances MUST support the reason-value “Preemption” and the four Reason-params defined in RFC 4411, Section 5, Preemption Reason Header Cause Codes and Semantics.

Reason: preemption ;cause	=	1 ;text	=	“UA Preemption”
Reason: preemption ;cause	=	2 ;text	=	“Reserved Resources Preempted”
Reason: preemption ;cause	=	3 ;text	=	“Generic Preemption”
Reason: preemption ;cause	=	4 ;text	=	“Non-IP Preemption”

SIP-005050 In addition, as the current set of Reason-params in RFC 4411 fails to fully meet our needs, the AS-SIP signaling appliances MUST support a fifth Reason-param intended to characterize a network preemption event that occurs in the IP portion of the network but is not due to a RSVP preemption occurrence:

Reason: preemption; cause	=	5; text	=	“Network Preemption”
---------------------------	---	---------	---	----------------------

SIP-005060 Tactical AS-SIP signaling appliances have a further need to identify the AS-SIP signaling appliance (SC or SS) that conducts the network preemption and the AS-SIP signaling appliance located on the other side of the bandwidth constrained link. Therefore Tactical AS-SIP signaling appliances MUST support generating a reason-extension consisting of two generic parameters cca-id1 and cca-id2 as follows:

Reason: preemption; cause	=	5; text	=	“Network Preemption”; cca- id1=CCA-ID; <u>cca-id2=CCA-ID</u>
---------------------------	---	---------	---	---

where the parameter cca-id1 identifies the AS-SIP signaling platform (SC or SS) that is conducting the preemption and the parameter cca-id2 identifies the AS-SIP signaling platform (SC or SS) on the other side of the bandwidth constrained link.

SIP-005070 [Conditional] It is a conditional requirement for strategic AS-SIP signaling appliances to support generating the Reason-extension.

SIP-005080 Strategic and Tactical SCs MUST be capable of receiving and forwarding the reason-value “Preemption” that includes the reason extension:

Reason: preemption ;cause	=	5 ;text	=	“Network Preemption”; cca-id1=CCA-ID; cca-id2=CCA-ID
---------------------------	---	---------	---	---

SIP-005090 For purposes of preemption, Strategic and Tactical SCs MUST be capable of receiving/processing the reason-value “Preemption” that includes the reason extension:

Reason: preemption; cause = 5; text = "Network Preemption"; cca-id1=CCA-ID;
cca-id2=CCA-ID

SIP-005100 [Required: AS-SIP EI with P&P] For purposes of preemption, AS-SIP EIs MUST be capable of generating the reason-value "Preemption" and the Reason parameter:

Reason: preemption ;cause = 1; text = "UA Preemption

SIP-005110 [Required: AS-SIP EI with P&P] For purposes of preemption, AS-SIP EIs MUST be capable of receiving/processing the reason-value "preemption" with and without the reason-extension:

Reason: preemption ;cause = 1; text = "UA Preemption"

Reason: preemption ;cause = 2; text = "Reserved Resources Preempted"

Reason: preemption ;cause = 3; text = "Generic Preemption"

Reason: preemption ;cause = 4; text = "Non-IP Preemption"

Reason: preemption ;cause = 5; text = "Network Preemption"

Reason: preemption ;cause = 5; text = "Network Preemption"; cca-id1=CCA-ID;
cca-id2=CCA-ID

The appropriate usage of the preemption Reason parameters is described in the following paragraphs.

6.4.2 Preemption at the IP EI

6.4.2.1 General Preemption Rules for Behavior at IP EIs

SIP-005120 (See note in SIP-004390) When the precedence-domain subfield of the Resource-Priority header field of the incoming precedence call request is different from the precedence-domain of the existing call (or calls) at a proprietary IP EI, then the incoming precedence call request MUST not preempt an existing call. If all appearances at the proprietary IP EI are in use then the SC serving the called proprietary IP EI MUST provide a global default diversion to the Attendant.

NOTE: In the case of an incoming precedence call request intended for a served AS-SIP EI, the SC forwards the precedence request to the AS-SIP EI. When the precedence-domain subfield of the Resource-Priority header field of the incoming precedence call request is different from the precedence-domain of the existing call (or calls) at an AS-SIP EI with P&P then the AS-SIP EI with P&P must not preempt an existing call. If all appearances at the AS-SIP EI are in use then the AS-SIP EI can either provide no response in which case the SC will divert the call to the attendant after a configurable time interval or respond with a 486 Busy Here and the SC will ACK

the 486 response and divert the precedence INVITE to the attendant. In the case of a RO AS-SIP EI if all appearances at the RO AS-SIP EI are in use then the RO AS-SIP EI will either play call waiting and if there is no response within a configurable time interval the SC will divert the precedence INVITE to the attendant or the RO AS-SIP EI will respond with a 480 Temporarily Unavailable in which case the SC will Ack the response and divert the call to the attendant.

SIP-005130 When a precedence call request is sent to an SC and intended for a served non-preemptable IP EI³⁴ that is busy with another call, then the SC serving the called IP EI MUST provide a global default diversion to the Attendant. In the event the call request cannot be directed to the attendant and is rejected, then the response will be a 480 (Temporarily Unavailable) response with either no Reason header or a Reason header that does NOT have a preemption cause.

NOTE: When the SC serving the calling IP EI receives the 480 (Temporarily Unavailable) response, it MUST send a BNEA, and then a termination message to the served calling IP EI.

NOTE: In the case of a served AS-SIP EI, the SC serving the calling AS-SIP EI receives the 480 (Temporarily Unavailable) response from the remote side and establishes a bearer connection between the AS-SIP EI and a media server associated with the SC. Please see [Figure 6.4-1](#), SC Implementation of BNEA for AS-SIP EI on Receipt of 480 Response. The SC and media server exchange the necessary signaling to provide the media server with the IP address and UDP port for the bearer stream with the AS-SIP EI and the SC instructs the media server to play the BNEA over the bearer stream to the AS-SIP EI after the bearer is established. The 183 (Session Progress) response sent by the SC to the AS-SIP EI includes the sdp answer with the IP address and UDP port for a bearer stream with the media server. The AS-SIP EI responds with a PRACK to which the SC responds with a 200 (OK) response. The media server plays the announcement to the AS-SIP EI and terminates the session with the SC, and the SC sends a 480 BNEA to the AS-SIP EI. The AS-SIP EI responds with an ACK and terminates the call request.

NOTE: The media server is considered a part of the SC SUT; therefore, the signaling between the SC and media server is left to the vendor as long as the announcement is played and the signaling between the SC and AS-SIP EI complies with the specific call flow depicted in this section.

³⁴ A non-preemptable IP EI is an IP EI that does not support preemption. There is no requirement to be capable of provisioning an IP EI as non-preemptable and non-preemptable IP EIs are, in fact, discouraged.

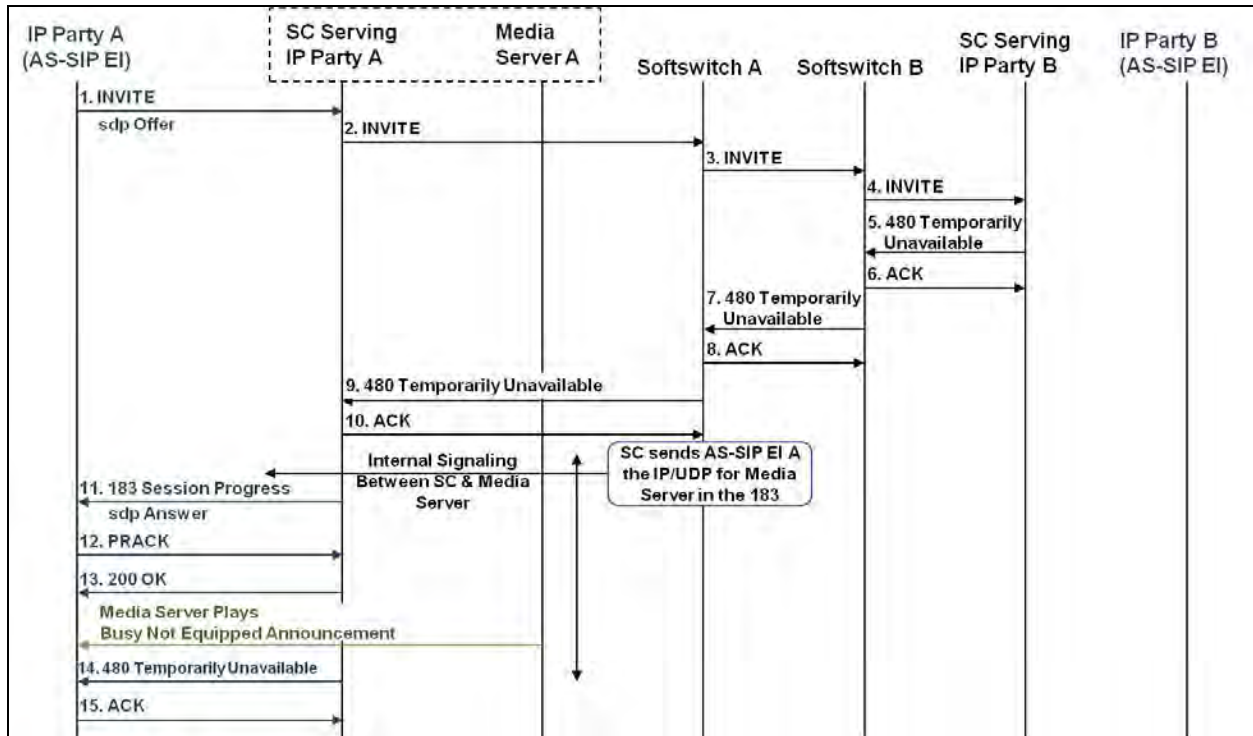

Figure 6.4-1. SC Implementation of BNEA for AS-SIP EI on Receipt of 480 Response

For completeness, when an SC serving a calling IP EI receives an inbound 486 (Busy Here) or a 488 (Not Acceptable Here) response code to an initial precedence INVITE (see [Section 6.4.3](#), Network Preemption) with either no Reason header or a Reason header that does NOT have a preemption cause then the SC MUST send a BPA to the served calling IP EI, and then send a termination message to end the call request.

NOTE: In the case of a served AS-SIP EI, when the SC serving the calling AS-SIP EI receives a 486 (Busy Here) or a 488 (Not Acceptable Here) response code to an initial INVITE (see [Section 6.4.3](#), Network Preemption) with either no Reason header or a Reason header that does NOT have a preemption cause for an outbound precedence call request from the remote side, then the SC establishes a bearer connection between the AS-SIP EI and a media server associated with the SC. Please see [Figure 6.4-2](#), SC Implementation of BPA for AS-SIP EI on Receipt of 486, or 488 Response. The SC and media server exchange the necessary signaling to provide the media server with the IP address and UDP port for the bearer stream with the AS-SIP EI and the SC instructs the media server to play the BPA over the bearer stream to the AS-SIP EI after the bearer is established. The 183 (Session Progress) response sent by the SC to the AS-SIP EI includes the sdp answer with the IP address and UDP port for a bearer stream with the media server. The AS-SIP EI responds with a PRACK to which the SC responds with a 200 (OK) response. The media server plays the announcement to the AS-SIP EI and terminates the session

with the SC, and the SC sends a 486, or 488 (Not Acceptable Here) response to the AS-SIP EI. The AS-SIP EI responds with an ACK and terminates the call request.

NOTE: The media server is considered a part of the SC SUT; therefore, the signaling between the SC and media server is left to the vendor as long as the announcement is played and the signaling between the SC and AS-SIP EI complies with the specific call flow depicted in this section.

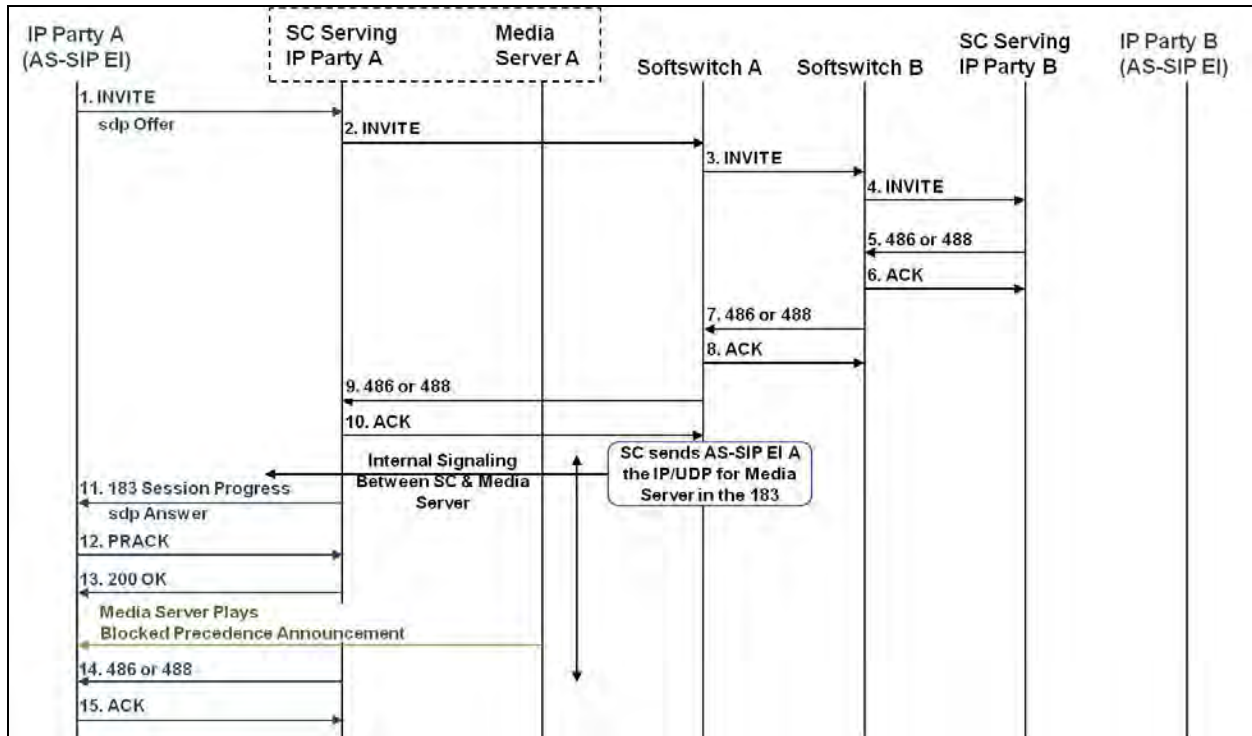

Figure 6.4-2. SC Implementation of BPA for AS-SIP EI on Receipt of 486, or 488 Response

SIP-005140 When a precedence call request is sent to a preemptable IP EI that is busy with a call of lower precedence (having no idle appearances and having the same value for the precedence-domain subfield), then the lower precedence call MUST be preempted (regardless of whether the lower precedence call and the new higher precedence call request are of the same media type. In other words, in endpoint preemption, a lower precedence audio call will be preempted by a higher precedence audio call request or a higher precedence video call request, and a lower precedence video session will be preempted by a higher precedence video session request or a higher precedence audio call request.) The active busy IP EI MUST receive a continuous preemption tone until an on-hook signal is received and the other party shall receive a preemption tone for a minimum of 3 seconds. After going on hook, the station to which the precedence call is directed MUST be provided with precedence ringing and the calling party MUST receive an audible ringback precedence tone. When the called IP EI goes back off-hook, it MUST be connected to the preempting call. (Details of this scenario are described in, [Section 6.4.2.2](#), Required Behavior at Called IP EI When Active Call Is Preempted by Higher

Precedence Call Request). See [Table 6.2-1](#), UC Information Signals, for details on the preemption tone, ringing signal, and the audible ringback precedence call tone.

SIP-005150 Whenever an SC performs an endpoint preemption of an existing call for a served IP EI, the SC MUST NOT consider the existing call to be terminated until the SC has received an acknowledgement from its local IP EI that the call has been terminated and until the SC has received a 200 (OK) response to the BYE request sent to the remote SC serving the remote IP EI where the call is being preempted.

NOTE: In the case of an AS-SIP EI, the SC MUST NOT perform endpoint preemption, rather it MUST forward the precedence INVITE to the AS-SIP EI, ~~and the AS-SIP EI conducts the endpoint preemption. The AS-SIP EI with P&P will perform endpoint preemption (if necessary). The RO AS-SIP EI will process the new precedence INVITE as a routine INVITE and is not capable of performing endpoint preemption~~³⁵.

SIP-005160 Whenever an SC performs an endpoint preemption of an inbound call request for a served IP EI, the SC MUST NOT consider the existing call request to be terminated until the SC has received an acknowledgement from its local IP EI that the call has been terminated and until the SC has received an ACK to the 486 (Busy Here) response code (which has a Reason header where the Reason-params has the value `preemption;cause=1;text="UA Preemption"`) sent to the remote SC serving the remote IP EI that has the call being preempted.

NOTE: If the local SIP EI is RFC 2543 compliant but not RFC 3261 compliant, it will not send a 487 (Request Terminated) response and the local SC will consider the call leg with the local SIP EI terminated upon receipt of the 200 (OK) response to the CANCEL.

SIP-005170 Whenever an SC performs an endpoint preemption of an outbound call request for a served IP EI, the SC MUST NOT consider the existing call request to be terminated until the SC has received an acknowledgement from its local IP EI that the call has been terminated and has received a 200 (OK) response to the BYE request, or a 200 (OK) response to a CANCEL request from the remote SC serving the remote IP EI that has the call being preempted.

NOTE: Since RFC 2543-compliant SIP appliances do not send a 487 (Request Terminated) response if the local SC were to wait for a 487 response from the far end that is not being sent, the delay until the call could be considered technically to have been cancelled is $64 * T1$ seconds (where $T1$ is defined in RFC 3261, Section 17.1.1.1, Overview of INVITE Transaction). Hence, we will consider the call terminated upon the receipt of the 200 (OK) response.

³⁵ If the RO AS-SIP EI has idle appearances then the AS-SIP EI will play a ringing tone on an idle appearance; if there are no idle appearances then the RO AS-SIP EI will either play the call waiting tone or reject the call with a 480 (Temporarily Unavailable).

6.4.2.2 *Required Behavior at Called IP EI When Active Call Is Preempted by Higher Precedence Call Request*

6.4.2.2.1 *SC Preempts Active Call on Behalf of Served IP EI (Other Than an AS-SIP EI)*

NOTE: If the precedence INVITE is intended for a served AS-SIP EI, then the SC MUST forward the incoming precedence INVITE to the AS-SIP EI, and the AS-SIP EI will conduct the endpoint preemption. The AS-SIP EI with P&P will perform endpoint preemption (if necessary). The RO AS-SIP EI will process the new precedence INVITE as a routine INVITE and is not capable of performing endpoint preemption³⁶.

SIP-005180 Whenever an SC receives a call request intended for a served IP EI (other than an AS-SIP EI) that has one line active with a call that is of lower precedence than the incoming call request (and has no idle appearances), then the active call MUST be preempted IAW [Section 6.4.2.3](#), Implementing Preemption on Behalf of Called IP End Instruments.

6.4.2.2.2 *AS-SIP EI Preempts Active Call*

SIP-005190 [Required: AS-SIP EI with P&P] Whenever an AS-SIP EI has a line active with a call that is of lower precedence than an incoming precedence call request (and has no idle appearances), then the active call MUST be preempted IAW [Section 6.4.2.3](#), Implementing Preemption on Behalf of Called IP End Instruments.

6.4.2.2.3 *Multiple Appearances*

SIP-005200 The IP EIs MUST be limited to two appearances per directory number and limited to, at most, two directory numbers.

SIP-005210 Whenever an SC receives a precedence INVITE intended for a served IP EI that has multiple appearances and one directory number, or whenever a precedence INVITE is received by an AS-SIP EI with P&P that has multiple appearances and one directory number, then:

SIP-005210.a If the incoming call request has a higher precedence than an existing call and there is at least one call appearance not in use, then a precedence ringing tone MUST be provided on an unused call appearance. The called party has the option of placing the current call on hold and picking up the incoming precedence call or ignoring the call. The calling party MUST be provided with an audible ringback precedence call tone (see [Table 6.2-1](#), UC Information Signals).

³⁶ If the RO AS-SIP EI has idle appearances then the AS-SIP EI will play a ringing tone on an idle appearance; if there are no idle appearances then the RO AS-SIP EI will either play the call waiting tone or reject the call with a 480 (Temporarily Unavailable).

SIP-005210.b If the incoming call request has a higher precedence (and the same value for the precedence-domain subfield)³⁷ than one or more existing calls (even existing calls that are on hold) but all call appearances are in use, then the existing lowest precedence call is preempted. The lowest precedence call MUST be preempted regardless of whether the lowest precedence call and the new higher precedence call request are of the same media type; in other words, a lowest precedence audio call is preempted by a higher precedence audio call request or a higher precedence video call request and the lowest precedence video session is preempted by a higher precedence video session request or a higher precedence audio call request.

SIP-005210.c When the existing lowest precedence call is a held call, then a preemption tone is sent to both the held caller and to the corresponding appearance on the IP EI of the destination directory number that has placed the call on hold. After a preset time, the held call is cleared and a precedence ring is provided to the corresponding appearance on the destination directory number of the IP EI. The user hears the precedence ringing, indicating that the call on hold has been dropped. The user also sees the precedence level of this new call on the station set display. The user has the option of answering the call, letting it forward to an alternate party, and/or letting it divert to an attendant. The calling party MUST be provided with an audible ringback precedence call tone (see [Table 6.2-1](#), UC Information Signals).

SIP-005210.d When an existing active call has the lowest precedence, a preemption tone is sent to the remote party for a minimum of 3 seconds and a preemption tone is played on the destination directory number. When the user goes on-hook, a precedence ring is received indicating the incoming precedence call. The calling party MUST be provided with an audible ringback precedence call tone (see [Table 6.2-1](#), UC Information Signals).

SIP-005220 Whenever an SC receives a precedence INVITE intended for a served proprietary IP EI that has multiple appearances and one directory number AND all appearances are in use (active or on hold) with calls having higher or equal priority to the incoming precedence request, then the precedence request is diverted to an attendant.

SIP-005225 When an SC receives an INVITE (routine or precedence) intended for a served AS-SIP EI that has one directory number the SC forwards the INVITE to the AS-SIP EI.³⁸

SIP-005230 Whenever an SC receives a precedence INVITE intended for a served proprietary IP EI that has multiple appearances and two directory numbers or whenever a precedence INVITE is received by an AS-SIP EI [with P&P](#) that has multiple appearances and two directory numbers, then the preemption behavior for each directory number and its multiple appearances is the same

³⁷ There is currently only one valid value for the precedence-domain subfield (i.e., “000000”); therefore, for purposes of UCR 2013, the value of the precedence-domain subfield will never prevent the higher precedence inbound call request from preempting an existing lower precedence call at the EI.

³⁸ It is not assumed that the SC is apprised of the number [if-of](#) available appearances at a AS-SIP EI.

as described previously in Requirement SIP-005210 for a proprietary IP EI that has multiple appearances and one directory number.

SIP-005235 When an SC receives an INVITE (routine or precedence) intended for a served AS-SIP EI that has two directory numbers the SC forwards the INVITE to the AS-SIP EI.

6.4.2.3 Implementing Preemption on Behalf of Called IP EIs

6.4.2.3.1 Endpoint Preemption of an Active Call

6.4.2.3.1.1 Endpoint Preemption of an Active Call Conducted by an SC on Behalf of a Served IP EI (Other Than an AS-SIP EI)

NOTE: If the precedence INVITE is intended for a served AS-SIP EI, then the SC MUST forward the incoming precedence INVITE to the AS-SIP EI, ~~and the AS-SIP EI will conduct the endpoint preemption~~ The AS-SIP EI with P&P will perform endpoint preemption (if necessary). The RO AS-SIP EI will process the new precedence INVITE as a routine INVITE and is not capable of performing endpoint preemption.

SIP-005240 Whenever an SC initiates an endpoint preemption of an active call on behalf of a called IP EI, then the SC MUST:

SIP-005240.a Activate user signaling (i.e., preemption tone) at the local IP EI where the existing call is being preempted.

SIP-005240.b Send a 180 (Ringing) response to the remote SC or remote AS-SIP EI with P&P responsible for the precedence call request that initiated the endpoint preemption.³⁹ The remote SC or remote AS-SIP EI with P&P will activate user signaling (i.e., precedence ringback tone) for the caller and the call setup for the precedence call request continues as usual.

SIP-005240.c Send a BYE request with a Reason header where the Reason-params has the value preemption ;cause=1 ;text="UA Preemption" over the IP network to the SC serving the remote IP EI that has the call being preempted or to the remote AS-SIP EI.

In the case of a remote proprietary IP EI theA remote SC MUST activate the preemption tone at the IP EI for at least 3 seconds, signal the IP EI that the session is being terminated, and send a 200 (OK) response to the SC that initiated the endpoint preemption.

In the case of aA remote AS-SIP EI with P&P the remote AS-SIP EI with P&P MUST activate the preemption tone for at least 3 seconds, send a 200 (OK) response over the network to the SC that initiated the endpoint preemption, and terminate the session.

³⁹ By definition a RO AS-SIP EI does not initiate precedence calls.

In the case of a remote RO AS-SIP EI the remote RO AS-SIP EI will send a 200 (OK) response over the network to the SC that initiated the endpoint preemption and terminate the session. The SC serving the local IP EI that is experiencing the IP endpoint preemption will receive a 200 (OK) response code.

SIP-005240.d When the local IP EI goes on-hook the SC activates user signaling (i.e., precedence ringing tone) at the local IP EI.

6.4.2.3.1.2 Endpoint Preemption of an Active Call Conducted by AS-SIP EI

SIP-005250 [Required: AS-SIP with P&P] Whenever an AS-SIP EI initiates an endpoint preemption of an active call, then the AS-SIP EI MUST:

SIP-005250.a [Required: AS-SIP with P&P] Activate user signaling (i.e., play preemption tone to the user of the AS-SIP EI).

SIP-005250.b [Required: AS-SIP with P&P] Send a 180 (Ringing) response to the remote SC or remote AS-SIP EI with P&P where its-whose precedence call request has initiated the endpoint preemption.⁴⁰ The remote SC or remote AS-SIP EI with P&P will activate user signaling (i.e., precedence ringback tone) for the caller.

SIP-005250.c [Required: AS-SIP with P&P] Send a BYE request with a Reason header where the Reason-params has the value preemption ;cause=1 ;text="UA Preemption" over the IP network to the remote SC serving the IP EI that has the call being preempted, or to the remote AS-SIP EI that has the call being preempted.

In the case of a remote proprietary IP EI theA remote SC MUST activate the preemption tone at the IP EI for at least 3 seconds, signal the IP EI that the session is being terminated, and respond with a 200 (OK) response.

In the case of a remote AS-SIP EI with P&P theA remote AS-SIP EI with P&P MUST activate the preemption tone for at least 3 seconds, respond with a 200 (OK) response to the AS-SIP EI that initiated the endpoint preemption, and terminate the session.

In the case of a remote RO AS-SIP EI the RO AS-SIP EI will respond with a 200 (OK) to the BYE and terminate the session.

SIP-005250.d [Required: AS-SIP with P&P] The AS-SIP EI that initiated the IP endpoint preemption will receive a 200 (OK) response code.

SIP-005250.e [Required: AS-SIP with P&P] When the local AS-SIP EI goes on-hook, the local AS-SIP EI activates user signaling (i.e., plays the precedence ringing tone).

⁴⁰ By definition a RO AS-SIP EI does not initiate precedence calls

6.4.2.3.2 Endpoint Preemption of an Inbound Call Request

6.4.2.3.2.1 Endpoint Preemption of an Inbound Call Request Conducted by an SC on Behalf of a Served IP EI (Other Than an AS-SIP EI)

SIP-005260 The SC has forwarded the INVITE (or equivalent signaling message) to the proprietary IP EI and may have received a 180 (Ringing) response (or equivalent) from the proprietary IP EI but has not received a 200 (OK) response (or equivalent) from the proprietary IP EI. Whenever an SC performs an endpoint preemption of an inbound call request on behalf of a called IP EI, then the SC MUST:

SIP-005260.a Send a termination message to the local IP EI to end the current inbound call request that is being preempted in favor of the new higher precedence call request. The termination message will terminate the ringing tone.

NOTE: There is no particular purpose to playing the preemption tone because the telephone is on-hook.

SIP-005260.b Send a 180 (Ringing) response to the remote SC or remote AS-SIP EI with P&P that initiated the higher precedence call request.⁴¹ The remote SC or remote AS-SIP EI with P&P will activate user signaling (i.e., precedence ringback tone) for the caller.

SIP-005260.c Send a 486 (Busy Here) response code and a Reason header where the Reason-params has the value preemption ;cause=1 ;text="UA Preemption" over the IP network toward the remote SC serving the IP EI that initiated the call request being preempted or toward the remote AS-SIP EI that initiated the call request being preempted.

In the case of a remote proprietary IP EI the remote SC will interrupt the user signaling (i.e., ringback) to the IP EI that has the call request being preempted, will activate a preemption tone for 3 seconds, terminate the session at the served IP EI, and send an ACK to the SC that initiated the endpoint preemption.

In the case of a remote AS-SIP EI with P&P the remote AS-SIP EI with P&P activates a preemption tone for 3 seconds, sends back an ACK, and terminates the session.

In the case of a remote RO AS-SIP EI the remote RO AS-SIP EI sends back an ACK and terminates the session.

SIP-005260.d The local SC will receive an ACK response to the 486 (Busy Here) response code.

SIP-005260.e The local SC will continue the call setup for the higher precedence call by activating user signaling (i.e., playing the precedence ringing tone).

⁴¹ By definition a RO AS-SIP EI does not initiate precedence calls.

6.4.2.3.2.2 Endpoint Preemption of an Inbound Call Request Conducted by AS-SIP EI

SIP-005270 [Required: AS-SIP EI with P&P] Whenever an AS-SIP EI performs an endpoint preemption of an inbound call request (e.g., the AS-SIP EI may have sent a 180 (Ringing) response but has not sent a 200 (OK) response), then the AS-SIP EI MUST:

SIP-005270.a [Required: AS-SIP EI with P&P] Terminate the ringing tone of the current inbound call request that is being preempted in favor of the new higher precedence call request.

NOTE: There is no particular purpose to playing the preemption tone because the telephone is on-hook.

SIP-005270.b [Required: AS-SIP EI with P&P] Send a 180 (Ringing) response to the remote SC or remote AS-SIP EI with P&P that initiated the higher precedence call request.⁴² The remote SC or remote AS-SIP EI with P&P will activate user signaling (i.e., precedence ringback tone) for the caller.

SIP-005270.c [Required: AS-SIP EI with P&P] Send a 486 (Busy Here) response code and a Reason header where the Reason-params has the value `preemption;cause=1;text="UA Preemption"` over the IP network toward the remote SC serving the IP EI that initiated the call request being preempted or the remote AS-SIP EI that initiated the call request being preempted.

In the case of a remote proprietary IP EI the remote SC will interrupt the user signaling (i.e., ringback) at the remote proprietary IP EI that has the call request being preempted, activate a preemption tone for 3 seconds, terminate the session at the remote IP EI, and respond with an ACK to the local AS-SIP EI that initiated the preemption.

In the case of a remote AS-SIP EI with P&P the remote AS-SIP EI with P&P will interrupt the user signaling (i.e., ringback), activate a preemption tone for 3 seconds, terminate the session, and respond with an ACK to the local AS-SIP EI that initiated the preemption.

In the case of a remote RO AS-SIP EI the remote RO AS-SIP EI will interrupt the user signaling (i.e., ringback), terminate the session, and respond with an ACK to the local AS-SIP EI that initiated the preemption.

SIP-005270.d [Required: AS-SIP EI with P&P] The local AS-SIP EI will receive an ACK response to the 486 (Busy Here) response code.

SIP-005270.e [Required: AS-SIP EI with P&P] The local AS-SIP EI will continue the call setup for the higher precedence call by activating user signaling (i.e., playing precedence ringing tone).

⁴² By definition a RO AS-SIP EI does not initiate precedence calls.

6.4.2.3.3 Endpoint Preemption of an Outbound Call Request

6.4.2.3.3.1 Endpoint Preemption of an Outbound Call Request Conducted by an SC on Behalf of a Served IP EI (Other Than an AS-SIP EI)

SIP-005280 Whenever an SC performs an endpoint preemption of an outbound call request on behalf of an IP EI that has not received a 2xx response, then the SC MUST:

SIP-005280.a Interrupt current user signaling associated with the outbound call request (e.g., ringback) and activate user signaling (i.e., preemption tone) at the local IP EI where the existing call is being preempted.

SIP-005280.b Send a 180 (Ringing) response to the remote SC or remote AS-SIP EI with P&P that initiated the higher precedence call request.⁴³ The remote SC or remote AS-SIP EI with P&P will activate user signaling (i.e., precedence ringback tone) for the caller.

SIP-005280.c If an early dialog has been established, send a BYE or CANCEL request with a Reason header where the Reason-params has the value preemption ;cause=1 ;text="UA Preemption" to the SC serving the remote called IP EI or to the remote AS-SIP EI at the other end of the preempted call request.

In the case of a remote proprietary IP EI the remote SC will deactivate the ringing tone, terminate the call request, and respond with a 200 (OK) response to a BYE request or a 200 (OK) response to a CANCEL request followed by a 487 (Request Terminated) response to the INVITE sent by the originating SC.

In the case of a remote AS-SIP EI with P&P the remote AS-SIP EI with P&P deactivates the ringing tone, terminates the call request, and responds with a 200 (OK) response to a BYE request or a 200 (OK) response to a CANCEL request followed by a 487 (Request Terminated) response to the INVITE sent by the originating SC.

In the case of a remote RO AS-SIP EI the remote RO AS-SIP EI deactivates the ringing tone, terminates the call request, and responds with a 200 (OK) response to a BYE request or a 200 (OK) response to a CANCEL request followed by a 487 (Request Terminated) response to the INVITE sent by the originating SC.

NOTE: There is no particular purpose to playing the preemption tone for 3 seconds at the remote EI before terminating the call unless the remote SC has received a 200 (OK) (or equivalent) response from its local IP EI indicating the telephone is off-hook or in the case of a remote AS-SIP EI with P&P, unless the remote AS-SIP EI with P&P has detected an off-hook or equivalent.

SIP-005280.d If an early dialog has NOT been established, the local SC sends a CANCEL request with a Reason header where the Reason-params has the value

⁴³ By definition a RO AS-SIP EI does not initiate precedence calls.

preemption ;cause=1 ;text="UA Preemption" to the remote SC of the called IP EI in the preempted call request or to the remote AS-SIP EI in the preempted call request.

NOTE: If the local SC has not received any provisional response, it MUST wait to receive a provisional response before sending the CANCEL. In the event the first response is a final response, then the SC sends a BYE request instead of a CANCEL.

In the case of a remote proprietary IP EI the remote SC will deactivate the ringing tone, respond with a 200 (OK) response to a BYE request or a 200 (OK) response to a CANCEL followed by a 487 (Request Terminated) response to the INVITE, and terminate the call.

In the case of a remote AS-SIP EI with P&P the remote AS-SIP EI with P&P will deactivate the ringing tone, respond with a 200 (OK) response to a BYE request or a 200 (OK) response to a CANCEL followed by a 487 response to the INVITE, and terminate the call.

In the case of a remote RO AS-SIP EI the remote RO AS-SIP EI will deactivate the ringing tone, respond with a 200 (OK) response to a BYE request or a 200 (OK) response to a CANCEL followed by a 487 response to the INVITE, and terminate the call.

NOTE: There is no particular purpose to playing the preemption tone for 3 seconds at the remote EI before terminating the call unless the remote SC has received a 200 (OK) (or equivalent) response from its local IP EI indicating the telephone is off-hook or in the case of a remote AS-SIP EI with P&P, unless the remote AS-SIP EI with P&P has detected an off-hook or equivalent.

SIP-005280.e The local SC will receive a 200 (OK) response to the BYE or CANCEL request. In the case of a CANCEL request, the SC will generally receive a 487 (Request Terminated) response to the INVITE request. However, since RFC 2543-compliant SIP appliances do not send a 487 response if the local SC were to wait for a 487 response from the far end that is not being sent, the delay until the call could technically be considered to have been cancelled is $64 * T1$ seconds (where T1 is defined in RFC 3261, Section 17.1.1.1, Overview of INVITE Transaction). Hence, we will consider the call terminated upon the receipt of the 200 (OK) response.

SIP-005280.f Upon the receiver going on-hook, the local SC will continue the call setup for the higher precedence call by activating user signaling at the local IP EI (i.e., precedence ringing tone).

6.4.2.3.3.2 Endpoint Preemption of an Outbound Call Request Conducted by an AS-SIP EI

SIP-005290 [Required: AS-SIP EI with P&P] Whenever an AS-SIP EI performs an endpoint preemption of an outbound call request for which it has not received a 2xx response, then the AS-SIP EI MUST:

SIP-005290.a [Required: AS-SIP EI with P&P] Interrupt current user signaling associated with the outbound call request (e.g., stop playing ringback) and activate user signaling (i.e., play preemption tone) to the user.

SIP-005290.b [Required: AS-SIP EI with P&P] Send a 180 (Ringing) response to the remote SC or remote AS-SIP EI with P&P that initiated the higher precedence call request.⁴⁴ The remote SC or remote AS-SIP EI with P&P will activate user signaling (i.e., precedence ringback tone) for the caller.

SIP-005290.c If an early dialog has been established, send a BYE or CANCEL request with a Reason header where the Reason-params has the value preemption ;cause=1 ;text="UA Preemption" to the SC serving the remote called IP EI or the remote AS-SIP EI at the other end of the preempted call request.

In the case of a remote proprietary IP EI the remote SC will deactivate the ringing tone, terminate the call request, and respond with a 200 (OK) response to a BYE request or a 200 (OK) response to a CANCEL request followed by a 487 (Request Terminated) response to the INVITE sent by the originating SC.

In the case of a remote AS-SIP EI with P&P the remote AS-SIP EI with P&P deactivates the ringing tone, terminates the call request, and responds with a 200 (OK) response to a BYE request or a 200 (OK) response to a CANCEL request followed by a 487 response to the INVITE sent by the originating SC.

In the case of a remote RO AS-SIP EI the remote RO AS-SIP EI deactivates the ringing tone, terminates the call request, and responds with a 200 (OK) response to a BYE request or a 200 (OK) response to a CANCEL request followed by a 487 response to the INVITE sent by the originating SC.

NOTE: There is no particular purpose to playing the preemption tone for 3 seconds at the remote EI before terminating the call unless the remote SC has received a 200 (OK) (or equivalent) response from its local IP EI indicating the telephone is off-hook, or in the case of a remote AS-SIP EI with P&P, unless the remote AS-SIP EI with P&P has detected an off-hook or equivalent.

SIP-005290.d [Required: AS-SIP EI with P&P] If an early dialog has NOT been established, the AS-SIP EI sends a CANCEL request with a Reason header where the Reason-params has the value preemption ;cause=1 ;text="UA Preemption" to the remote SC of the called IP EI in the preempted call request or to the remote AS-SIP EI in the preempted call request.

NOTE: If the AS-SIP EI has not received any provisional response, it MUST wait to receive a provisional response before sending the CANCEL request. In the event the first

⁴⁴ By definition a RO AS-SIP EI does not initiate precedence calls.

response is a final response, then the AS-SIP EI sends a BYE request instead of a CANCEL request.

In the case of a remote proprietary IP EI the remote SC will deactivate the ringing tone, respond with a 200 (OK) response to a BYE request or a 200 (OK) response to a CANCEL request followed by a 487 (Request Terminated) response to the INVITE, and terminate the call.

In the case of a remote AS-SIP EI with P&P the remote AS-SIP EI with P&P will deactivate the ringing tone, respond with a 200 (OK) response to a BYE request or a 200 (OK) response to a CANCEL request followed by a 487 response to the INVITE, and terminate the call.

In the case of a remote RO AS-SIP EI the remote RO AS-SIP EI will deactivate the ringing tone, respond with a 200 (OK) response to a BYE request or a 200 (OK) response to a CANCEL request followed by a 487 response to the INVITE, and terminate the call.

NOTE: There is no particular purpose to playing the preemption tone for 3 seconds at the remote EI before terminating the call unless the remote SC has received a 200 (OK) (or equivalent) response from its local IP EI indicating the telephone is off-hook, or in the case of a remote AS-SIP EI with P&P, unless the remote AS-SIP EI with P&P has detected an off-hook or equivalent.

SIP-005290.e [Required: AS-SIP EI with P&P] The local AS-SIP EI will receive a 200 (OK) response to the BYE or CANCEL request. In the case of a CANCEL request, the AS-SIP EI will generally receive a 487 (Request Terminated) response to the INVITE request. However, since RFC 2543-compliant SIP appliances do not send a 487 response if the local AS-SIP EI was to wait for a 487 response from the far end that is not being sent, the delay until the call could technically be considered to have been cancelled is 64*T1 seconds (where T1 is defined in RFC 3261, Section 17.1.1.1, Overview of INVITE Transaction). Hence, we will consider the call terminated upon receipt of the 200 (OK) response.

SIP-005290.f [Required: AS-SIP EI with P&P] Upon the receiver going on-hook, the local AS-SIP EI will continue the call setup for the higher precedence call by activating user signaling at the local IP EI (i.e., precedence ringing tone).

6.4.2.3.4 Remote SC Response to Notification of IP Endpoint Preemption

NOTE: When an SC serves an AS-SIP EI, then AS-SIP messages conveying the Reason header for Preemption, intended for the served AS-SIP EI, are forwarded by the SC to the AS-SIP EI.

SIP-005300 Whenever an SC receives an inbound BYE request with a Reason header where the Reason-params has the value preemption ;cause=1;text="UA Preemption" intended to preempt an existing call, then:

SIP-005300.a If the served IP EI is an AS-SIP EI, the SC forwards the BYE request to the AS-SIP EI.

In the case of an AS-SIP EI with P&P the AS-SIP EI with P&P activates the user signaling requirements (e.g., plays a preemption tone for a minimum of 3 seconds), responds back with a 200 (OK) response, and terminates the session.

In the case of a RO AS-SIP EI the RO AS-SIP EI responds back with a 200 (OK) response and terminates the session.

The serving SC forwards the 200 (OK) response over the IP network.

SIP-005300.b If the served IP EI is NOT an AS-SIP EI, the SC activates the user signaling requirements (e.g., sends a preemption tone for a minimum of 3 seconds), sends a termination signaling message to the IP EI to terminate the session, and responds over the network with a 200 (OK) response.

SIP-005310 Whenever an SC receives an inbound 486 (Busy Here) response code with a Reason header where the Reason-params has the value preemption ;cause=1 ;text="UA Preemption" for an outbound call request (i.e., the SC is serving an IP EI that initiated a call request (which has not completed) and the far end is conducting endpoint preemption), then:

SIP-005310.a If the served IP EI is an AS-SIP EI, the SC forwards the 486 (Busy Here) response to the AS-SIP EI.

In the case of an AS-SIP EI with P&P the AS-SIP EI with P&P deactivates the user signaling (i.e., ringback), activates a preemption tone for 3 seconds, sends an ACK response, and terminates the session.

In the case of a RO AS-SIP EI the RO AS-SIP EI sends an ACK response and terminates the session.

SIP-005310.b If the served IP EI is NOT an AS-SIP EI, the SC deactivates the user signaling (i.e., ringback), activates a preemption tone for 3 seconds, then conducts call termination with the IP EI, and sends an ACK response.

SIP-005320 Whenever an SC receives an inbound BYE request (or an inbound CANCEL request) with a Reason Header where the Reason params has the value preemption ;cause=1 ;text="UA Preemption" for an inbound call request in the process of session establishment (receiver is still on-hook), then:

SIP-005320.a If the served IP EI is an AS-SIP EI, the SC sends the BYE request (or CANCEL request) to the AS-SIP EI.

In the case of an AS-SIP EI with P&P the AS-SIP EI with P&P deactivates the ringing tone, returns a 200 (OK) response, which the SC forwards over the network, and terminates the call. In the case of a CANCEL request, the AS-SIP EI with P&P will

return a 487 (Request Terminated) request to the INVITE request, which the SC will forward over the network.

In the case of a RO AS-SIP EI the RO AS-SIP EI deactivates the ringing tone, returns a 200 (OK) response, which the SC forwards over the network, and terminates the call. In the case of a CANCEL request, the RO AS-SIP EI will return a 487 (Request Terminated) request to the INVITE request, which the SC will forward over the network.

SIP-005320.b If the served IP EI is NOT an AS-SIP EI, the SC sends a termination signaling message to the IP EI to terminate the session and deactivate the ringing tone. The SC responds back over the network with a 200 (OK) response. In the case of a CANCEL request, the SC sends a 487 (Request Terminated) response over the network for the INVITE request.

6.4.3 Network Preemption

6.4.3.1 Circumstances Under Which an SC Performs Network Preemption

SIP-005330 When an SC receives an outbound precedence call request from a served IP EI and there are insufficient resources to support the outbound precedence call request (e.g., call count threshold has been reached for the link), the SC MUST compare the precedence level of the new precedence call request with the precedence levels of the existing calls and/or call requests to determine whether there are sufficient resources of lesser precedence that can be preempted to accommodate the new precedence call request. This comparison can only occur for calls and call requests having the same value for the precedence-domain subfield in the namespace of the Resource-Priority header field.

SIP-005330.a If there are no preemptable resources to accommodate the new precedence call request, the SC MUST reject the precedence call request. The SC is responsible for overseeing the playing of the BPA at the local IP EI followed by the termination of the call request. The BPA will indicate that the local SC blocked the precedence call.

NOTE: In the case of a served AS-SIP EI with P&P, when the SC serving the calling AS-SIP EI with P&P determines there are insufficient network resources to support the outbound precedence call request and there are no lesser priority calls available for preemption, then the SC establishes a bearer connection between the AS-SIP EI and a media server associated with the SC.⁴⁵ Please see [Figure 6.4-3](#), SC Implementation of BPA for AS-SIP EI Due to Lack of Network Resources at SC Access Link. The SC and media server exchange the necessary signaling to provide the media server with the IP address and UDP port for the bearer stream with the AS-SIP EI, and the SC instructs the media server to play the BPA over the bearer stream to the AS-SIP EI after the bearer is established. The 183 (Session Progress)

⁴⁵ The scope of this note is limited to the AS-SIP EI with P&P because by definition a RO AS-SIP EI does not initiate precedence calls.

response sent by the SC to the AS-SIP EI includes the sdp answer with the IP address and UDP port for a bearer stream with the media server. The AS-SIP EI responds with a PRACK to which the SC responds with a 200 (OK) response. The media server plays the announcement to the AS-SIP EI and terminates the session with the SC, and the SC sends a 488 (Not Acceptable Here) response that includes a Warning header field with warning code 370 (Insufficient Bandwidth) to the AS-SIP EI. The AS-SIP EI responds with an ACK and terminates the call request.

NOTE: The media server is considered a part of the SC SUT; therefore, the signaling between the SC and media server is left to the vendor as long as the announcement is played and the signaling between the SC and AS-SIP EI complies with the specific call flow depicted in this section.

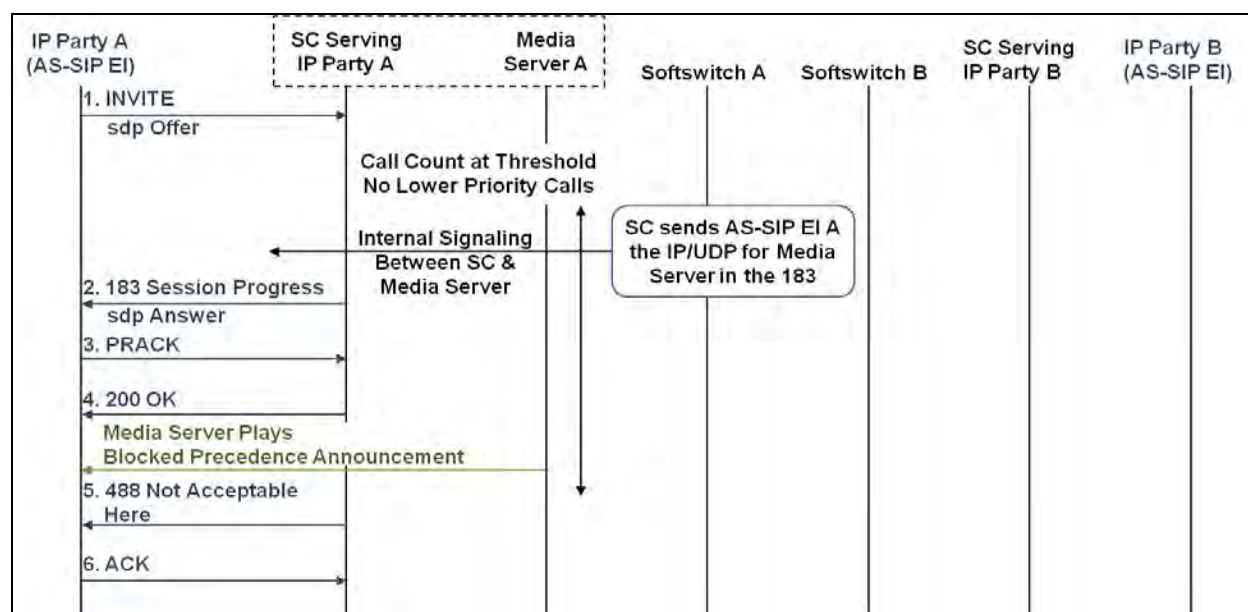

Figure 6.4-3. SC Implementation of BPA for AS-SIP EI with P&P Because of Lack of Network Resources at SC Access Link

SIP-005330.b If there are sufficient resources that are preemptable, the SC MUST preempt existing call requests and calls using the following scheme:

- Identify the lowest priority call requests and calls having the same value for the precedence-domain subfield. If there is directionalization, then the set of preemptable call requests and calls consists only of those calls and call requests initiated in the same direction as the new precedence call request (i.e., a new outbound precedence call request is compared against other outbound call requests and calls; a new inbound precedence call request is compared against other inbound call requests and calls).
- Preempt call requests before preempting existing calls.

- If there are insufficient call requests and calls at the lowest priority to meet the preemption needs, then go to the next lowest priority level and preempt call requests before preempting existing calls (all of which MUST have the same value for the precedence-domain subfield).
- Repeat this process until the necessary resources have been freed up for the precedence call request.

NOTE: The SC has determined at the start that there were sufficient lesser precedence call requests and calls to satisfy the resource requirements of the precedence call request.)

The mechanism for selecting between call requests of a given priority level or between existing calls of a given priority level is left to the vendor with the caveat that the ordering scheme must be deterministic and must always be applied consistently. For example, if there are multiple call requests at the ROUTINE priority level, the SC may preempt call requests based on the most recent call request being preempted first or the oldest call request being preempted first. Whatever methodology is selected it is required that it be deterministic and that it be applied the same way every time. The SC MUST perform the network preemption per, [Section 6.4.3.2](#), Implementing the Network Preemption, and then send the AS-SIP INVITE for the new precedence call request into the WAN (Network Preemption).

SIP-005340 When an SC receives an inbound precedence call request from a remote AS-SIP signaling appliance that is intended for a served IP EI and there are insufficient resources to support the inbound precedence call request (e.g., call count threshold has been reached for the link), the SC MUST compare the precedence level of the new precedence call request with the precedence levels of the existing calls and/or call requests to determine whether there are sufficient resources of lesser precedence that can be preempted to accommodate the new precedence call request. This comparison can only occur for calls and call requests having the same value for the precedence-domain subfield in the namespace of the Resource-Priority header field.

SIP-005340.a If there are no preemptable resources to accommodate the new precedence call request, the SC MUST reject the precedence call request by sending a 488 (Not Acceptable Here) response code that MUST include a Warning header field with warning code 370 (Insufficient Bandwidth) to the remote SC.

NOTE: The remote SC serving the calling IP EI will ensure that a BPA is played to its local IP EI, and then terminate the call request. The BPA will notify the user that the call was blocked by a remote AS-SIP signaling appliance. The individual switch name and location of the preempting switch will not be conveyed to the user.

SIP-005340.b If there are sufficient resources that are preemptable, the SC MUST preempt existing call requests and calls as described in SIP-005530.b (preempt lowest priority call requests before lowest priority existing calls, etc.). The SC MUST perform

the network preemption per, [Section 6.4.3.2](#), Implementing the Network Preemption. Then the SC will forward the new precedence call request to its local IP EI (Network Preemption).

6.4.3.2 Implementing the Network Preemption

SIP-005350 Whenever an SC preempts an existing call of a served IP EI, the SC MUST NOT consider the existing call to be terminated until the SC has received an acknowledgement from its local IP EI that the call has been terminated (e.g., in the case of an AS-SIP EI or SIP EI this means receiving a 200 (OK) response to a BYE request) and until the SC has received a 200 (OK) response to the BYE request sent to the remote SC serving the remote IP EI whose call is being preempted or to the remote AS-SIP EI whose call is being preempted.

SIP-005360 Whenever an SC preempts an inbound call request of a served IP EI, the SC MUST NOT consider the existing call request to be terminated until the SC has received an acknowledgement from its local IP EI that the call has been terminated (e.g., in the case of an AS-SIP EI or SIP EI receiving a 200 (OK) response to a BYE request or a 200 (OK) response to a CANCEL request possibly followed by a 487 (Request Terminated) response to the INVITE) and until the SC has received an ACK to the 488 (Not Acceptable Here) response code sent to the remote SC serving the remote IP EI whose call is being preempted or the remote AS-SIP EI whose call is being preempted.

NOTE: In the case in which the SC sends a CANCEL request to its local SIP EI, if the local SIP EI is RFC 2543 compliant but not RFC 3261 compliant, it will not send a 487 (Request Terminated) response and the local SC will consider the call leg with the local SIP EI terminated upon receipt of the 200 (OK) response to the CANCEL request.

SIP-005370 Whenever an SC preempts an outbound call request of a served IP EI, the SC MUST NOT consider the existing call request to be terminated until the SC has received an acknowledgement from its local IP EI that the call has been terminated (e.g., in the case of an AS-SIP EI or a SIP EI receiving an ACK to the 488 (Not Acceptable Here) response code) and has received a 200 (OK) response to the BYE request, or a 200 (OK) response to a CANCEL request from the remote SC serving the remote IP EI that has the call being preempted or the remote AS-SIP EI that has the call being preempted.

NOTE: Since RFC 2543-compliant SIP appliances do not send a 487 (Request Terminated) response, if the SC was to wait for a 487 response from the far end that is not being sent, the delay until the call could technically be considered to have been cancelled is $64 * T1$ seconds (where $T1$ is defined in RFC 3261, Section 17.1.1.1, Overview of INVITE Transaction). Hence, we will consider the call terminated upon receipt of the 200 (OK) response.

6.4.3.2.1 Network Preemption of Active Call

SIP-005380 Whenever an SC performs a network preemption of an active call, then the SC MUST:

SIP-005380.a In the case of an IP EI other than an AS-SIP EI, activate the preemption tone at the local IP EI for a minimum of 3 seconds, and then send a termination message to the local IP EI.

SIP-005380.b In the case of an AS-SIP EI, send a SIP BYE request with a Reason header where the Reason-params has the value preemption ;cause=5 ;text="Network Preemption" to the local AS-SIP EI.

In the case of an AS-SIP EI with P&P the AS-SIP EI with P&P activates the preemption tone for a minimum of 3 seconds, sends a 200 (OK) response, and terminates the session.

In the case of a RO AS-SIP EI the RO AS-SIP EI sends a 200 (OK) response and terminates the session.

SIP-005380.c Send a BYE request with a Reason header where the Reason-params has the value preemption;cause=5 ;text="Network Preemption" over the IP network to the remote SC serving the remote IP EI or the remote AS-SIP EI in the preempted call.

In the case of a remote proprietary IP EI the remote SC will activate the preemption tone at its remote IP EI for a minimum of 3 seconds, and then send a termination message to its IP EI.

In the case of a remote AS-SIP EI with P&P the remote AS-SIP EI with P&P will receive the BYE request, play the preemption tone for 3 seconds, respond with a 200 (OK) response, and terminate the session.

In the case of a remote RO AS-SIP EI the remote RO AS-SIP EI will receive the BYE request, respond with a 200 (OK) and terminate the session.

SIP-005380.d The SC that initiated the network preemption will receive a 200 (OK) response code from the remote SC or remote AS-SIP EI.

6.4.3.2.2 Network Preemption of an Inbound Call Request

SIP-005390 Whenever an SC performs a network preemption of an inbound call request (receiver is on-hook), then the SC MUST:

SIP-005390.a In the case of an IP EI other than an AS-SIP EI, conduct call termination with the local IP EI that deactivates the ringing tone.

SIP-005390.b In the case of an AS-SIP EI, the SC sends a SIP BYE request or CANCEL request, as appropriate, with a Reason header where the Reason-params has the value `preemption ;cause=5 ;text="Network Preemption"` to the AS-SIP EI.

In the case of an AS-SIP EI with P&P the AS-SIP EI with P&P deactivates the ringing tone, sends a 200 (OK) response, and terminates the inbound call request.

In the case of a RO AS-SIP EI the RO AS-SIP EI deactivates the ringing tone, sends a 200 (OK) response and terminates the inbound call request.

SIP-005390.c Send a 488 (Not Acceptable Here) response code that MUST include a Warning header field with Warning code 370 (Insufficient Bandwidth) with a Reason header where the Reason-params has the value `preemption;cause=5 ;text="Network Preemption"` over the IP network to the originating SC serving the originating IP EI in the preempted call or to the originating AS-SIP EI in the preempted call.

In the case of a proprietary IP EI the originating SC deactivates the ringback tone on the originating IP EI, sends a preemption tone for a minimum of 3 seconds, conducts call termination with the originating IP EI, and responds with an ACK.

In the case of an AS-SIP EI with P&P the originating AS-SIP EI with P&P receives the 488 (Not Acceptable Here) response code, plays a preemption tone for a minimum of 3 seconds, responds with an ACK, and terminates the call request.

In the case of a RO AS-SIP EI the originating RO AS-SIP EI receives the 488 (Not Acceptable Here) response code, responds with an ACK and terminates the call request.

SIP-005390.d The SC that initiated the network preemption will receive an ACK response to the 488 (Not Acceptable Here) response code.

6.4.3.2.3 *Network Preemption of an Outbound Call Request*

SIP-005400 Whenever an SC performs a network preemption of an outbound call request from a locally served IP EI that has not received a 2xx response, then the SC MUST:

SIP-005400.a In the case of an IP EI other than an AS-SIP EI, deactivate any user signaling (e.g., ringback), activate the preemption tone for a minimum of 3 seconds, and then conduct call termination.

SIP-005400.b In the case of an AS-SIP EI, the SC sends a 488 (Not Acceptable Here) response code that MUST include a Warning header field with Warning code 370 (Insufficient Bandwidth) with a Reason header where the Reason-params has the value `preemption;cause=5 ;text="Network Preemption"` to the AS-SIP EI.

When the AS-SIP EI is an AS-SIP EI with P&P then the AS-SIP EI with P&P deactivates any user signaling (e.g., ringback), activates the preemption tone for a minimum of 3 seconds, responds to the SC with an ACK, and terminates the call request.

When the AS-SIP EI is a RO AS-SIP EI then the RO AS-SIP EI deactivates any user signaling (e.g., ringback), responds to the SC with an ACK and terminates the call request.

SIP-005400.c If an early dialog has been established, send a BYE or CANCEL request with a Reason header where the Reason-params has the value `preemption;cause=5;text="Network Preemption"` to the remote SC serving the called IP EI in the preempted call request or the remote AS-SIP EI in the preempted call request. The remote SC will conduct call termination with its IP EI that deactivates the user signaling (i.e., ringing tone), and will respond with a 200 (OK) response, or in the case of a remote AS-SIP EI, the remote AS-SIP EI will deactivate the ringing tone and respond with a 200 (OK) response.

NOTE: There is no particular purpose to playing the preemption tone for 3 seconds at the remote SC or remote AS-SIP EI with P&P before terminating the call unless the remote SC has received an indication that the EI is off-hook or in the case of an AS-SIP EI with P&P, unless the user has gone off-hook.

SIP-005400.d If an early dialog has not been established, send a CANCEL request with a Reason header where the Reason-params has the value `preemption;cause=5;text="Network Preemption"` to the remote SC serving the called IP EI in the preempted call request or the remote AS-SIP EI in the preempted call request.

NOTE: If the SC has not received any provisional response, it MUST wait to receive a provisional response before sending the CANCEL. In the event the first response is a final response, then the SC sends a BYE request instead of a CANCEL request.

In the case of a proprietary IP EI the remote SC will conduct call termination with its IP EI, which deactivates the user signaling (i.e., ringing tone) and will respond with a 200 (OK) response. In the case of a remote AS-SIP EI, the remote AS-SIP EI will deactivate the ringing tone and respond with a 200 (OK) response.

NOTE: There is no particular purpose to playing the preemption tone for 3 seconds before terminating the call unless the SC has received an indication that the EI is off-hook or in the case of an AS-SIP EI with P&P, unless the user has gone off-hook.

SIP-005400.e The SC that initiated the network preemption will receive a 200 (OK) response code to the BYE or CANCEL request from the remote SC or remote AS-SIP EI.

6.5 ASAC RULE SET

NOTE: This section comprises the rules governing when to increment and decrement voice and video call counts and assumes the necessary network resources are available.

[Section 6.4.3](#), Network Preemption, provides the rules for what an SC must do when incrementing a call count that would exceed a configured threshold.

[Section 7](#), SS Policing of Call Count Thresholds, provides the rules by which an SS polices ASAC call counts.

6.5.1 SC Component of SS

SIP-005410 SC component of an SS MUST perform ASAC call counting IAW the ASAC rules defined in [Section 6.5](#), ASAC Rule Set.

6.5.2 Empty INVITE

SIP-005420 Unless covered by the exception set forth in Requirement SIP-005420, when an SC either receives a SIP INVITE request from a served SIP EI that does not include an sdp body (Empty INVITE) or generates a SIP INVITE request on behalf of a non-SIP IP EI that does not have an sdp body, then the SC MUST classify the call request for ASAC purposes as a telephony call and increment the telephony ASAC call count (or outbound telephony call count in the case of directionalization) by one.

SIP-005420.a An SC that receives a SIP INVITE request from a served SIP EI that does not include an sdp body but does include a Contact header with the media feature tag “video,” or generates a SIP INVITE request on behalf of a non-SIP IP EI that does not have an sdp body but does include a Contact header with the media feature tag “video,” MAY increment the video ASAC call count (or outbound video call count) by at least one VSU instead of incrementing the telephony call count (or outbound telephony call count).

NOTE: Depending on the outcome of the offer-answer exchange the SC may need to modify the number of VSUs (or outbound VSUs) allocated for the call.

SIP-005430 receipt of an inbound Empty INVITE intended for a directly served IP EI, an SC MUST classify the call request for ASAC purposes as a telephony call and increment the telephony ASAC call count (or inbound telephony call count in the case of directionalization) by one UNLESS:

SIP-005430.a The Contact header includes the media feature tag “video” and the SC is capable of processing the media feature tag, in which case the SC MAY increment the video ASAC call count (or inbound video call count in the case of directionalization) by one or more VSUs. If the EI responds by offering video capabilities greater than the number of VSUs just allocated for the call request, then the SC MUST increment the video call count (or inbound video call count in the case of directionalization) by the additional VSUs necessary to cover the video offer.

NOTE: If the SC initially increments the video ASAC call count by “n” VSUs, but the called EI responds with an offer for a telephony call, then the SC MUST immediately decrement the video ASAC call count (or inbound video call count in the case of directionalization) by “n” VSUs, and then increment the telephony call count (or inbound telephony call count in the case of directionalization) by one.

NOTE: If the SC initially classifies the call request as a telephony call (or an inbound telephony call in the case of directionalization), but the EI offers audio and video capabilities, then the SC will decrement the telephony call count (or inbound telephony call count) and increment the video call count (or inbound video call count in the case of directionalization) by the appropriate number of VSUs and send a response that includes an sdp offer of audio and video capabilities.

6.5.3 SC

6.5.3.1 *Outbound INVITE and re-INVITE*

6.5.3.1.1 *Outbound INVITE*

SIP-005440 When the SC receives a SIP INVITE request from a served AS-SIP EI or SIP EI, or receives an outbound call request from a served non-SIP IP EI that is intended for a destination outside the enclave and the INVITE that is forwarded or generated includes an sdp offer specifying audio capabilities, then the SC increments the telephony call count (or outbound telephony call count in the case of directionalization) by one and sends the INVITE to its SS.

SIP-005440.a When the SC receives a SIP INVITE request from a served AS-SIP EI or SIP EI, or receives an outbound call request from a served non-SIP IP EI that is intended for a destination outside the enclave and the INVITE that is forwarded or generated includes an sdp offer specifying audio and video capabilities, then the SC increments the video call count (or outbound video call count in the case of directionalization) by the appropriate number of VSUs and sends the INVITE to its SS.

6.5.3.1.2 *Outbound re-INVITE on Existing Telephony Call*

SIP-005450 When the SC receives a SIP re-INVITE from a served AS-SIP EI or SIP EI, or receives an outbound call request from a served non-SIP IP EI (that will cause the SC to generate a re-INVITE) AND the re-INVITE is intended for a destination outside the enclave AND the re-INVITE offers audio and video capabilities AND the existing call is budgeted against the telephony call count, THEN the SC MUST increment the video call count (or outbound video call count) by the appropriate number of VSUs.

SIP-005450.a If the response to the re-INVITE is either a failure response (e.g., 4xx) or a 2xx response that rejects the video offer, then upon receipt of the response the SC

decrements the video call count (or outbound video call count) by the number of VSUs that had been previously incremented.

SIP-005450.b If the response is a 2xx that accepts the video capabilities, then the SC decrements the telephony call count by one upon receipt of the 200 (OK) response.

NOTE: If the SC uses directionalization, then the SC MUST decrement the outbound telephony call count or inbound telephony call count depending on the classification of the original call.

SIP-005460 When the SC receives a SIP re-INVITE from a served AS-SIP EI or SIP EI, or receives an outbound call request from a served non-SIP IP EI (that will cause the SC to generate a re-INVITE) that is intended for a destination outside the enclave AND the re-INVITE offers audio capabilities only AND the existing call is budgeted against the telephony call count (or the outbound telephony call count or inbound telephony call count in the case of directionalization), THEN the SC makes no change to the telephony call count (or outbound telephony call count or inbound telephony call count).

6.5.3.1.3 Outbound re-INVITE on Existing Video Call

SIP-005470 When the SC receives a SIP re-INVITE from a served AS-SIP EI or SIP EI, or receives an outbound call request from a served non-SIP IP EI (that will cause the SC to generate a re-INVITE) and the re-INVITE is intended for a destination outside the enclave AND the re-INVITE offers audio capabilities only AND the existing call is budgeted against the video call count, THEN the SC MUST increment the telephony call count (or outbound telephony call count) by one.

SIP-005470.a If the response to the re-INVITE is either a failure response (e.g., 4xx) or a 2xx response that rejects the telephony offer, then upon receipt of the response, the SC decrements the telephony call count (or outbound telephony call count) by one.

SIP-005470.b If the response is a 2xx that accepts the audio capabilities, then the SC decrements the video call count by the appropriate number of VSUs upon receipt of the 200 response.

NOTE: If the SC uses directionalization, then the SC MUST decrement the outbound video call count or inbound video call count depending on the classification of the original call.

SIP-005480 When the SC receives a SIP re-INVITE from a served AS-SIP EI or SIP EI, or receives an outbound call request from a served non-SIP IP EI (that will cause the SC to generate a re-INVITE) that is intended for a destination outside the enclave AND the re-INVITE offers audio and video capabilities AND the existing call is budgeted against the video call count (or the outbound video call count or inbound video call count in the case of directionalization) then:

SIP-005480.a If the proposed video call count is greater than the current video call count, the SC MUST increment the video call count (or if the SC uses directionalization, then the SC increments the outbound video call count or inbound video call count depending on the classification of the original call) by the difference in VSUs between the proposed video call count and the current video call count.

SIP-005480.a.1 If the response to the re-INVITE is either a failure response (e.g., 4xx) or a 2xx response that rejects the video offer, then upon receipt of the response, the SC decrements the video call count by the amount of VSUs it had previously added to support the re-INVITE.

NOTE: If an existing video session requests the budget allocation to be increased (i.e., requesting a higher bandwidth video session) and the request is rejected either by the originating or terminating SC, or the terminating video EI, then the session should not be terminated, but remain at its original session budgets.

SIP-005480.b If the proposed video call count is less than the current video call count, the SC does not alter the video call count until receipt of the response to the offer.

SIP-005480.b.1 If the response to the re-INVITE is either a failure response (e.g., 4xx) or a 2xx response that rejects the video offer, then upon receipt of the response the SC makes no change to the video call count.

SIP-005480.b.2 If the response to the re-INVITE is a 200 response accepting the offer, then the SC reduces the video call count (or if the SC uses directionalization, then the SC decrements the outbound video call count or inbound video call count depending on the classification of the original call) by the difference in VSUs between the proposed video call count and the current video call count.

6.5.3.1.4 Outbound BYE

SIP-005490 When an SC sends a BYE request to its SS intended for an IP EI outside the enclave, the SC refrains from decrementing the call count associated with the given call until the SC receives the 200 (OK) response to the BYE from the far end.

6.5.3.2 Inbound INVITE and re-INVITE

6.5.3.2.1 Inbound INVITE

SIP-005500 When an SC receives an inbound INVITE intended for a served IP EI that includes an sdp body offering only audio capabilities, the SC MUST classify the call request for ASAC purposes as a telephony call and increment the telephony call count (or inbound telephony call count in the case of directionalization) by one.

SIP-005510 When an SC receives an inbound INVITE intended for a served IP EI that includes an sdp body offering audio and video capabilities, the SC MUST classify the call request for ASAC purposes as a video call and increment the video call count (or inbound video count in the case of directionalization) by the appropriate number of VSUs.

NOTE: If the EI accepts only the audio offer, and therefore, the initial response to the INVITE (be it a reliable provisional 18x response or a final 200 (OK) response) includes an sdp answer accepting only the audio offer, then the SC MUST decrement the video call count (or inbound video call count in the case of directionalization) by the number of VSUs previously incremented and increment the telephony call count (or inbound telephony call count in the case of directionalization) by one.

6.5.3.2.2 *Inbound re-INVITE on Existing Telephony Call*

SIP-005520 When the SC receives a re-INVITE from outside the enclave, offering audio and video capabilities and intended for a served IP EI, AND the existing call is budgeted against the telephony call count, then the SC MUST increment the video call count (or inbound video call count) by the appropriate number of VSUs and forward the video call request to the EI. If the user responds by accepting the video request, then the SC decrements the telephony call count (or in the case of directionalization decrements the outbound telephony call count or inbound telephony call count depending on the classification of the original call) by one. The SC sends (or forwards) a 200 response with an sdp answer accepting the audio and video capabilities.

SIP-005520.a If the user does not accept the sdp offer or, in particular, the video capabilities in the sdp offer (e.g., end user did not accept video), then the SC decrements the video call count (or inbound video call count) by the number of VSUs that had just previously been incremented. The SC sends (or forwards) a 200 response with an sdp answer rejecting the audio and video capabilities.

SIP-005530 When the SC receives a re-INVITE from outside the enclave, offering audio capabilities only and intended for a served IP EI AND the existing call is budgeted against the telephony call count, then the SC makes no change to the ASAC call counts.

6.5.3.2.3 *Inbound re-INVITE on Existing Video Call*

SIP-005540 When the SC receives a re-INVITE from outside the enclave, offering audio capabilities only and intended for a served IP EI, AND the existing call is budgeted against the video call count, then the SC MUST increment the telephony call count (or inbound telephony call count in the case of directionalization) by one, and forward the telephony call request to the EI. If the user responds by accepting the telephony call request, then the SC decrements the video call count (or in the case of directionalization decrements the outbound video call count or inbound video call count depending on the classification of the original call) by the appropriate

number of VSUs. The SC sends (or forwards) a 200 response with an sdp answer accepting the audio capabilities.

SIP-005540.a If the user does not accept the sdp offer of audio capabilities only, then the SC decrements the telephony call count (or inbound telephony call count) by one. The SC sends (or forwards) a 200 response with an sdp answer rejecting the new audio capabilities.

SIP-005550 When the SC receives a re-INVITE from outside the enclave, offering audio and video capabilities and intended for a served IP EI, AND the existing call is budgeted against the video call count (or the outbound video call count or inbound video call count in the case of directionalization), then:

SIP-005550.a If the proposed video call count is greater than the current video call count, the SC MUST increment the video call count (or if the SC uses directionalization, then the SC increments the outbound video call count or inbound video call count, depending on the classification of the original call), by the difference in VSUs between the proposed video call count and the current video call count, and forwards the video call request to the EI. If the EI accepts the video change, then the SC sends (or forwards) a 200 response with an sdp answer accepting the change in video capabilities.

SIP-005550.a.1 If the EI does not accept the change in video capabilities, then the SC decrements the video call count (or in the case of directionalization, decrements the inbound video call count or outbound video call count depending on the classification of the original call) by the number of VSUs it had just added previously. The SC sends (or forwards) a 200 response with an sdp answer rejecting the new video capabilities.

SIP-005550.b If the proposed video call count is less than the current video call count, the SC forwards the video call request to the EI and if the EI accepts the video change, then the SC reduces the video call count (or if the SC uses directionalization, then the SC decrements the outbound video call count or inbound video call count depending on the classification of the original call) by the difference in VSUs between the proposed video call count and the current video call count and sends (or forwards) a 200 response with an sdp answer accepting the change in video capabilities.

SIP-005550.b.1 If the EI does not accept the change in video capabilities, then the SC makes no change to the ASAC video call count and sends (or forwards) a 200 response with an sdp answer rejecting the new video capabilities.

6.5.3.2.4 Inbound BYE

SIP-005560 When an SC receives a BYE request from outside the enclave intended for a served IP EI, the SC forwards the BYE request or an equivalent termination message to its IP EI,

decrements the call count associated with the given call, and sends the 200 (OK) response to the BYE request back to its SS.

6.5.4 Softswitch

NOTE: [Section 6.5.4.1](#), Outbound INVITE and re-INVITE, and [Section 6.5.4.2](#), Inbound INVITE and re-INVITE, detail the SS ASAC requirements when the INVITE will NOT cause a call count threshold to be exceeded. [Section 7](#), SS Policing of Call Count Thresholds, details the SS policing requirements when, according to the SS, the INVITE will cause a call count threshold to be exceeded.

6.5.4.1 *Outbound INVITE and re-INVITE*

6.5.4.1.1 *Outbound INVITE*

SIP-005570 When the SS receives an INVITE from a served SC that includes an sdp offer specifying audio capabilities, then the SS increments the telephony call count (or outbound telephony call count in the case of directionalization) by one.

SIP-005580 When the SS receives a SIP INVITE request from a served SC that includes an sdp offer specifying audio and video capabilities, then the SS increments the video call count (or outbound video call count in the case of directionalization) by the appropriate number of VSUs.

SIP-005590 When the SS receives a SIP INVITE request from a served SC that does not include an sdp offer (Empty INVITE), then the SS increments the telephony call count (or outbound telephony call count in the case of directionalization) by one.

6.5.4.1.2 *Outbound re-INVITE on Existing Telephony Call*

SIP-005600 When the SS receives a re-INVITE from a served SC AND the re INVITE offers audio and video capabilities AND the existing call is budgeted against the telephony call count, THEN the SS MUST increment the video call count (or outbound video call count) by the appropriate number of VSUs.

SIP-005600.a If the response to the re-INVITE is either a failure response (e.g., 4xx) or a 200 response that rejects the video offer, then upon receiving the failure response or 200 response that does not accept the video portion of the offer, the SS decrements the video call count (or outbound video call count) by the number of VSUs that had been incremented previously.

SIP-005600.b If the response is a 200 response that accepts the video capabilities, then upon receiving the 200 response the SS decrements the telephony call count by one.

NOTE: If directionalization is being used, then the SS MUST decrement the outbound telephony call count or inbound telephony call count depending on the classification of the original call.

SIP-005610 When the SS receives a re-INVITE from a served SC AND the re INVITE offers audio capabilities only AND the existing call is budgeted against the telephony call count (or the outbound telephony call count or inbound telephony call count in the case of directionalization), THEN the SS makes no change to the telephony call count (or outbound telephony call count or inbound telephony call count).

6.5.4.1.3 Outbound re-INVITE on Existing Video Call

SIP-005620 When the SS receives a re-INVITE from a served SC AND the re INVITE offers audio capabilities only AND the existing call is budgeted against the video call count, THEN the SS MUST increment the telephony call count (or outbound telephony call count) by one.

SIP-005620.a 1 If the response to the re-INVITE is either a failure response (e.g., 4xx) or a 200 response that rejects the telephony offer, then upon receiving the failure response or 200 response that rejects the telephony offer the SS decrements the telephony call count (or outbound telephony call count) by one.

SIP-005620.b If the response is a 200 response that accepts the audio capabilities, then upon receiving the 200 answer the SS decrements the video call count by the appropriate number of VSUs.

NOTE: If the SC uses directionalization, then the SS MUST decrement the outbound video call count or inbound video call count depending on the classification of the original call.

SIP-005630 When the SS receives a re-INVITE from a served SC AND the re-INVITE offers audio and video capabilities AND the existing call is budgeted against the video call count (or the outbound video call count or inbound video call count in the case of directionalization), then:

SIP-005630.a If the proposed video call count is greater than the current video call count, the SS MUST increment the video call count (or if the SC uses directionalization, then the SS increments the outbound video call count or inbound video call count depending on the classification of the original call) by the difference in VSUs between the proposed video call count and the current video call count.

SIP-005630.a.1 If the response to the re-INVITE is either a failure response (e.g., 4xx) or a 200 response that rejects the video offer, then upon receiving the failure response or 200 response that rejects the video offer, the SS decrements the video call count by the number of VSUs it had previously added to support the re-INVITE.

SIP-005630.b If the proposed video call count is less than the current video call count, the SS does not alter the video call count until receipt of the response to the offer.

SIP-005630.b.1 If the response to the re-INVITE is either a failure response (e.g., 4xx) or a 200 response that rejects the video offer, then upon receiving the failure response or 200 response that rejects the video offer, the SS makes no change to the video call count.

SIP-005630.b.2 If the response to the re-INVITE is a 200 response accepting the offer, then upon receiving the 200 offer acceptance the SS reduces the video call count (or if the SC uses directionalization, then the SS decrements the outbound video call count or inbound video call count depending on the classification of the original call) by the difference in VSUs between the proposed video call count and the current video call count.

6.5.4.1.4 *Outbound BYE*

SIP-005640 When a SS receives a BYE request from its served SC, the SS takes no action about the ASAC count until it receives the 200 (OK) response to the BYE whereupon the SS decrements the call count associated with the call being terminated.

6.5.4.2 *Inbound INVITE and re-INVITE*

6.5.4.2.1 *Inbound INVITE*

SIP-005650 When the SS receives an INVITE intended for a served SC, the SS takes no action about ASAC until it receives a response from the served SC and proceeds as follows:

SIP-005650.a If the INVITE had been an Empty INVITE (i.e., no sdp offer), then the SS increments the telephony count (or inbound telephony count) by one if one of the following occurs:

- The first provisional non-failure response (e.g., 1xx response code greater than a 100) has no sdp offer.
- The first provisional response has an sdp offering audio capabilities.
- The first response is a final response (200) with an sdp that offers audio capabilities.

NOTE: See [Section 8](#), Video Telephony – General Rules, for examples of how the SS modifies ASAC call count when the first provisional non-failure response has no sdp offer but the subsequent 200 final response offers audio and video capabilities.

SIP-005650.b If the INVITE had been an Empty INVITE (i.e., no sdp offer), then the SS increments the video call count (ore inbound video call count) by the appropriate number of VSUs if one of the following occur:

- The first provisional response has an sdp offering audio and video capabilities.
- The first response is a final response (200) with an sdp that offers audio and video capabilities.

SIP-005650.c If the INVITE had an sdp offer advertising audio capabilities only, then the SS increments the telephony count (or inbound telephony count) by one if one of the following occurs:

- The first provisional non-failure response (e.g., 1xx response code greater than a 100) has no sdp answer.
- The first provisional response has an sdp answer accepting audio capabilities.
- The first response is a final response (200) with an sdp that accepts audio capabilities.

SIP-005650.d If the INVITE had an sdp offer advertising audio and video capabilities, then the SS increments the telephony count (or inbound telephony count) by one if the first provisional non-failure response (e.g., 1xx response code greater than a 100 response code) has an sdp answer accepting audio only.

SIP-005650.e If the INVITE had an sdp offer advertising audio and video capabilities, then the SS increments the video count (or inbound video count) by the appropriate number of VSUs if one of the following occurs:

- The first provisional non-failure response (e.g., 1xx response code greater than a 100) has no sdp answer.
- The first provisional response has an sdp answer accepting audio and video capabilities.
- The first response is a final response (200) with an sdp that accepts audio and video capabilities.

NOTE: See [Section 8](#), Video Telephony – General Rules, for examples of how the SS modifies ASAC call count when the first provisional non-failure response has no sdp answer but the subsequent 200 final response accepts audio capabilities only.

SIP-005650.f If the response from the SC is a failure response (e.g., 4xx, 5xx, 6xx), then the SS takes no action with respect to ASAC.

6.5.4.2.2 *Inbound re-INVITE on Existing Telephony Call*

SIP-005660 When the SS receives a re-INVITE intended for a served SC AND the sdp offers audio and video capabilities AND the existing call is budgeted against the telephony call count, THEN the SS takes no action about ASAC until it receives a response from the served SC and proceeds as follows:

SIP-005660.a If the SS receives from its served SC a 200 response with an sdp answer that accepts the audio and video capabilities, then the SS increments the video call count (or inbound video call count) by the appropriate number of VSUs and decrements the telephony call count (or if the SC uses directionalization, then the SS decrements the outbound telephony call count or inbound telephony call count depending on the classification of the original call) by one.

SIP-005660.b If the SS receives from its served SC a failure response or a 200 response with an sdp answer that does not accept the video capabilities, then the SS makes no change to the ASAC call counts.

SIP-005670 When the SS receives a re-INVITE offering audio capabilities only and it is intended for a served SC AND the existing call is budgeted against the telephony call count, then the SS takes no action about ASAC and will make no change to the ASAC call counts upon receiving from the served SC either a 200 answer that accepts the audio offer or a 200 answer that rejects the audio offer or a final failure response.

6.5.4.2.3 *Inbound re-INVITE on Existing Video Call*

SIP-005680 When the SS receives a re-INVITE intended for a served SC that has an sdp offering audio capabilities only AND the existing call is budgeted against the video call count, then the SS takes no action about ASAC until it receives a response from the served SC and proceeds as follows:

SIP-005680.a If the SS receives from its served SC a 200 with an sdp answer that accepts the audio offer then the SS increments the telephony call count (or inbound telephony call count) by one and decrements the video call count (or if the SC uses directionalization then the SS decrements the outbound video call count or inbound video call count depending upon the classification of the original call) by the appropriate number of VSUs.

SIP-005680.b If the SS receives from its served SC a failure response or a 200 with an sdp answer that does not accept the video capabilities then the SS makes no change to the ASAC call counts.

SIP-005690 When the SS receives a re-INVITE intended for a served SC that offers audio and video capabilities AND the existing call is budgeted against the video call count (or the outbound video call count or inbound video call count in the case of directionalization), then the SS takes no action about ASAC until it receives a response from the served SC and proceeds as follows:

SIP-005690.a If the SS receives from its served SC a 200 response with an sdp answer that accepts the video offer, then:

SIP-005690.a.1 If the proposed video call count is greater than the current video call count the SS MUST increment the video call count (or if the SC uses

directionalization then the SS increments the outbound video call count or inbound video call count depending on the classification of the original call) by the difference in VSUs between the proposed video call count and the current video call count.

SIP-005690.a.2 If the proposed video call count is less than the current video call count, then upon receipt of the 200 response the SS reduces the video call count (or if the SC uses directionalization, then the SS decrements the outbound video call count or inbound video call count depending on the classification of the original call) by the difference in VSUs between the proposed video call count and the current video call count.

SIP-005690.a.3 If the SS receives from its served SC a failure response or a 200 response with an sdp answer that does not accept the video capabilities, then the SS makes no change to the ASAC call counts.

6.5.4.2.4 Inbound BYE

SIP-005700 When an SS receives a BYE request intended for a served SC, the SS takes no action about the ASAC count until it receives the 200 (OK) response to the BYE from its served SC whereupon the SS decrements the call count associated with the call being terminated.

SECTION 7 SS POLICING OF CALL COUNT THRESHOLDS

7.1 INTRODUCTION

SIP-005710 When a SS includes an SC component (i.e., the SS serves IP EIs), the SS is NOT required to conduct policing of its SC component.

SIP-005720 An SS MUST be provisioned with full knowledge of each network domain and the set of valid r-priority values for each given network domain supported by every one of its subtended SCs.

NOTE: The only valid network domains for the SBU network are “uc” and “dsn” and the valid r-priority values are “0” routine, “2” priority, “4” immediate, “6” flash, and “8” flash-override.

NOTE: The only valid network domain for the Classified network is “cuc” and the valid r-priority values are “0” routine, “2” priority, “4” immediate, “6” flash, “8” flash-override, and “9” flash-override-override.

7.2 POLICING OF TELEPHONY CALLS AND CALL REQUESTS

SIP-005730 For each SC served by a given SS, the SS MUST be provisioned with the following:

- IPB (the total budget of concurrent VoIP telephony calls and call requests that the SC is permitted over the access link at any given time).
- IPBo (the total budget of outbound VoIP telephony calls and call requests that the SC is permitted over the access link at any given time). Outbound VoIP telephony calls refer to calls initiated by EIs served by SC and destined for EIs located outside the originating B/P/C/S and reached over the WAN.
- IPBi (the total budget of inbound VoIP telephony calls and call requests that the SC is permitted over the access link at any given time). Inbound VoIP telephony calls refer to calls initiated by external EIs, received over the WAN, and destined for a local EI served by the SC.

SIP-005740 When there is no directionalization, then IPBo equals IPBi equals null, and when there is directionalization, then IPBo plus IPBi MUST equal IPB.

SIP-005750 Every SS MUST be provisioned with the value of the VoIP telephony call budgets IPB, IPBo, and IPBi for each SC served by the given SS. The VoIP telephony call budgets for a given SS MUST be updated whenever the VoIP telephony call budget for the corresponding SC is updated.

SIP-005760 For each SC served by an SS, the SS MUST continuously maintain a current accounting of the following:

- IPC – the total number of current telephony calls and outstanding telephony call requests for each SC served by the SS.
- IPCo – the total number of current outbound telephony calls and outstanding outbound telephony call requests for each SC served by the SS.
- IPCi – the total number of current inbound telephony calls and outstanding inbound telephony call requests for each SC served by the SS.

SIP-005770 Every SS MUST be provisioned with knowledge of any network domain ID and the associated legitimate r-priority values supported by one or more of its assigned SCs. This information MUST be updated as new network domain IDs are added by one or more of its assigned SCs.

7.2.1 Policing of Outbound Telephony Call Requests

7.2.1.1 Outbound INVITE and re-INVITE

SIP-005780 When the SS receives an outbound routine (r-priority equals “0”) INVITE for a telephony call (that is either an initial INVITE or a re-INVITE where the existing call is a video session) from a served SC that exceeds the telephony budget (the new call request means IPC is greater than IPB if no directionalization, or IPCo is greater than IPBo if directionalization) the SS MUST respond to the SC with a 488 (Not Acceptable Here) response code that MUST include a Warning header field with warning code 370 (Insufficient Bandwidth). An Empty INVITE is also classified as a telephony call. The SS takes no action with respect to ASAC in the case of a re-INVITE for a telephony call when the existing session is also a telephony call. The SS MUST notify the NMS whenever the SS rejects a routine telephony call request to compel adherence to a telephony call count threshold (see Requirements SIP-005860 and SIP-005870).

SIP-005790 The SS takes no action with respect to ASAC in the case of a re-INVITE for a telephony call when the existing session is also a telephony call. An Empty INVITE is also classified as a telephony call. When the SS receives an outbound precedence INVITE (i.e., priority level greater than routine) for a telephony call (that is either an initial INVITE or a re INVITE where the existing call is a video session) from a served SC that exceeds the telephony budget (the new call request means IPC is greater than IPB if no directionalization, or IPCo is greater than IPBo if directionalization) the SC MUST:

- In the case of no directionalization, preempt lower precedence telephony call requests and/or telephony calls to free up the necessary resources to support the precedence call request. (See Requirement SIP-005330.b for details on the selection process for preempting lower precedence call requests and calls.) The SS MUST notify the NMS whenever an SS performs a network preemption in the context of its Policing function to compel adherence to a telephony call count threshold (see Requirements SIP-005860 and SIP-005870). If the SS is

unable to preempt a call request or call on behalf of a precedence call request, then the SS MUST notify the NMS (see Requirements SIP-005860 and SIP-005870).

- In the case of directionalization, preempt lower precedence outbound telephony call requests and/or telephony calls to free up the necessary resources to support the precedence call request. (See Requirement SIP-005330.b for details on the selection process for preempting lower precedence call requests and calls.) The SS MUST notify the NMS whenever the SS performs a network preemption in the context of its Policing function to compel adherence to a telephony call count threshold (see Requirements SIP-005860 and SIP-005870). If the SS is unable to preempt a call request or call on behalf of a precedence call request, then SS MUST notify the NMS (see Requirements SIP-005860 and SIP-005870).

NOTE: An Empty INVITE is classified as a telephony call also.

SIP-005800 When the SS receives an outbound INVITE for a telephony call (that is either an initial INVITE⁴⁶ or a re-INVITE where the existing call is a video session⁴⁷) from a served SC that exceeds the telephony budget (the new call request means IPC is greater than IPB if no directionalization, or IPCo is greater than IPBo if directionalization) and the outbound INVITE either does not have a Require header or has a Require header but not the option tag “resource-priority” and has either an unrecognized network domain OR a known network domain but an invalid value for the r-priority field, then the SS MUST respond with a 488 (Not Acceptable Here) response code that MUST include a Warning header field with warning code 370 (Insufficient Bandwidth). An Empty INVITE is also classified as a telephony call. The SS MUST notify the NMS that a telephony call request has been rejected to compel adherence to a telephony call count threshold (see Requirements SIP-005860 and SIP-005870), and either an unknown network domain ID or invalid value for the r-priority field was encountered, as the case may be.

SIP-005810 When the SS receives an outbound INVITE for a telephony call (that is either an initial INVITE⁴⁸ or a re-INVITE where the existing call is a video session⁴⁹) from a served SC and the outbound INVITE has a Require header with the option tag “resource priority” and has a Resource-Priority header with an unrecognized network domain, then the SS MUST respond with a 417 (Unknown Resource-Priority) response code. The SS MUST notify the NMS that a telephony call request with an invalid network domain has been rejected to compel adherence to a telephony call count threshold (see Requirements SIP-005860 and SIP-005870) and that an unknown network domain ID was encountered.

⁴⁶ An Empty INVITE is also classified as a telephony call.

⁴⁷ The SS takes no action with respect to ASAC in the case of a re-INVITE for a telephony call when the existing session is also a telephony call.

⁴⁸ An Empty INVITE is also classified as a telephony call.

⁴⁹ The SS takes no action with respect to ASAC in the case of a re-INVITE for a telephony call when the existing session is also a telephony call.

SIP-005820 When the SS receives an outbound INVITE for a telephony call (that is either an initial INVITE⁵⁰ or a re-INVITE where the existing call is a video session⁵¹) from a served SC that exceeds the telephony budget (the new call request means IPC is greater than IPB if no directionalization, or IPCo is greater than IPBo if directionalization) and the outbound INVITE has a Require header with the option tag “resource-priority” and has a Resource-Priority header with a known network domain but an invalid value for the r-priority field, then the SS MUST respond with a 488 (Not Acceptable Here) response that MUST include a Warning header field with warning code 370 (Insufficient Bandwidth). The SS MUST notify the NMS that a telephony call request was rejected to compel adherence to a telephony call count threshold (see Requirements SIP-005860 and SIP-005870) and that an invalid value for the r-priority field was encountered.

7.2.2 Policing of Inbound Telephony Call Requests

7.2.2.1 Inbound INVITE With sdp

SIP-005830 When an SS receives an inbound initial INVITE that advertises audio capabilities for a served SC that is already at or in excess of its configured telephony budget (the new call request means IPC is greater than IPB if no directionalization, or IPCi is greater than IPBi if directionalization), then the SS MUST forward the INVITE to the SC.⁵² The inbound call request is NOT classified as a call request that goes against the telephony call count threshold unless and until a 1xx response code greater than a 100 or 2xx response is received by the SS from the served SC, and then proceeds as follows:

SIP-005830.a If the INVITE (in Requirement SIP-005830) had a ROUTINE (r priority equals “0”) priority AND the SS receives a 1xx response code greater than a 100 or 2xx response from its served SC, then the SS MUST:

- Send a 488 (Not Acceptable Here) response code to the remote initiating party of the AS-SIP INVITE that MUST include a Warning header field with warning code 370 (Insufficient Bandwidth).
- Send a CANCEL request (in the case of a 1xx response code) or a BYE request (in the case of a 2xx response code) to the local SC.
- Notify the NMS whenever a ROUTINE telephony call request is rejected to compel adherence to a telephony call count threshold (see Requirements SIP-005860 and SIP-005870).

⁵⁰ An Empty INVITE is also classified as a telephony call.

⁵¹ The SS takes no action with respect to ASAC in the case of a re-INVITE for a telephony call when the existing session is also a telephony call.

⁵² The SC has primary responsibility for ensuring that the access link is in compliance with the call count threshold.

SIP-005830.b If the INVITE (in Requirement SIP-005830) had a priority greater than ROUTINE (i.e., a precedence call) AND the SS receives a 1xx response code greater than a 100 or 2xx response from its served SC, then the SS MUST:

- In the case of no directionalization, preempt lower precedence telephony call requests and/or telephony calls to free up the necessary resources to support the precedence call request. (See Requirement SIP-005330.b for details on the selection process for preempting lower precedence call requests and calls.) The SS MUST notify the NMS whenever the SS performs a network preemption in the context of its Policing function to compel adherence to a telephony call count threshold (see Requirement SIP-005880).⁵³
- In the case of directionalization, preempt lower precedence inbound telephony call requests and/or telephony calls to free up the necessary resources to support the precedence call request. (See Requirement SIP-005330.b for details on the selection process for preempting lower precedence call requests and calls.) The SS MUST notify the NMS whenever the SS performs a network preemption in the context of its Policing function to compel adherence to a telephony call count threshold (see Requirement SIP-005880).⁵⁴

SIP-005830.c If the INVITE (in Requirement SIP-005830) did not have a Require header or had a Require header but not the option tag “resource-priority” AND the SS does not recognize the network domain or recognizes the network domain but the r-priority field does not have a valid value for the given network domain and the served SC responds with a 1xx response code greater than a 100 or 2xx, then the SS MUST:

- Send a 488 (Not Acceptable Here) response code to the remote initiating party of the AS-SIP INVITE that MUST include a Warning header field with Warning code 370 (Insufficient Bandwidth).
- Send a CANCEL request (in the case of a 1xx response code) or a BYE request (in the case of a 2xx response code) to the local SC.
- Notify the NMS that a telephony call request was rejected to compel adherence to a telephony call count threshold (see Requirements SIP-005860 and SIP-005870) and that an unknown network domain ID or an invalid value for the r-priority field was encountered, as the case may be.

SIP-005830.d If the INVITE (in Requirement SIP-005830) had a Require header with the option tag “resource-priority” AND does not recognize the value of the network domain and the served SC responds with a 1xx response code greater than a 100 or 2xx, then the SS MUST:

⁵³ If the SS is unable to preempt a call request or call on behalf of a precedence call request, then the SS MUST notify the NMS (see Requirements SIP-005860 and SIP-005870).

⁵⁴ If the SS is unable to preempt a call request or call on behalf of a precedence call request, then the SS MUST notify the NMS (see Requirements SIP-005860 and SIP-005870).

- Send a 417 (Unknown Resource-Priority) response code to the remote initiating party.
- Send a CANCEL request (in the case of a 1xx response code) or a BYE request (in the case of a 2xx response code) to the local SC.
- Notify the NMS that a telephony call request was rejected to compel adherence to a telephony call count threshold (see Requirements SIP-005860 and SIP-005870) and that an unknown network domain ID was encountered.

SIP-005830.e If the INVITE (in Requirement SIP-005830) had a Require header with the option tag “resource-priority” AND recognizes the network domain but the r-priority field does not have a valid value for the given network domain AND the served SC responds with a 1xx response code greater than a 100 or 2xx, then the SS MUST:

- Send a 488 (Not Acceptable Here) response code to the remote initiating party of the AS-SIP INVITE that MUST include a Warning header field with warning code 370 (Insufficient Bandwidth).
- Send a CANCEL request (in the case of a 1xx response code) or a BYE request (in the case of a 2xx response code) to the local SC.
- Notify the NMS that a telephony call request was rejected to compel adherence to a telephony call count threshold (see Requirements SIP-005860 and SIP-005870) and notify the NMS that an invalid value for the r-priority field was encountered.

7.2.2.2 Inbound Empty INVITE

SIP-005840 When an SS receives an inbound Empty INVITE for a served SC that is already at or in excess of its configured telephony budget (the new call request means IPC is greater than IPB if no directionalization, or IPCi is greater than IPBi if directionalization), then the SS MUST forward the INVITE to the SC.⁵⁵

SIP-005840.a If the Empty INVITE (in Requirement SIP-005840) had a priority level of ROUTINE (r-priority equals “0”) AND the SS receives either a 1xx response code greater than a 100 response having no sdp offer, a 1xx response code greater than a 100 response with an sdp offering audio capabilities only, or a 200 response with an sdp offering audio capabilities only, then the SS MUST:

- Send a 488 (Not Acceptable Here) response code to the remote initiating party of the AS-SIP INVITE that MUST include a Warning header field with warning code 370 (Insufficient Bandwidth).
- Send a CANCEL request (in the case of a 1xx response code) or a BYE request (in the case of a 2xx response code) to the local SC.

⁵⁵ The SC has primary responsibility for ensuring that the access link is in compliance with the call count threshold.

- Notify the NMS whenever a ROUTINE level telephony call request is rejected to compel adherence to a telephony call count threshold (see Requirements SIP-005860 and SIP-005870).

SIP-005840.b If the Empty INVITE (in Requirement SIP-005840) had a priority level of ROUTINE (r-priority equals “0”) AND the SS receives either a 1xx response code greater than a 100 response with an sdp offering audio and video or a 200 response with an sdp offering audio and video capabilities AND the VSUs required for the new video session exceeds the video budget (the new session request means VDC greater than VDB if no directionalization, or VDC_i greater than VDB_i if directionalization), then the SS MUST:

- Send a 488 (Not Acceptable Here) response code to the remote initiating party of the AS-SIP INVITE that MUST include a Warning header field with Warning code 370 (Insufficient Bandwidth).
- Send a CANCEL request (in the case of a 1xx response code) or a BYE request (in the case of a 2xx response code) to the local SC.
- Notify the NMS whenever a ROUTINE video session request is rejected to compel adherence to a telephony call count threshold (see Requirements SIP-005860 and SIP-005870).

SIP-005840.c If the Empty INVITE (in Requirement SIP-005840) was a precedence call request (i.e., had a priority level greater than ROUTINE) AND the SS receives either a 1xx response code greater than a 100 response having no sdp offer, a 1xx response code greater than a 100 response with an sdp offering audio capabilities only, or a 200 response with an sdp offering audio capabilities only, then the SS MUST:

- In the case of no directionalization, preempt lower precedence telephony call requests and/or telephony calls to free up the necessary resources to support the precedence call request. (See Requirement SIP-005840.b for details on the selection process for preempting lower precedence call requests and calls.) The SS MUST notify the NMS whenever the SS performs a network preemption in the context of its Policing function to compel adherence to a telephony call count threshold (see Requirement SIP-005880).⁵⁶
- In the case of directionalization, preempt lower precedence inbound telephony call requests and/or telephony calls to free up the necessary resources to support the precedence call request. (See Requirement SIP-005840.b for details on the selection process for preempting lower precedence call requests and calls.) The SS MUST notify the NMS whenever the SS performs a network preemption in the context of its

⁵⁶ If the SS is unable to preempt a call request or call on behalf of a precedence call request, then the SS MUST notify the NMS (see Requirements SIP-005860 and SIP-005870).

Policing function to compel adherence to a telephony call count threshold (see Requirement SIP-005880).⁵⁷

SIP-005840.d If the Empty INVITE (in Requirement SIP-005840) had a priority level greater than ROUTINE (i.e., a precedence call) AND the SS receives either a 1xx response code greater than a 100 response with an sdp offering audio and video capabilities or a 200 response with an sdp offering both audio and video capabilities AND the VSUs required for the new video session exceeds the video budget (the new session request means VDC is greater than VDB if no directionalization, or VDCi greater than VDBi if directionalization), then the SS MUST:

- In the case of no directionalization, preempt lower precedence video session requests and/or video sessions to free up the necessary resources to support the precedence session request. (See Requirement SIP-005330.b for details on the selection process for preempting lower precedence call requests and calls.) The SS MUST notify the NMS whenever the SS performs a network preemption in the context of its Policing function to compel adherence to a video session count threshold (see Requirement SIP-005880).⁵⁸
- In the case of directionalization, preempt lower precedence outbound video session requests and/or video session to free up the necessary resources to support the precedence session request. (See Requirement SIP-005330.b for details on the selection process for preempting lower precedence call requests and calls.) The SS MUST notify the NMS whenever the SS performs a network preemption in the context of its Policing function to compel adherence to a video session count threshold (see Requirement SIP-005880).⁵⁹

SIP-005840.e If the Empty INVITE (in Requirement SIP-005840) did not have a Require header or had a Require header but not the option tag “resource-priority” AND the SS does not recognize the network domain or recognizes the network domain but the r-priority field does not have a valid value for the given network domain and the served SC responds with either a 1xx response code greater than a 100 having no sdp offer, a 1xx response code greater than a 100 with an sdp offering audio capabilities only, or a 200 response with an sdp offering audio capabilities only, then the SS MUST:

- Send a 488 (Not Acceptable Here) response code to the remote initiating party of the AS-SIP INVITE that MUST include a Warning header field with Warning code 370 (Insufficient Bandwidth).

⁵⁷ If the SS is unable to preempt a call request or call on behalf of a precedence call request, then the SS MUST notify the NMS (see Requirements SIP-005860 and SIP-005870)

⁵⁸ If the SS is unable to preempt a call request or call on behalf of a precedence call request, then the SS MUST notify the NMS (see Requirements SIP-005860 and SIP-005870)

⁵⁹ If the SS is unable to preempt a call request or call on behalf of a precedence call request, then the SS MUST notify the NMS (see Requirements SIP-005860 and SIP-005870)

- Send a CANCEL request (in the case of a 1xx response code) or a BYE request (in the case of a 2xx response code) to the local SC.
- Notify the NMS that a telephony call request was rejected to compel adherence to a telephony call count threshold (see Requirements SIP-005860 and SIP-005870) and that an unknown network domain ID or an invalid value for the r-priority field was encountered, as the case may be.

SIP-005840.f If the Empty INVITE (in Requirement SIP-005840) did not have a Require header or had a Require header but not the option tag “resource-priority” AND the SS does not recognize the network domain or recognizes the network domain but the r-priority field does not have a valid value for the given network domain and the served SC responds with either a 1xx response code greater than a 100 with an sdp offering audio and video capabilities or a 200 response with an sdp offering audio and video capabilities AND the VSUs required for the new video session exceeds the video budget (the new session request means VDC is greater than VDB if no directionalization, or VDCi is greater than VDBi if directionalization), then the SS MUST:

- Send a 488 (Not Acceptable Here) response code to the remote initiating party of the AS-SIP INVITE that MUST include a Warning header field with Warning code 370 (Insufficient Bandwidth).
- Send a CANCEL request (in the case of a 1xx response code) or a BYE request (in the case of a 2xx response code) to the local SC.
- Notify the NMS that a video call request was rejected to compel adherence to a video session count threshold (see Requirements SIP-006030 and SIP-006040) and that an unknown network domain ID or an invalid value for the r-priority field was encountered, as the case may be.

SIP-005840.g If the Empty INVITE (in Requirement SIP-005840) had a Require header with the option tag “resource-priority” AND does not recognize the value of the network domain AND the served SC responds with either a 1xx response code greater than a 100 having no sdp offer, a 1xx response code greater than a 100 with an sdp offering audio capabilities only, or a 200 response with an sdp offering audio capabilities only, then the SS MUST:

- Send a 417 (Unknown Resource-Priority) response code to the remote initiating party.
- Send a CANCEL request (in the case of a 1xx response code) or a BYE request (in the case of a 2xx response code) to the local SC.
- Notify the NMS that a telephony call request was rejected to compel adherence to a telephony call count threshold (see Requirements SIP-005860 and SIP-005870) and that an unknown network domain ID was encountered.

SIP-005840.h If the Empty INVITE (in Requirement SIP-005840) had a Require header with the option tag “resource-priority” AND does not recognize the value of the network

domain AND the served SC responds with either a 1xx response code greater than a 100 with an sdp offering audio and video capabilities or a 200 response with an sdp offering audio and video capabilities AND the VSUs required for the new video session exceeds the video budget (the new session request means VDC is greater than VDB if no directionalization, or VDCi is greater than VDBi if directionalization), then the SS MUST:

- Send a 417 (Unknown Resource-Priority) response code to the remote initiating party.
- Send a CANCEL request (in the case of a 1xx response code) or a BYE request (in the case of a 2xx response code) to the local SC.
- Notify the NMS that a telephony call request was rejected to compel adherence to a video session count threshold (see Requirements SIP-006030 and SIP-006040) and that an unknown network domain ID was encountered.

SIP-005840.i If the Empty INVITE (in Requirement SIP-005840) had a Require header with the option tag “resource-priority” AND recognizes the network domain but the r-priority field does not have a valid value for the given network domain AND the served SC responds with either a 1xx response code greater than a 100 having no sdp offer, a 1xx response code greater than a 100 with an sdp offering audio capabilities only, or a 200 response with an sdp offering audio capabilities only, then the SS MUST:

- Send a 488 (Not Acceptable Here) response code to the remote initiating party of the AS-SIP INVITE that SHOULD include a Warning header field with warning code 370 (Insufficient Bandwidth).
- Send a CANCEL request (in the case of a 1xx response code) or a BYE request (in the case of a 2xx response code) to the local SC.
- Notify the NMS that a telephony call request was rejected to compel adherence to a telephony call count threshold (see Requirements SIP-005860 and SIP-005870) and notify the NMS that an invalid value for the r priority field was encountered.

SIP-005840.j If the Empty INVITE (in Requirement SIP-005840) had a Require header with the option tag “resource-priority” AND recognizes the network domain but the r-priority field does not have a valid value for the given network domain AND the served SC responds with either a 1xx response code greater than a 100 with an sdp offering audio and video capabilities or a 200 response with an sdp offering audio and video capabilities AND the VSUs required for the new video session exceeds the video budget (the new session request means VDC is greater than VDB if no directionalization, or VDCi is greater than VDBi if directionalization), then the SS MUST:

- Send a 488 (Not Acceptable Here) response code to the remote initiating party of the AS-SIP INVITE that MUST include a Warning header field with warning code 370 (Insufficient Bandwidth).

- Send a CANCEL request (in the case of a 1xx response code) or a BYE request (in the case of a 2xx response code) to the local SC.
- Notify the NMS that a telephony call request was rejected to compel adherence to a video session count threshold (see Requirements SIP-006030 and SIP-006040) and notify the NMS that an invalid value for the r-priority field was encountered.

7.2.2.3 Inbound re-INVITE

SIP-005850 When an SS receives an inbound re-INVITE (where the existing call is a video session) that advertises audio capabilities only for a served SC that is already at or in excess of its configured telephony budget (the new call request means IPC is greater than IPB if no directionalization, or IPCi is greater than IPBi if directionalization), then the SS MUST forward the INVITE to the SC.⁶⁰ The inbound call request is NOT classified as a call request that goes against the telephony call count threshold unless and until a 200 response with an sdp answer accepting the audio offer is received by the SS from the served SC, and then proceeds as follows:

SIP-005850.a If the re-INVITE (in Requirement SIP-005850) had a priority level of ROUTINE (r-priority equals “0”) AND the SS receives the 200 response accepting the audio offer in Requirement SIP-005850 from its served SC, then the SS MUST:

- Send a 488 (Not Acceptable Here) response code to the remote initiating party of the INVITE that MUST include a Warning header field with warning code 370 (Insufficient Bandwidth).
- Send a BYE request to the remote initiating party of the AS-SIP re-INVITE.
- Send a BYE request to the local SC.
- Notify the NMS whenever a ROUTINE telephony call request is rejected to compel adherence to a telephony call count threshold (see Requirements SIP-005860 and SIP-005870).

SIP-005850.b If the re-INVITE (in Requirement SIP-005850) had a priority level greater than ROUTINE (i.e., a precedence call) AND the SS receives the 200 response accepting the audio offer in Requirement SIP-005850 from its served SC, then the SS MUST:

- In the case of no directionalization, preempt lower precedence telephony call requests and/or telephony calls to free up the necessary resources to support the precedence call request. (See Requirement SIP-005330.b for details on the selection process for preempting lower precedence call requests and calls.) The SS MUST notify the NMS whenever the SS performs a network preemption in the context of its Policing

⁶⁰ The SC has primary responsibility for ensuring that the access link is in compliance with the call count threshold.

function to compel adherence to a telephony call count threshold (see Requirement SIP-005880).⁶¹

- In the case of directionalization, preempt lower precedence inbound telephony call requests and/or telephony calls to free up the necessary resources to support the precedence call request. (See Requirement SIP-005330.b for details on the selection process for preempting lower precedence call requests and calls.) The SS MUST notify the NMS whenever the SS performs a network preemption in the context of its Policing function to compel adherence to a telephony call count threshold (see Requirement SIP-005880).⁶²

SIP-005850.c If the re-INVITE (in SIP-005850) did not have a Require header or had a Require header but not the option tag “resource-priority” AND the SS does not recognize the network domain or recognizes the network domain but the r priority field does not have a valid value for the given network domain and the served SC responds with the 200 response accepting the audio offer in Requirement SIP-005850, then the SS MUST:

- Send a 488 (Not Acceptable Here) response code to the remote initiating party of the AS-SIP INVITE that MUST include a Warning header field with warning code 370 (Insufficient Bandwidth).
- Send a BYE request to the remote initiating party of the AS-SIP re-INVITE.
- Send a BYE request to the locaSC.
- Notify the NMS that a telephony call request was rejected to compel adherence to a telephony call count threshold (see Requirements SIP-005860 and SIP-005870) and that an unknown network domain ID or an invalid value for the r priority field was encountered, as the case may be.

SIP-005850.d If the re-INVITE (in Requirement SIP-005850) had a Require header with the option tag “resource-priority” AND does not recognize the value of the network domain and the served SC responds with the 200 response in Requirement SIP-005850, then the SS MUST:

- Send a 417 (Unknown Resource-Priority) response code to the remote initiating party.
- Send a BYE request to the remote initiating party of the re-INVITE
- Send a BYE request to the local SC.
- Notify the NMS that a telephony call request was rejected to compel adherence to a telephony call count threshold (see Requirements SIP-005860 and SIP-005870) and that an unknown network domain ID was encountered.

⁶¹ If the SS is unable to preempt a call request or call on behalf of a precedence call request, then the SS MUST notify the NMS (see Requirements SIP-005860 and SIP-005870).

⁶² If the SS is unable to preempt a call request or call on behalf of a precedence call request, then the SS MUST notify the NMS (see Requirements SIP-005860 and SIP-005870).

SIP-005850.e If the re-INVITE (in Requirement SIP-005850) had a Require header with the option tag “resource-priority” AND recognizes the network domain but the r priority field does not have a valid value for the given network domain AND the served SC responds with the 200 response accepting the audio offer in Requirement SIP-005850, then the SS MUST:

- Send a 488 (Not Acceptable Here) response code to the remote initiating party of the AS-SIP INVITE that MUST include a Warning header field with warning code 370 (Insufficient Bandwidth).
- Send a BYE request to the remote initiating party of the AS-SIP re-INVITE.
- Send a BYE request to the local SC.
- Notify the NMS that a telephony call request was rejected to compel adherence to a telephony call count threshold (see Requirements SIP-005860 and SIP-005870) and notify the NMS that an invalid value for the r priority field was encountered.

7.2.3 Notification to the NMS

SIP-005860 The SS MUST notify the NMS whenever a routine or precedence telephony call request is rejected to compel adherence to a telephony call count threshold pursuant to the Policing function or whenever a telephony call request or telephony call is preempted pursuant to the Policing function.⁶³

SIP-005870 The notification to the NMS regarding the rejection of a telephony call request pursuant to the SS Policing function MUST include the following:

- The date and time of the rejection of the telephony call request.
- The calling party number and called party number of the rejected call request.
- The precedence level of the rejected call request.
- The identity of the SC that had the telephony call count threshold is being protected.
- The direction of the call request (inbound or outbound).

SIP-005880 The notification to the NMS regarding the preemption of a telephony call request or telephony call pursuant to the SS Policing function MUST include the following:

- The date and time of receipt of the precedence call request.
- The calling party number and called party number of the precedence call request.
- The precedence level of the precedence call request.
- The date and time of the preemption of the telephony call request or call.

⁶³ The network management requirements will dictate the nature of the notification (e.g., SNMP trap or alarm) and the specific format of the notification.

- The calling party number and called party number of the preempted call request or call.
- The precedence level of the preempted call request or call.
- The identity of the SC that had the telephony call count threshold is being protected.
- The direction of the call request (inbound or outbound).

7.2.4 Operational Adjustments

SIP-005890 Although outside the scope of this specification, the telephony call count threshold at the SS MAY be set to a value slightly above the mandated telephony call count threshold for the corresponding SC. This procedure creates a safety margin for avoidance of call rejection or preemption due to the possibility of transient race conditions.

7.3 POLICING OF VIDEO SESSIONS AND SESSION REQUESTS

SIP-005900 Video sessions are budgeted in terms of VSUs where one VSU equals 500 Kbps and bandwidth for video sessions is allocated in multiples of VSUs.

SIP-005910 For each SC served by a given SS, the SS MUST be provisioned with the following:

- VDB (the total budget of VSUs that the SC is permitted to concurrently allocate for video sessions and video session requests over the access link at any given time).
- VDBo (the total budget of outbound VSUs that the SC is permitted to concurrently allocate for video sessions and video session requests over the access link at any given time).
- VDBi (the total budget of inbound VSUs that the SC is permitted to concurrently allocate for video sessions and video session requests over the access link at any given time).

SIP-005920 When there is no directionalization, then VDPBo equals VDBi equals null, and when there is directionalization, then VDBo plus VDBi MUST equal VPB.

SIP-005930 Every SS MUST be provisioned with the value of the VoIP video session budgets VDB, VDBo, and VDBi for each SC served by the given SS. The VoIP video session budgets for a given SS MUST be updated whenever the VoIP video session budget for the corresponding SC is updated.

SIP-005940 For each SC served by a SS, the SS MUST continuously maintain a current accounting of the following:

- VDC (the total number of VSUs being consumed by the current video sessions and reserved for outstanding video session requests for each SC served by the SS).
- VDCo (the total number of VSUs being consumed by the current outbound video sessions and reserved for outstanding outbound video session requests for each signaling appliance served by the SS).

- VDC_i (the total number of VSUs being consumed by the current inbound video sessions and reserved for outstanding inbound video session requests for each SC served by the SS).

SIP-005950 Every SS MUST be provisioned with knowledge of the network domain IDs and the associated legitimate r priority values supported by one or more of its assigned SCs. This information MUST be updated as new network domain IDs are added by one or more of its assigned SCs.

7.3.1 Policing of Outbound Video Session Requests

SIP-005960 When the SS receives an outbound routine (r priority equals “0”) INVITE from a served SC offering audio and video capabilities that exceeds the video budget (or outbound video budget in the case of directionalization) or receives a re-INVITE offering a video session from a served SC that exceeds the video budget⁶⁴, then the SS MUST respond to the SC with a 488 (Not Acceptable Here) response code that MUST include a Warning header field with Warning code 370 (Insufficient Bandwidth). The SS MUST notify the NMS whenever the SS rejects a ROUTINE video session request to compel adherence to a video count threshold (see Requirements SIP-006030 and SIP-006040).

SIP-005970 When the SS receives an outbound INVITE with a priority greater than ROUTINE (i.e., a precedence call) from a served SC offering audio and video capabilities that exceeds the video budget (or outbound video budget in the case of directionalization) or receives a re INVITE offering a video session from a served SC that exceeds the video budget⁶⁵, the SS MUST do the following:

- In the case of no directionalization, preempt lower precedence video session requests and/or video sessions to free up the necessary resources to support the precedence session request. (See Requirement SIP-005330.b for details on the selection process for preempting lower precedence session requests and sessions). The SS MUST notify the NMS whenever the SS performs a network preemption in the context of its Policing function to compel adherence to a video count threshold (see Requirement SIP-006050).⁶⁶

⁶⁴ For a re-INVITE, in the case of directionalization, if the existing call is a telephony call, then the new video session is applied to the outbound video session count; if the existing call is an outbound video session, then policing occurs when the new video session request uses more VSUs than the current video session and the additional VSUs would exceed VDB_o; if the existing session is an inbound video session, then policing occurs when the new video session request uses more VSUs than the current video session and the additional VSUs would exceed VDB_i.

⁶⁵ For a re-INVITE, in the case of directionalization, if the existing call is a telephony call, then the new video session is applied to the outbound video session count; if the existing call is an outbound video session, then policing occurs when the new video session request uses more VSUs than the current video session and the additional VSUs would exceed VDB_o; if the existing session is an inbound video session, then policing occurs when the new video session request uses more VSUs than the current video session and the additional VSUs would exceed VDB_i.

⁶⁶ If the SS is unable to preempt a call request or call on behalf of a precedence call request, then the SS MUST notify the NMS (see Requirements SIP-006030 and SIP-006040).

- In the case of directionalization where the INVITE is either an initial INVITE or a re-INVITE where the existing call is a telephony call, then preempt lower precedence outbound video session requests and/or video sessions to free up the necessary resources to support the precedence session request. (See Requirement SIP-005330.b for details on the selection process for preempting lower precedence session requests and sessions). The SS MUST notify the NMS whenever the SS performs a network preemption in the context of its Policing function to compel adherence to a video count threshold (see Requirement SIP-006050)⁶⁷.
- In the case of directionalization where the INVITE is a re-INVITE and the existing call is an outbound video session, then preempt lower precedence outbound video session requests and/or video sessions to free up the necessary resources to support the precedence session request. (See Requirement SIP-005330.b for details on the selection process for preempting lower precedence session requests and sessions). The SS MUST notify the NMS whenever the SS performs a network preemption in the context of its Policing function to compel adherence to a video count threshold (see Requirement SIP-005880).⁶⁸
- In the case of directionalization where the INVITE is a re-INVITE and the existing call is an inbound video session, then preempt lower precedence inbound video session requests and/or video sessions to free up the necessary resources to support the precedence session request. (See Requirement SIP-005330.b for details on the selection process for preempting lower precedence session requests and sessions). The SS MUST notify the NMS whenever the SS performs a network preemption in the context of its Policing function to compel adherence to a video count threshold (see Requirement SIP-005880).⁶⁹

SIP-005980 When the SS receives an outbound INVITE from a served SC offering audio and video capabilities that exceeds the video budget (or outbound video budget in the case of directionalization) or receives a re-INVITE offering a video session from a served SC that exceeds the video budget⁷⁰ and the outbound INVITE (or re-INVITE) either does not have a Require header or has a Require header but not the option tag “resource-priority” and has either an unrecognized network domain OR a known network domain but an invalid value for the r-priority field, then the SS MUST respond to the SC with a 488 (Not Acceptable Here) response code that MUST include a Warning header field with warning code 370 (Insufficient Bandwidth). The SS MUST notify the NMS that a video session request was rejected to compel

⁶⁷ If the SS is unable to preempt a call request or call on behalf of a precedence call request, then the SS MUST notify the NMS (see Requirements SIP-006030 and SIP-006040).

⁶⁸ If the SS is unable to preempt a call request or call on behalf of a precedence call request, then the SS MUST notify the NMS (see Requirements SIP-006030 and SIP-006040).

⁶⁹ If the SS is unable to preempt a call request or call on behalf of a precedence call request then the SS MUST notify the NMS (see Requirements SIP-006030 and SIP-006040).

⁷⁰ For a re-INVITE, in the case of directionalization, if the existing call is a telephony call, then the new video session is applied to the outbound video session count; if the existing call is an outbound video session, then policing occurs when the new video session request uses more VSUs than the current video session and the additional VSUs would exceed VDB_o ; if the existing session is an inbound video session, then policing occurs when the new video session request uses more VSUs than the current video session and the additional VSUs would exceed VDB_i .

adherence to a video count threshold (see Requirements SIP-006030 and SIP-006040) and that either an unknown network domain ID or an invalid value for the r priority field was encountered, as the case may be.

SIP-005990 When the SS receives an outbound INVITE from a served SC offering audio and video capabilities or receives a re-INVITE offering a video session from a served SC and the outbound INVITE (or re-INVITE) has a Require header with the option tag “resource priority” and has a Resource-Priority header with an unrecognized network domain, then the SS MUST respond with a 417 (Unknown Resource-Priority) response. The SS MUST notify the NMS that a video session request was rejected to compel adherence to a video count threshold (see Requirements SIP-006030 and SIP-006040) and that an unknown network domain ID was encountered.

SIP-006000 When the SS receives an outbound INVITE from a served SC offering audio and video capabilities that exceeds the video budget (or outbound video budget in the case of directionalization) or receives a re-INVITE offering a video session from a served SC that exceeds the video budget⁷¹ and the outbound INVITE (or re-INVITE) has a Require header with the option tag “resource-priority” and has a Resource-Priority header with a known network domain but an invalid value for the r-priority field, then the SS MUST respond with a 488 (Not Acceptable Here) response that MUST include a Warning header field with warning code 370 (Insufficient Bandwidth). The SS MUST notify the NMS that a video session request was rejected to compel adherence to a video count threshold (see Requirements SIP-006030 and SIP-006040) and that an invalid value for the r-priority field was encountered.

NOTE: Outbound Empty INVITEs are classified as telephony calls and their policing is covered in Requirements SIP-005780 through SIP-005820.

7.3.2 Policing of Inbound Video Session Requests

7.3.2.1 Inbound INVITE

SIP-006010 When a SS receives an inbound INVITE that advertises audio and video capabilities for a served SC that is already at or in excess of its configured budget (the new session request means VDC is greater than VDB if no directionalization, or VDCi is greater than VDBi if directionalization), then the SS MUST forward the INVITE to the SC⁷². The inbound call request is NOT classified as a call request that goes against the video call count threshold (or telephony call count threshold) unless and until a 1xx response code greater than a 100 or 2xx response is received by the SS from the served SC, and then proceeds as follows:

⁷¹ For a re-INVITE, in the case of directionalization, if the existing call is a telephony call, then the new video session is applied to the outbound video session count; if the existing call is an outbound video session, then policing occurs when the new video session request uses more VSUs than the current video session and the additional VSUs would exceed VDB_o; if the existing session is an inbound video session, then policing occurs when the new video session request uses more VSUs than the current video session and the additional VSUs would exceed VDB_i.

⁷² The SC has primary responsibility for ensuring that the access link is in compliance with the call count threshold.

SIP-006010.a In the event the INVITE (in SIP-006010) had a ROUTINE priority level AND the SS receives a 1xx response code greater than a 100 response or 2xx response with an sdp answer that accepts audio and video capabilities (and that would cause the video count to exceed the threshold) or a 1xx response code greater than a 100 response with no sdp answer from its served SC, then the SS MUST do the following:

- Send a 488 (Not Acceptable Here) response code to the remote initiating party of the INVITE that MUST include a Warning header field with warning code 370 (Insufficient Bandwidth).
- Send a CANCEL request (in the case of a 1xx response code) or a BYE request (in the case of a 2xx response code) to the local SC.
- Notify the NMS whenever a ROUTINE level video session request is rejected to compel adherence to a video count threshold (see Requirements SIP-006030 and SIP-006040).

SIP-006010.b In the event the INVITE (in Requirement SIP-006010) had a priority level greater than ROUTINE (i.e., a precedence call) AND the SS receives a 1xx response code greater than a 100 response or 2xx response with an sdp answer that accepts audio and video capabilities (and that would cause the video count to exceed the threshold) or a 1xx response code greater than a 100 response with no sdp answer, then the SS MUST do the following:

- In the case of no directionalization, preempt lower precedence video session requests and/or video sessions to free up the necessary resources to support the precedence session request. (See Requirement SIP-005330.b for details on the selection process for preempting lower precedence session requests and sessions). The SS MUST notify the NMS whenever the SS performs a network preemption in the context of its Policing function to compel adherence to a video count threshold (see Requirement SIP-006050).⁷³
- In the case of directionalization, preempt lower precedence inbound video session requests and/or video sessions to free up the necessary resources to support the precedence session request. (See Requirement SIP-005330.b for details on the selection process for preempting lower precedence session requests and sessions). The SS MUST notify the NMS whenever the SS performs a network preemption in the context of its Policing function to compel adherence to a video count threshold (see Requirement SIP-006050).

SIP-006010.c In the event the INVITE (in Requirement SIP-006010) did not have a Require header or had a Require header but not the option tag “resource-priority” AND the SS does not recognize the network domain or recognizes the network domain but the r-priority field does not have a valid value for the given network domain and the served

⁷³ If the SS is unable to preempt a call request or call on behalf of a precedence call request, then SS MUST notify the NMS (see Requirements SIP-006030 and SIP-006040).

SC responds with a 1xx response code greater than a 100 response or a 2xx response code with an sdp answer that accepts either audio and video capabilities (and that would cause the video count to exceed the threshold) or a 1xx response code greater than a 100 response with no sdp answer, then the SS MUST do the following:

- Send a 488 (Not Acceptable Here) response code to the remote initiating party of the re-INVITE that MUST include a Warning header field with warning code 370 (Insufficient Bandwidth).
- Send a CANCEL request (in the case of a 1xx response code) or a BYE request (in the case of a 2xx response code) to the local AS-SIP signaling appliance.
- Notify the NMS that a video session request was rejected to compel adherence to a video count threshold (see Requirements SIP-006030 and SIP-006040) and that either an unknown network domain ID or an invalid value for the r-priority field was encountered, as the case may be.

SIP-006010.d In the event the INVITE (in Requirement SIP-006010) had a Require header with the option tag “resource-priority” AND does not recognize the value of the network domain and the served SC responds with a 1xx response code greater than a 100 or 2xx response with an sdp answer that accepts audio and video capabilities (and that would cause the video count to exceed the threshold) or a 1xx response code greater than a 100 response with no sdp answer then the SS MUST do the following:

- Send a 417 (Unknown Resource-Priority) response code to the remote initiating party.
- Send a CANCEL request (in the case of a 1xx response code) or a BYE request (in the case of a 2xx response code) to the local AS-SIP signaling appliance.
- Notify the NMS that a video session request was rejected to compel adherence to a video count threshold (see Requirements SIP-006030 and SIP-006040) and that an unknown network domain ID was encountered.

SIP-006010.e In the event the INVITE (in Requirement SIP-006010) had a Require header with the option tag “resource-priority” AND recognizes the network domain but the r priority field does not have a valid value for the given network domain AND the served SC responds with a 1xx response code greater than a 100 or 2xx response code with an sdp answer that accepts audio and video capabilities (and that would cause the video count to exceed the threshold), or a 1xx response code greater than a 100 response with no sdp answer, then the SS MUST do the following:

- Send a 488 (Not Acceptable Here) response code to the remote initiating party of the re-INVITE that MUST include a Warning header field with warning code 370 (Insufficient Bandwidth).
- Send a CANCEL request (in the case of a 1xx response code) or a BYE request (in the case of a 2xx response code) to the local SC.

- Notify the NMS that a video session request was rejected to compel adherence to a video count threshold (see Requirements SIP-006030 and SIP-006040) and that an invalid value for the r-priority field was encountered.

SIP-006010.f In the event the INVITE (in Requirement SIP-006010) had a ROUTINE priority level AND the SS receives a 1xx response code greater than a 100 response or a 2xx response with an sdp answer that accepts audio capabilities only from its served SC, then the SS MUST verify whether the call request would cause IPC to exceed IPB (or in the case of directionalization if IPCi would exceed IPBi). If the call request would cause the call count to exceed the telephony call count threshold, then the SS MUST do the following:

- Send a 488 (Not Acceptable Here) response code to the remote initiating party of the INVITE that MUST include a Warning header field with warning code 370 (Insufficient Bandwidth).
- Send a CANCEL request (in the case of a 1xx response code) or a BYE request (in the case of a 2xx response code) to the local SC.
- Notify the NMS whenever a ROUTINE level telephony request is rejected to compel adherence to a telephony count threshold (see Requirements SIP-006030 and SIP-006040).

SIP-006010.g If the INVITE (in Requirement SIP-006010) had a priority level greater than ROUTINE (i.e., a precedence call) AND the SS receives a 1xx response code greater than a 100 response or a 2xx response with an sdp answer that accepts audio capabilities only from its served SC, then the SS MUST verify whether the call request would cause IPC to exceed IPB (or in the case of directionalization if IPCi would exceed IPBi). If the call request would cause the call count to exceed the telephony call count threshold, then the SS MUST do the following:

- In the case of no directionalization, preempt lower precedence telephony call requests and/or telephony calls to free up the necessary resources to support the precedence call request. (See Requirement SIP-005330.b for details on the selection process for preempting lower precedence call requests and calls). The SS MUST notify the NMS whenever the SS performs a network preemption in the context of its Policing function to compel adherence to a telephony call count threshold (see Requirement SIP-005880).⁷⁴
- In the case of directionalization, preempt lower precedence inbound telephony call requests and/or telephony calls to free up the necessary resources to support the precedence call request. (See Requirement SIP-005330.b for details on the selection process for preempting lower precedence call requests and calls). The SS MUST notify the NMS whenever the SS performs a network preemption in the context of its

⁷⁴ If the SS is unable to preempt a call request or call on behalf of a precedence call request, then the SS MUST notify the NMS (see Requirements SIP-005860 and SIP-005870).

Policing function to compel adherence to a telephony call count threshold (see Requirement SIP-005880).⁷⁵

NOTE: The policing of inbound Empty INVITEs is covered in Requirement SIP-005840

7.3.2.2 *Inbound re-INVITE*

SIP-006020 When an SS receives an inbound re-INVITE for a video session for a served SC that is already at or in excess of its configured budget⁷⁶, then the SS MUST forward the re-INVITE to the SC⁷⁷. The inbound re-INVITE is NOT classified as a call request that goes against the video call count threshold (or telephony call count threshold) unless and until a 200 response is received by the SS from the served SC, and then proceeds as follows:

SIP-006020.a In the event the re-INVITE (in Requirement SIP-006020) had a ROUTINE priority level AND the SS receives a 200 response with an sdp answer accepting the video offer from its served SC (that would cause the video count to exceed the threshold), then the SS MUST do the following:

- Send a 488 (Not Acceptable Here) response code to the remote initiating party of the AS-SIP INVITE that MUST include a Warning header field with warning code 370 (Insufficient Bandwidth).
- Send a BYE request to the remote initiating party of the AS-SIP INVITE.
- Send a BYE request to the local SC.
- Notify the NMS whenever a ROUTINE level video session request is rejected to compel adherence to a video count threshold (see Requirements SIP-006030 and SIP-006040).

SIP-006020.b In the event the re-INVITE (in Requirement SIP-006020) had a priority level greater than ROUTINE (i.e., a precedence call) AND the SS receives a 200 response with an sdp answer accepting the video offer from its served SC (that would cause the video count to exceed the threshold), then the SS MUST do the following:

- In the case of no directionalization, preempt lower precedence video session requests and/or video sessions to free up the necessary resources to support the precedence session request. (See Requirement SIP-005330.b for details on the selection process for preempting lower precedence session requests and sessions). The SS MUST notify the NMS whenever the SS performs a network preemption in the context of its

⁷⁵ If the SS is unable to preempt a call request or call on behalf of a precedence call request, then the SS MUST notify the NMS (see Requirements SIP-005860 and SIP-005870).

⁷⁶ For a re-INVITE, in the case of directionalization: if the existing call is a telephony call, then the new video session is applied to the inbound video session count; if the existing call is an outbound video session, then policing occurs when the new video session request uses more VSUs than the current video session and the additional VSUs would exceed VDB_o; if the existing session is an inbound video session then policing occurs when the new video session request uses more VSUs than the current video session and the additional VSUs would exceed VDB_i.

⁷⁷ The SC has primary responsibility for ensuring that the access link is in compliance with the call count threshold.

- Policing function to compel adherence to a video count threshold (see Requirement SIP-006050).⁷⁸
- In the case of directionalization, when the existing call is a telephony call, then preempt lower precedence inbound video session requests and/or video sessions to free up the necessary resources to support the precedence session request. (See Requirement SIP-005330.b for details on the selection process for preempting lower precedence session requests and sessions). The SS MUST notify the NMS whenever the SS performs a network preemption in the context of its Policing function to compel adherence to a video count threshold (see Requirement SIP-006050).⁷⁹
 - In the case of directionalization, when the existing call is an outbound video session, then preempt lower precedence outbound video session requests and/or video sessions to free up the necessary resources to support the precedence session request. (See Requirement SIP-005330.b for details on the selection process for preempting lower precedence session requests and sessions). The SS MUST notify the NMS whenever the SS performs a network preemption in the context of its Policing function to compel adherence to a video count threshold (see Requirement SIP-006050).⁸⁰
 - In the case of directionalization, when the existing call is an inbound video session, then preempt lower precedence inbound video session requests and/or video sessions to free up the necessary resources to support the precedence session request. (See Requirement SIP-005330.b for details on the selection process for preempting lower precedence session requests and sessions). The SS MUST notify the NMS whenever the SS performs a network preemption in the context of its Policing function to compel adherence to a video count threshold (see Requirement SIP-006050).⁸¹

SIP-006020.c In the event the re-INVITE (in Requirement SIP-006020) did not have a Require header or had a Require header but not the option tag “resource-priority” AND the SS does not recognize the network domain or recognizes the network domain but the r priority field does not have a valid value for the given network domain and the SS receives a 200 response having an sdp answer accepting the video offer from the served SC (that would cause the video count to exceed the threshold), then the SS MUST do the following:

- Send a 488 (Not Acceptable Here) response code to the remote initiating party of the re-INVITE that MUST include a Warning header field with warning code 370 (Insufficient Bandwidth).

⁷⁸ If the SS is unable to preempt a call request or call on behalf of a precedence call request, then SS MUST notify the NMS (see Requirements SIP-006030 and SIP-006040).

⁷⁹ If the SS is unable to preempt a call request or call on behalf of a precedence call request, then SS MUST notify the NMS (see Requirements SIP-006030 and SIP-006040).

⁸⁰ If the SS is unable to preempt a call request or call on behalf of a precedence call request, then SS MUST notify the NMS (see Requirements SIP-006030 and SIP-006040).

⁸¹ If the SS is unable to preempt a call request or call on behalf of a precedence call request, then SS MUST notify the NMS (see Requirements SIP-006030 and SIP-006040).

- Send a BYE request to the remote initiating party of the re-INVITE.
- Send a BYE request to the local SC.
- Notify the NMS that a video session request was rejected to compel adherence to a video count threshold (see Requirements SIP-006030 and SIP-006040) and that either an unknown network domain ID or an invalid value for the r priority field was encountered, as the case may be.

SIP-006020.d In the event the re-INVITE (in Requirement SIP-006020) had a Require header with the option tag “resource-priority” AND does not recognize the value of the network domain and the served SC responds with a 200 response having an sdp answer accepting the video offer, then the SS MUST do the following:

- Send a 417 (Unknown Resource-Priority) response code to the remote initiating party.
- Send a BYE request to the remote initiating party of the re-INVITE.
- Send a BYE request to the local SC.
- Notify the NMS that a video session request was rejected in order to compel adherence to a video count threshold (see Requirements SIP-006030 and SIP-006040) and that an unknown network domain ID was encountered.

SIP-006020.e In the event the re-INVITE (in Requirement SIP-006020) had a Require header with the option tag “resource-priority” AND recognizes the network domain but the r priority field does not have a valid value for the given network domain AND the served SC responds with a 200 response having an sdp answer accepting the video offer (that would cause the video count to exceed the threshold), then the SS MUST do the following:

- Send a 488 (Not Acceptable Here) response code to the remote initiating party of the re-INVITE that MUST include a Warning header field with warning code 370 (Insufficient Bandwidth).
- Send a BYE request to the remote initiating party of the re-INVITE.
- Send a BYE request to the local SC.
- Notify the NMS that a video session request was rejected to compel adherence to a video count threshold (see Requirements SIP-006030 and SIP-006040) and that an invalid value for the r-priority field was encountered.

SIP-006020.f In the event the re-INVITE (in Requirement SIP-006020) had a ROUTINE priority level AND the SS receives a 200 response with an sdp answer that accepts audio capabilities only from its served SC, then the SS MUST verify whether the re-INVITE would cause IPC to exceed IPB (or if IPC_i would exceed IPB_i in the case of directionalization). If the re-INVITE would cause the call count to exceed the telephony call count threshold, then the SS MUST do the following:

- Send a 488 (Not Acceptable Here) response code to the remote initiating party of the INVITE that MUST include a Warning header field with warning code 370 (Insufficient Bandwidth).
- Send a BYE request to the remote initiating party of the re-INVITE.
- Send a BYE request to the local SC.
- Notify the NMS whenever a ROUTINE level telephony request is rejected to compel adherence to a telephony count threshold (see Requirements SIP-006030 and SIP-006040).

SIP-006020.g In the event the re-INVITE (in Requirement SIP-006020) had a priority level greater than ROUTINE (i.e., a precedence call) AND the SS receives a 200 response with an sdp answer that accepts audio capabilities only from its served SC, then the SS MUST verify whether the re-INVITE would cause IPC to exceed IPB (or if IPCi would exceed IPBi in the case of directionalization). If the re-INVITE would cause the call count to exceed the telephony call count threshold, then the SS MUST do the following:

- In the case of no directionalization, preempt lower precedence telephony call requests and/or telephony calls to free up the necessary resources to support the precedence call request. (See Requirement SIP-005330.b for details on the selection process for preempting lower precedence call requests and calls). The SS MUST notify the NMS whenever the SS performs a network preemption in the context of its Policing function to compel adherence to a telephony call count threshold (see Requirement SIP-005880).⁸²
- In the case of directionalization, preempt lower precedence inbound telephony call requests and/or telephony calls to free up the necessary resources to support the precedence call request. (See Requirement SIP-005330.b for details on the selection process for preempting lower precedence call requests and calls). The SS MUST notify the NMS whenever the SS performs a network preemption in the context of its Policing function to compel adherence to a telephony call count threshold (see Requirement SIP-005880).⁸³

7.3.3 Notification to the NMS

SIP-006030 The SS MUST notify the NMS whenever a ROUTINE or precedence video session request is rejected to compel adherence to a video count threshold pursuant to the Policing

⁸² If the SS is unable to preempt a call request or call on behalf of a precedence call request, then the SS MUST notify the NMS (see Requirements SIP-005860 and SIP-005870).

⁸³ If the SS is unable to preempt a call request or call on behalf of a precedence call request, then the SS MUST notify the NMS (see Requirements 005860 and SIP-005870).

function, or whenever a video session request or video session is preempted pursuant to the Policing function.⁸⁴

SIP-006040 The notification to the NMS regarding the rejection of a video session request pursuant to SS Policing function **MUST** include the following:

- The date and time of the rejection of the video session request.
- The calling party number and called party number of the rejected session request.
- The precedence level of the rejected session request.
- The identity of the AS-SIP signaling appliance where the video count threshold is being protected.
- The direction of the session request (inbound or outbound).

SIP-006050 The notification to the NMS regarding the preemption of a video session request or video session pursuant to the SS Policing function **MUST** include the following:

- The date and time of receipt of the precedence session request.
- The calling party number and called party number of the precedence session request.
- The precedence level of the precedence session request.
- The date and time of the preemption of the video session request or session.
- The calling party number and called party number of the preempted session request or call.
- The precedence level of the preempted session request or session.
- The identity of the AS-SIP signaling appliance where the video count threshold is being protected.
- The direction of the session request (inbound or outbound).

7.3.4 Operational Adjustments

SIP-006060 Although outside the scope of this specification, the video count threshold at the SS **MAY** be set to a value slightly above the mandated video count threshold for the corresponding AS-SIP signaling appliance. This procedure creates a safety margin for avoidance of call rejection or preemption due to the possibility of transient race conditions.

⁸⁴ The network management requirements will dictate the nature of the notification (e.g., SNMP trap or alarm) and the specific format of the notification.

SECTION 8 VIDEO TELEPHONY – GENERAL RULES

8.1 CALLER

SIP-006070 Video telephony EIs MUST, as the default configuration, require an end user wishing to place a call that includes video, to affirmatively signal the intention to include video to the EI every time the caller wishes to engage in a video telephony call. The interactive mechanism by which the caller signals this intention to include video is left to the vendors.⁸⁵

SIP-006070.a When the caller affirmatively signals an intention to make a video telephony call and the initial INVITE includes an sdp offering audio and video capabilities and the initial sdp answer accepts both audio and video capabilities, then the caller is not required to signal his or her intention again to the EI to conduct a video telephony call upon receipt of the sdp answer.

SIP-006070.b When the caller affirmatively signals an intention to make a video telephony call and the initial INVITE includes an sdp offering audio and video capabilities and the initial sdp answer accepts audio but not video capabilities, then the call will take the form of an audio call and for the caller to attempt to convert the audio call to a video telephony call, the caller MUST again affirmatively signal to the EI an intention to include video. Then a re-INVITE with an sdp offering audio and video capabilities will be sent to the destination EI.

SIP-006070.c When the caller affirmatively signals an intention to make a video telephony call and the initial INVITE does not include an sdp offer (Empty INVITE), then if the initial sdp offer received from the called party includes both audio and video capabilities, the caller's EI can accept the audio and video capabilities without prompting the caller to again affirmatively signal an intention to conduct a video telephony call.⁸⁶

SIP-006070.d When the caller affirmatively signals an intention to make a video telephony call and the initial INVITE does not include an sdp offer (Empty INVITE), then if the sdp offer received from the called party includes only audio capabilities but not video capabilities, then the calling EI accepts the audio capabilities, and for the caller to convert the audio call to a video telephony call, the caller MUST again affirmatively signal to the EI the intention to include video. Then a re-INVITE with an sdp offering audio and video capabilities will be sent to the destination EI.

SIP-006080 Every time a caller requests a video telephony call and the video portion of the telephony call is successfully established, then the video telephony EI MUST provide the user

⁸⁵ Examples include pressing a physical button or switch, clicking on a virtual soft button, or selecting the video telephony option from a display menu when entering either the dial string or selecting the intended recipient from an electronic address book.

⁸⁶ The caller has just affirmatively indicated an intention to engage in a video telephony call before the transmission of the Empty INVITE.

with an affirmative confirmation that the video is enabled either before, or upon successful completion of, session establishment. The affirmative confirmation **MUST** take the form of both an audio and a visual signal to the caller.

NOTE: The intent of this requirement is to ensure that the caller is fully aware that video is being transmitted.

8.2 CALLEE

SIP-006090 When an INVITE with an sdp offer that includes both audio and video capabilities is received by an SC serving a destination EI that supports video telephony, then when the call request is received by the destination EI the destination EI **MUST** indicate to the callee that a telephony call requesting video connectivity has been received. As the default configuration, the callee **MUST** affirmatively signal to the EI a desire to accept a video telephony call (as opposed to an audio call) in order for the EI to accept a video request and for the destination SC to respond with an sdp answer that includes video capabilities in addition to audio capabilities.

SIP-006090.a 1 If the callee initially accepts an audio call, then the callee **MUST** affirmatively signal to the EI a desire to add video to the call if the callee wishes to convert the audio call into a video telephony call. Then a re-INVITE **MUST** be sent to the originating SC/EI offering both audio and video capabilities.

SIP-006090.a.1 Upon receipt of the re-INVITE from the callee offering audio and video capabilities, the calling IP EI **MUST** notify the caller that there has been a request to upgrade the existing call to a video telephony call, and the caller **MUST** affirmatively signal to the EI a desire to accept the upgrade of the call to video telephony in order for the calling party's EI to accept the audio and video capabilities.

SIP-006090.b If the callee affirmatively signals to the EI a desire to accept the video component of the call only after the transmission of an sdp answer accepting only audio capabilities, then a re-INVITE **MUST** be sent to the originating SC/EI offering both audio and video capabilities.

SIP-006090.b.1 Upon receipt of the re-INVITE from the callee offering audio and video capabilities, the calling IP EI **MUST** notify the caller that there has been a request to upgrade the existing call to a video telephony call, and the caller **MUST** affirmatively signal to the EI a desire to accept the upgrade of the call to video telephony in order for the calling party's EI to accept the audio and video capabilities.

SIP-006100 When an SC serving a destination IP EI receives an INVITE lacking an sdp offer (Empty INVITE) and the destination EI supports video telephony, then the destination EI **MAY** offer the callee the option to affirmatively signal to the EI a desire to select a video telephony call.

SIP-006100.a If the callee affirmatively signals to the EI a desire to select a video telephony call after the transmission of a response with an sdp offer having audio capabilities only, then the SC (or the SIP EI) MUST wait until the initial INVITE has completed, and then send a re-INVITE to the originating SC/EI offering both audio and video capabilities.

SIP-006100.a.1 Upon receipt of the re-INVITE from the callee offering audio and video capabilities, the calling IP EI MUST notify the caller that there has been a request to upgrade the existing call to a video telephony call, and the caller MUST affirmatively signal to the EI a desire to accept the upgrade of the call to video telephony in order for the calling party's EI to accept the audio and video capabilities.

SIP-006110 Every time a callee accepts a video telephony call and the video portion of the telephony call is successfully established, then the video telephony EI MUST provide the user with an affirmative confirmation that the video is enabled either before or upon successful session establishment. The affirmative confirmation MUST take the form of both an audio and a visual signal to the callee.

NOTE: The intent of this requirement is to ensure that the callee is fully aware that video is being transmitted.

8.3 IP-TO-IP VIDEO TELEPHONY CALL FLOWS

This section furnishes a representative set of two-party video telephony call flows where the originating EI is IP and located at one base, the terminating EI is IP and located at another base, and AS-SIP signaling is used over the UC WAN to conduct call setup, maintenance, and termination.

[Section 8.3.1](#), INVITE With sdp Video Offer Accepted in 200 Response With sdp Answer, and [Section 8.3.2](#), INVITE With sdp Video Offer – Called Party Accepts Video After 200 Response, detail call flows in which the INVITE includes an sdp offer of audio and video capabilities.

[Section 8.3.3](#), Empty INVITE – Caller Requests Video; Called Party Offers Video (Media Feature Tags NOT Used), and [Section 8.3.4](#), Empty INVITE – Caller Requests Video; Called Party Offers Audio; Caller Again Requests Video (Media Feature Tags NOT Used), detail call flows in which the INVITE does not include an sdp offer (Empty INVITE) and where the originating SC and terminating SC do not add or process audio and video media feature tags that may be located in the Contact header of the INVITE.

[Section 8.3.5](#), Empty INVITE – Caller Requests Video; Called Party Offers Video (Media Feature Tags Used by Originating SC and Terminating SC), and [Section 8.3.6](#), Empty INVITE – Caller Requests Video; Called Party Offers Audio – Calling Party Again Requests Video (Media Feature Tags Used by Originating SC and Terminating SC), detail call flows in which the INVITE does not include an sdp offer (Empty INVITE) and where the originating SC adds the

audio and video media feature tags and the terminating SC processes the audio and video media feature tags.

NOTE: The call flows in [Figure 8.3-1](#), INVITE With sdp Video Offer Accepted in 200 Response With sdp Answer, and [Figure 8.3-3](#), INVITE With sdp Video Offer – Called Party Accepts Video After 200 Response, and the call flows in [Figure 8.3-2](#), INVITE With sdp Video Offer Accepted in 200 Response With sdp Answer (AS-SIP EI), and [Figure 8.3-4](#), INVITE With sdp Offer – Called Party Accepts Video After 200 Response (AS-SIP EI), are identical except for the sequence of the ASAC call count events conducted by the SCs.

NOTE: The AS-SIP EIs are not required to be capable of generating media feature tags or to be capable of processing received media feature tags; however, an AS-SIP EI that receives but does not understand media feature tags **MUST** ignore them and **MUST NOT** reject the call solely because of the presence of a media feature tag in the Contact header.

In the case of IP-to-IP calls when the INVITE includes an sdp offer, then the sdp answer is provided in the 200 response, and when the INVITE does not have an sdp offer (Empty INVITE), the sdp offer is made in the 200 response and the sdp answer is made in the ACK request. [Section 16](#), Supplementary Services, details the IP-TDM call flows where an INVITE with an sdp offer receives an sdp answer in the first non-failure, reliable provisional response, and an INVITE that does not have an sdp offer (Empty INVITE) receives an sdp offer in the first non-failure, reliable provisional response and the sdp answer is transmitted in the PRACK message. These rules enable the originating SC to identify whether the recipient EI is served by the UC IP network or the DSN TDM network, and therefore, alert the originating SC either to arrange for the EI to play tones and announcements locally or to instruct the EI to listen for early media instead.

NOTE: The video telephony call flows use the re-INVITE method (NOT the UPDATE method) to escalate the audio telephony call to a video telephony call. The UPDATE method is NOT an appropriate request method for conducting escalation of a call from audio telephony to video telephony and **MUST NOT** be used for this purpose. A successful escalation of a call from audio telephony to video telephony requires an affirmative user response (i.e., user approval) on the part of the recipient of the escalation request. This is consistent with the use of the re-INVITE but **NOT** consistent with the use of the UPDATE. Quoting from RFC 3311, The SIP Update Method, Section 5.1. “Although UPDATE can be used on confirmed dialogs, it is **RECOMMENDED** that a re-INVITE be used instead. This is because an UPDATE needs to be answered immediately, ruling out the possibility of user approval. Such approval will frequently be needed, and is possible with a re-INVITE.”

In particular, the telephony call flows to which this note applies are as follows:

STEP	INSTRUCTION
1, 2, 3	Party A affirmatively signals to its EI a desire to initiate a video telephony call.
	<p>Upon receiving an initial call request message from IP Party A (not depicted in Figure 8.3-1), the SC serving IP Party A either generates and sends an INVITE with an sdp offering audio and video capabilities to SS A or forwards an INVITE with an sdp offering audio and video capabilities (created by SIP EI A) to SS A. SS A forwards the INVITE across the WAN to SS B (which is assigned to the SC serving IP Party B). SS B forwards the INVITE to the SC serving IP Party B.</p> <p>When the SC serving IP Party B sends the INVITE or other call request message to the EI serving IP Party B, then Party B is notified by the called EI that a video telephone call has been requested so that Party B has the opportunity to indicate affirmatively to the EI a desire to accept a video call.</p> <p>NOTE: Signaling between the EI serving IP Party A and the SC serving IP Party A is not depicted. NOTE: Signaling between the SC serving IP Party B and the EI serving IP Party B is not depicted. ASAC</p> <p>Before sending 1, SC A increments video count.</p> <p>Upon receiving 1, SS A increments video count.</p> <p>Upon receiving 3, SC B increments video count.</p>
4, 5, 6	Assuming the EI is not busy, the SC serving IP Party B sends a 180 (Ringing) to SS B. It forwards the 180 (Ringing) to SS A, which forwards the 180 (Ringing) to the SC serving IP Party A.
	<p>NOTE: Signaling between the EI serving IP Party B and the SC serving IP Party B is not depicted. NOTE: Signaling between the SC serving IP Party A and the EI serving IP Party A is not depicted. ASAC</p> <p>Upon receiving 4, SS B increments video count</p>
7, 8, 9	Party B affirmatively signals to its EI an intention to accept a video telephone call.
	<p>When IP Party B goes off hook (i.e., answers the call), the SC serving IP Party B sends a 200 (OK) response with an sdp answer accepting audio and video capabilities to SS B. SS B forwards the 200 (OK) response to SS A, which forwards the 200 (OK) response to the SC serving IP Party A.</p> <p>EI B notifies Party B that a video call has been established.</p> <p>NOTE: Signaling between the EI serving IP Party B and the SC serving IP Party B is not depicted. In addition, signaling between the SC serving IP Party A and the EI serving IP Party A is not depicted.</p>
Result:	EI A notifies Party A that a video call has been established.
10, 11, 12	The SC serving IP Party A sends an ACK to SS A. It forwards the ACK to SS B, which forwards the ACK to the SC serving IP Party B.
	NOTE: Signaling between the EI serving IP Party A and the SC serving IP Party A is not depicted. In addition, signaling between the SC serving IP Party B and the EI serving IP Party B is not depicted.

8.3.1.1 INVITE With sdp Video Offer Accepted in 200 Response With sdp Answer (AS-SIP EI)

When the IP EIs are AS-SIP EIs, then the AS-SIP messaging is exchanged end-to-end by the AS-SIP EIs. The AS-SIP EIs generate and process the sdp bodies. [Figure 8.3-2](#) shows AS-SIP EI A sending an INVITE with an sdp video offer (Step 1). AS-SIP EI B receives the INVITE (Step

5), responds with a 180 (Ringing) response (Step 6), and notifies the user of the request for a video telephone call. AS-SIP EI A receives the 180 (Ringing) response (Step 10). The user at AS-SIP EI B accepts the video request to AS-SIP EI and goes off-hook. AS-SIP EI B sends a 200 (OK) response with an sdp answer accepting the video call (Step 11), and confirms the video call to the user. AS-SIP EI A receives the 200 (OK) response (Step 15), notifies the user that the video call has been accepted, and sends an ACK (Step 16). AS-SIP EI B receives the ACK (Step 20).

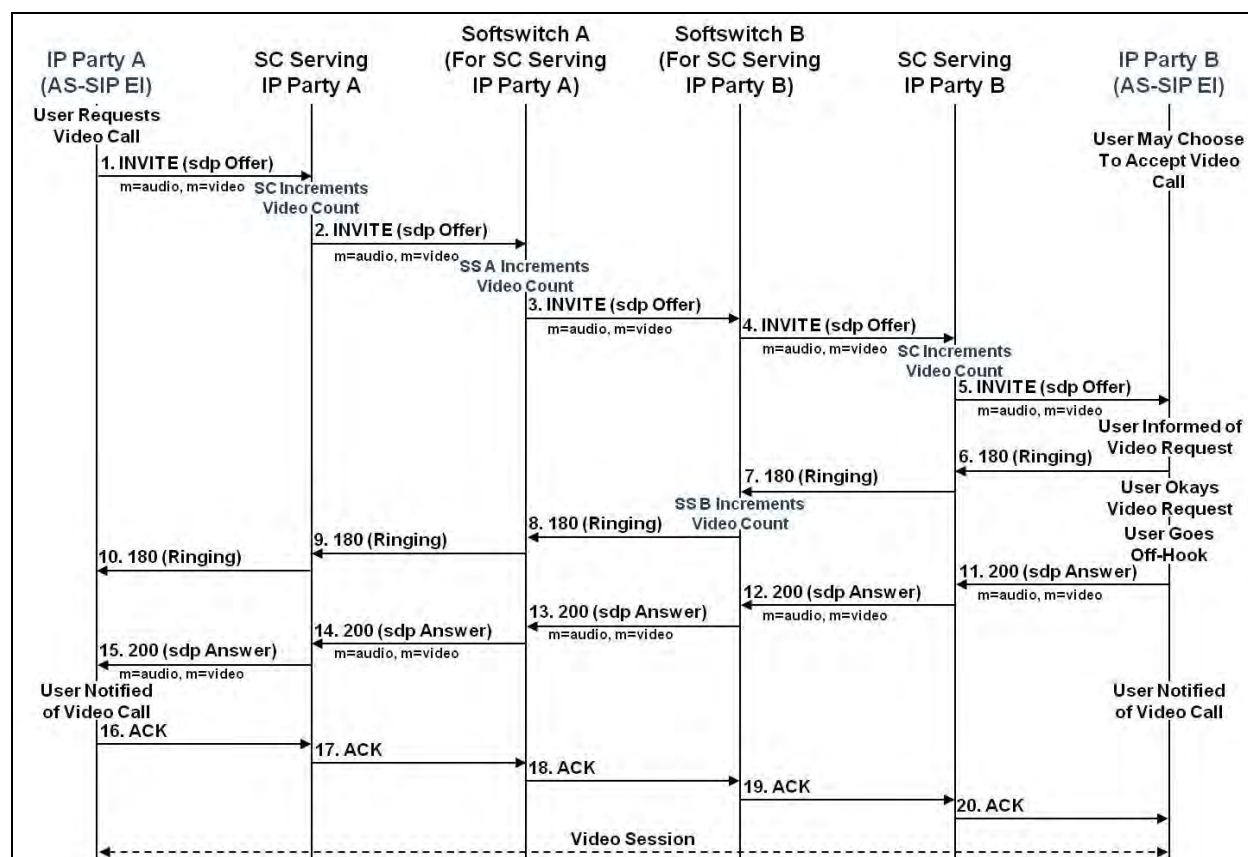

Figure 8.3-2. INVITE With sdp Video Offer Accepted in 200 Response With sdp Answer (AS-SIP EI)

8.3.2 INVITE With sdp Video Offer – Called Party Accepts Video After 200 Response

Party A affirmatively signals its EI an intention to request a video telephony call. This is reflected in the INVITE that includes an sdp offer of audio and video capabilities, shown in [Figure 8.3-3](#), INVITE With sdp Video Offer – Called Party Accepts Video After 200 Response. Party B is apprised of the video telephony call request and does not signal its EI to accept the video telephony offer until after the 200 response is sent. Party B’s EI sends a re-INVITE (or equivalent) offering audio and video capabilities pursuant to Party B’s affirmative signal to engage in a video call. Upon receipt of the INVITE with the sdp offer, Party A’s EI notifies Party A of the offer to add video to the call. Party A affirmatively signals a desire to add video. An

ACK with an sdp answer accepting audio and video capabilities is sent back to the SC serving IP Party B.

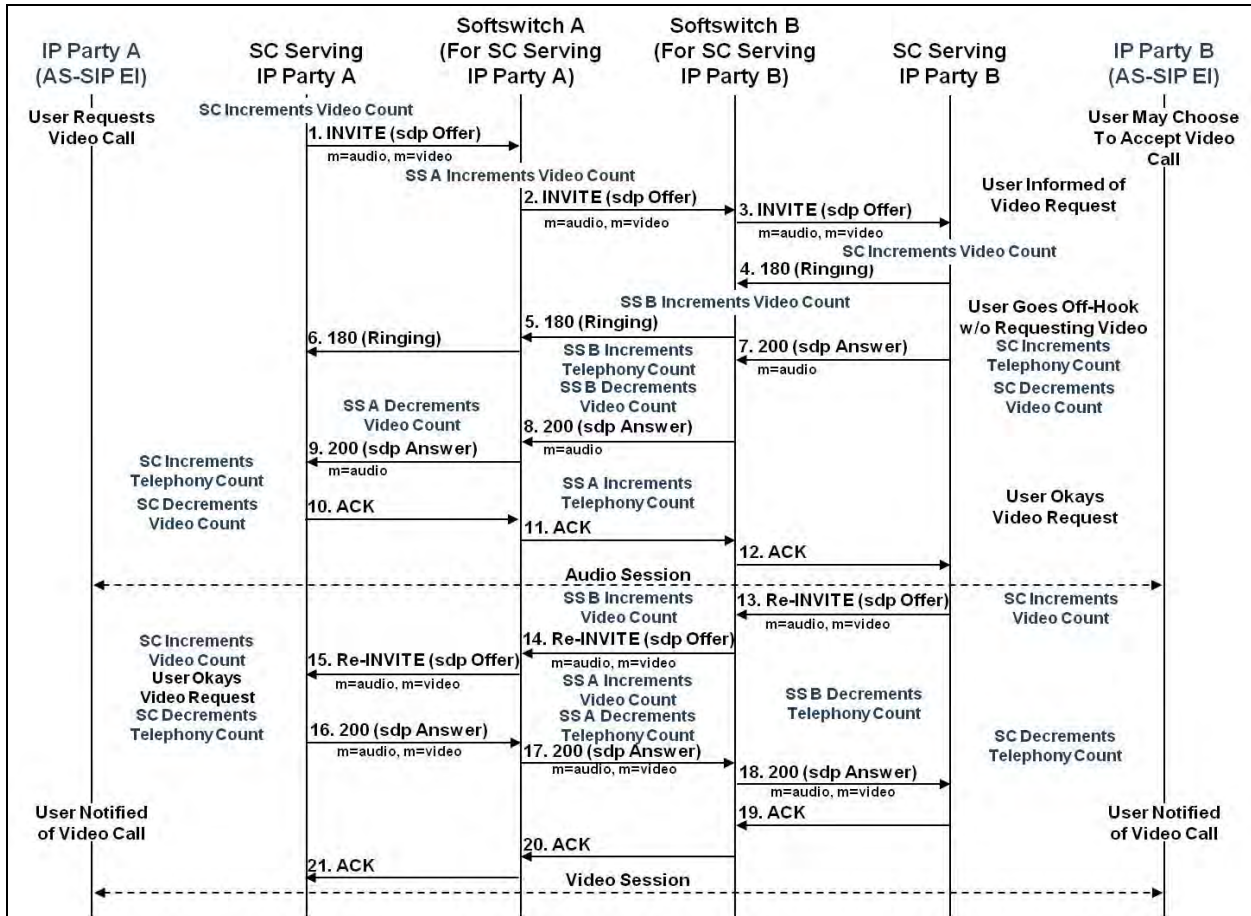

Figure 8.3-3. INVITE With sdp Video Offer – Called Party Accepts Video After 200 Response

STEP	INSTRUCTION
1, 2, 3	Party A affirmatively signals to EI a desire to initiate a video telephony call.
	Upon receiving an initial call request message from IP Party A (not depicted in the call flow diagram), the SC serving IP Party A either generates and sends an INVITE with an sdp offering audio and video capabilities to SS A or forwards an INVITE with an sdp offering audio and video capabilities (created by SIP EI A) to SS A. SS A forwards the INVITE across the WAN to SS B (which is assigned to the SC serving IP Party B). SS B forwards the INVITE to the SC serving IP Party B.
	When SC serving IP Party B sends an INVITE or other call request message to the EI serving IP Party B, then Party B is notified by the called EI that a video telephone call has been requested so Party B has the opportunity to affirmatively indicate to the EI a desire to accept a video call.
	NOTE: Signaling between the EI serving IP Party A and the SC serving IP Party A is not depicted. In addition, signaling between the SC serving IP Party B and the EI serving IP Party B is not depicted. However, it should be noted that

ASAC

Before sending 1, SC A increments video count.

Upon receiving 1, SS A increments video count.

Upon receiving 3, SC B increments video count.

STEP	INSTRUCTION
4, 5, 6	Assuming the EI is not busy, the SC serving IP Party B sends a 180 (Ringing) response to SS B. It forwards the 180 (Ringing) response to SS A, which forwards the 180 (Ringing) response to the SC serving IP Party A.
	NOTE: Signaling between the EI serving IP Party B and the SC serving IP Party B is not depicted. In addition, signaling between the SC serving IP Party A and the EI serving IP Party A is not depicted.

ASAC

Upon receiving 4, SS B increments video count.

STEP	INSTRUCTION
7, 8, 9	Party B does NOT affirmatively signal to its EI a desire to accept a video telephone call.
	When IP Party B goes off-hook (i.e., answers the call), the SC serving IP Party B sends a 200 (OK) response with an sdp answer accepting audio capabilities to SS B. SS B forwards the 200 (OK) response to SS A, which forwards the 200 (OK) response to the SC serving IP Party A.
	NOTE: Signaling between the EI serving IP Party B and the SC serving IP Party B is not depicted. In addition, signaling between the SC serving IP Party A and the EI serving IP Party A is not depicted.

ASAC

Before sending 7, SC B increments telephony count and decrements video count.

Upon receiving 7, SS B increments telephony count and decrements video count.

Upon receiving 8, SS A decrements video count.

Upon receiving 9, SC A increments telephony count.

STEP	INSTRUCTION
10, 11, 12	The SC serving IP Party A sends an ACK to SS A. It forwards the ACK to SS B, which forwards the ACK to the SC serving IP Party B.
	NOTE: Signaling between the EI serving IP Party A and the SC serving IP Party A is not depicted. In addition, signaling between the SC serving IP Party B and the EI serving IP Party B is not depicted.

ASAC

Before sending 10, SC A decrements video count.

Upon receiving 10, SS A increments telephony count.

STEP	INSTRUCTION
13, 14, 15	Party B affirmatively signals to its EI a desire to add video to the existing call.
	Upon receiving a call request/change message (re-INVITE in the case of a SIP EI) (not depicted in the call flow diagram), the SC serving IP Party B either generates and sends a re-INVITE with an sdp offering audio and video capabilities to SS B, or forwards a re-INVITE with an sdp offering audio and video capabilities (created by SIP EI B) to SS B. SS B forwards the re-INVITE across the WAN to SS A (which is assigned to the SC serving IP Party A). SS A forwards the INVITE to the SC serving IP Party A.
	When the SC serving IP Party A sends the re-INVITE or equivalent call request message to the EI serving IP Party A, then Party A is notified by the EI that Party A is being requested to turn the existing call into a video telephony call.
	NOTE: Signaling between the EI serving IP Party B and the SC serving IP Party B is not depicted. In addition, signaling between the SC serving IP Party A and the EI serving IP Party A is not depicted.

ASAC

Before sending 13, SC B increments video count.

Upon receiving 13, SS B increments video count.

Upon receiving 15, SC A increments video count.

STEP	INSTRUCTION
16, 17, 18	Party A affirmatively signals its EI of Party A's intention to convert the call to a video telephony call.
	Upon receiving a positive response from Party A's EI, the SC serving IP Party A either generates and sends a 200 (OK) response with an sdp answer accepting audio and video capabilities to SS A or forwards a 200 (OK) response with an sdp answer accepting audio and video capabilities (created by SIP EI A) to SS A. SS A forwards the 200 (OK) response across the WAN to SS B. SS B forwards the 200 (OK) response to the SC serving IP Party B.
	EI A notifies Party A that a video call has been established.
	NOTE: Signaling between the EI serving IP Party A and the SC serving IP Party A is not depicted. In addition, signaling between the SC serving IP Party B and the EI serving IP Party B is not depicted.

ASAC

Before sending 16, SC A decrements telephony count.

Upon receiving 16, SS A increments video count and decrements telephony count.

Upon receiving 17, SS B decrements telephony count.

Upon receiving 18, SC B decrements telephony count.

STEP	INSTRUCTION
19, 20, 21	EI B notifies Party B that a video call has been established.
	The SC serving IP Party B sends an ACK to SS B. It forwards the ACK to SS A, which forwards the ACK to the SC serving IP Party A.
	NOTE: Signaling between the EI serving IP Party B and the SC serving IP Party B is not depicted. In addition, signaling between the SC serving IP Party A and the EI serving IP Party A is not depicted.

8.3.2.1 INVITE With sdp Video Offer – Called Party Accepts Video After 200 Response (AS-SIP EI)

[Figure 8.3-4](#), INVITE With sdp Offer – Called Party Accepts Video After 200 Response (AS-SIP EI), shows AS-SIP EI A sending an INVITE with an sdp video offer (Step 1). AS-SIP EI B receives the INVITE (Step 5), responds with 180 (Ringing) response (Step 6), and notifies the user of the request for a video telephone call. AS-SIP EI A receives a 180 (Ringing) response (Step 10). The user at AS-SIP EI B does not accept the video request before going off-hook. AS-SIP EI B sends a 200 (OK) response with an sdp answer accepting the telephony call (Step 11). AS-SIP EI A receives a 200 (OK) response and sends an ACK (Step 16). AS-SIP EI B receives an ACK (Step 20). AS-SIP EI B sends a re-INVITE offering video session in sdp (Step 21). AS-SIP EI A receives a re-INVITE (Step 25), and notifies the user of the video request. The user indicates acceptance of the video request to AS-SIP EI A. AS-SIP EI A sends a 200 (OK) response with an sdp answer accepting the video session (Step 26) and notifies the user of the successful video call. AS-SIP EI B receives a 200 (OK) response (Step 30), responds with an ACK (Step 31), and notifies the user of the accepted video call. AS-SIP EI A receives the ACK (Step 35).

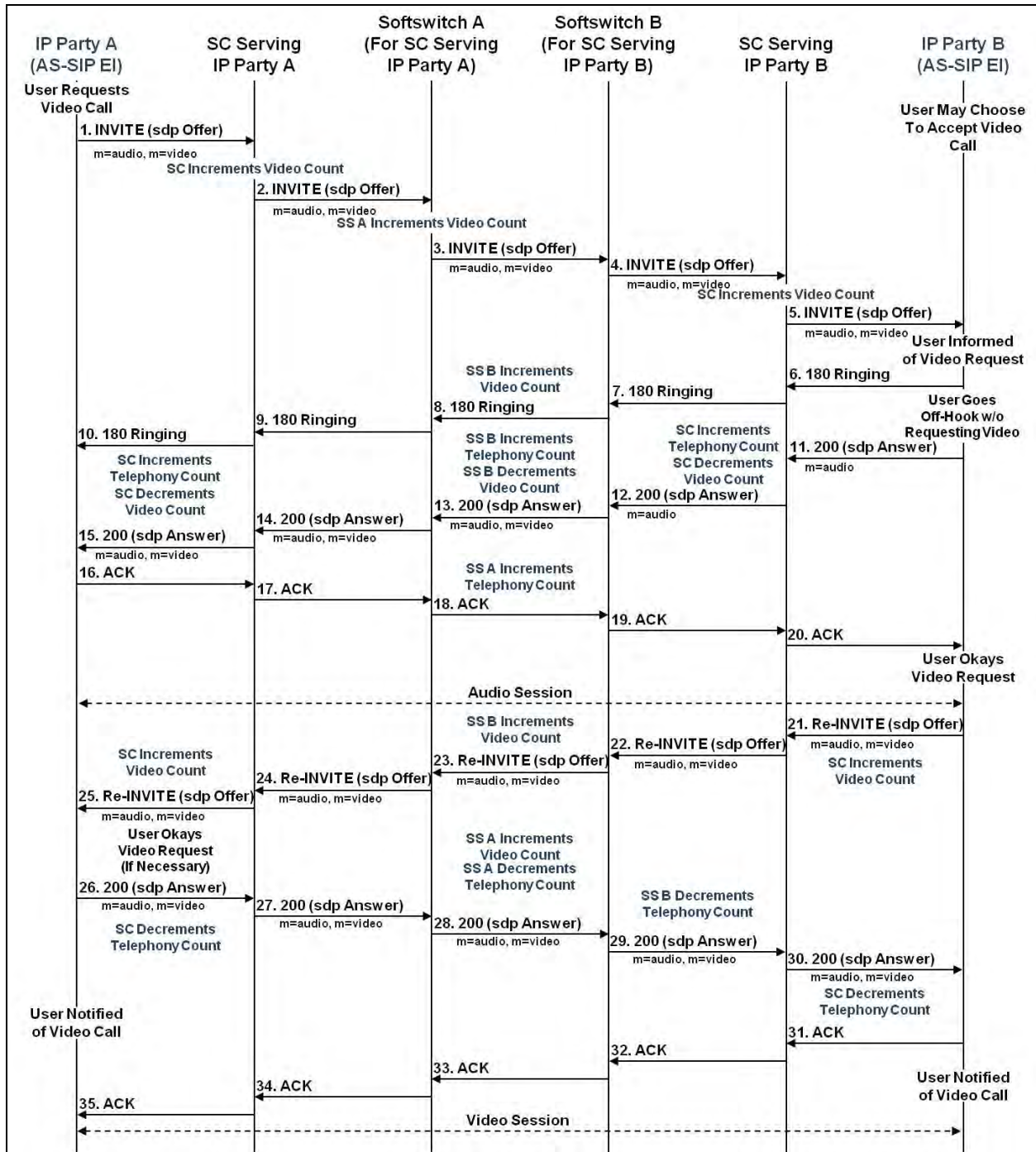

Figure 8.3-4. INVITE With sdp Offer – Called Party Accepts Video After 200 Response (AS-SIP EI)

8.3.3 Empty INVITE – Caller Requests Video; Called Party Offers Video (Media Feature Tags NOT Used)

Party A affirmatively signals to its EI an intention to request a video telephony call. An Empty INVITE, shown in [Figure 8.3-5](#), is sent to the SC serving IP Party B. When Party B’s EI receives

the Empty INVITE (or equivalent call request) Party B's EI MAY offer Party B the option of requesting a video telephony call. Party B affirmatively signals its EI of its intention to offer a video telephony call and the 200 (OK) response includes an sdp offer that includes audio and video capabilities. Party A's EI accepts the audio and video capabilities and an ACK with an sdp answer having audio and video capabilities is sent back over the UC WAN to IP Party B.

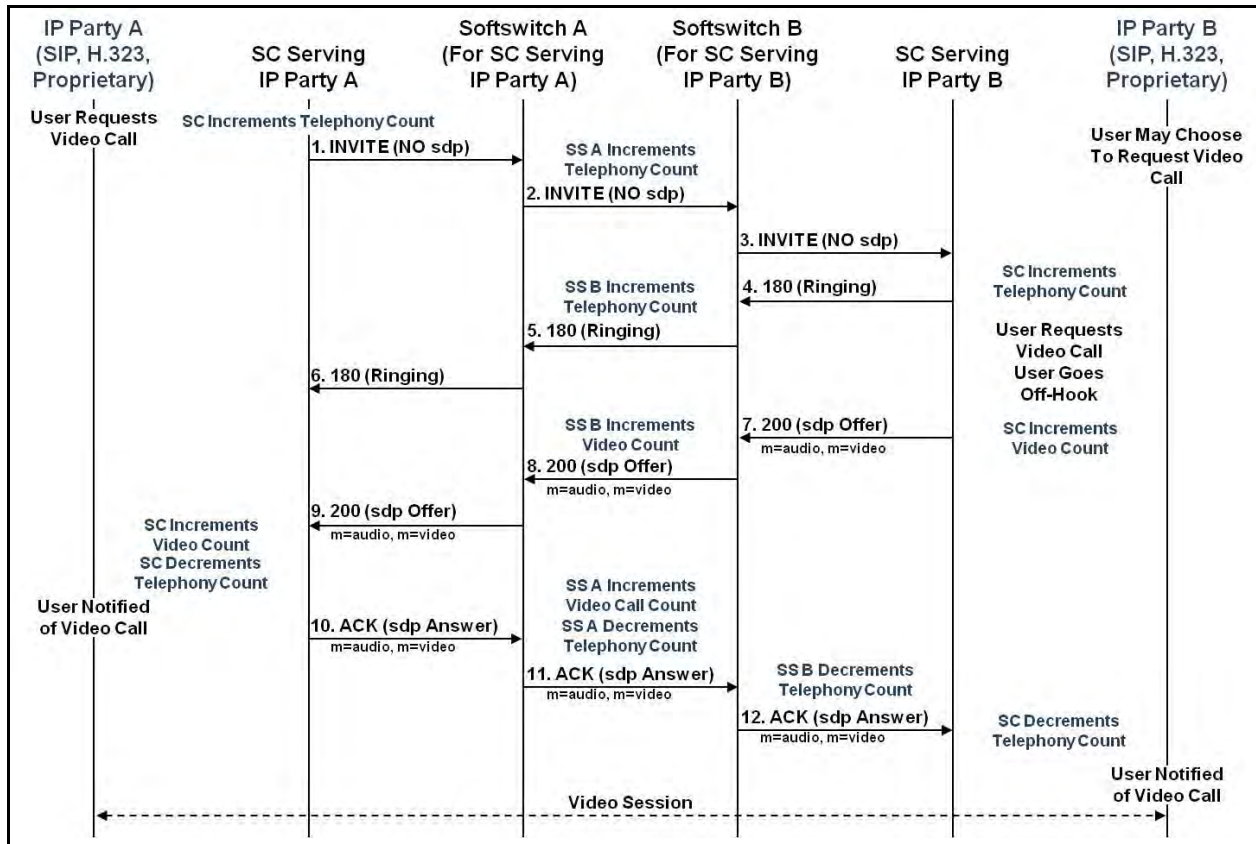

Figure 8.3-5. Empty INVITE – Caller Requests Video; Called Party Offers Video (Media Feature Tags NOT Used)

STEP	INSTRUCTION
1, 2, 3	Party A affirmatively signals to its EI an intention to initiate a video telephony call.
	Upon receiving an initial call request message from IP Party A (not depicted in the call flow diagram), the SC serving IP Party A either generates and sends an Empty INVITE to SS A or forwards an Empty INVITE (created by SIP EI A) to SS A. SS A forwards the Empty INVITE across the WAN to SS B (which is assigned to the SC serving IP Party B). SS B forwards the Empty INVITE to the SC serving IP Party B.
	When the SC serving IP Party B sends an Empty INVITE or other call request message to the IP EI serving Party B, then the EI MAY apprise Party B of the option of requesting a video call.
	NOTE: Signaling between the EI serving IP Party A and the SC serving IP Party A is not depicted. In addition, signaling between the SC serving IP Party B and the EI serving IP Party B is not depicted.

ASAC

Before sending 1, SC A increments telephony count.

Upon receiving 1, SS A increments telephony count.

Upon receiving 3, SC B increments telephony count.

STEP	INSTRUCTION
4, 5, 6	Assuming the EI is not busy, the SC serving IP Party B sends a 180 (Ringing) response to SS B. It forwards the 180 (Ringing) to response SS A, which forwards the 180 (Ringing) response to the SC serving IP Party A.
	NOTE: Signaling between the EI serving IP Party B and the SC serving IP Party B is not depicted. In addition, signaling between the SC serving IP Party A and the EI serving IP Party A is not depicted.

ASAC

Upon receiving 4, SS B increments telephony count.

STEP	INSTRUCTION
7, 8, 9	Party B affirmatively signals to its EI an intention to engage in a video telephone call.
	When IP Party B goes off-hook (i.e., answers the call), the SC serving IP Party B sends a 200 (OK) response with an sdp offer of audio and video capabilities to SS B. SS B forwards the 200 (OK) response to SS A, which forwards the 200 (OK) response to the SC serving IP Party A.
	NOTE: Signaling between the EI serving IP Party B and the SC serving IP Party B is not depicted. In addition, signaling between the SC serving IP Party A and the EI serving IP Party A is not depicted.

ASAC

Before sending 7, SC B increments video count.

Upon receiving 7, SS B increments video count.

Upon receiving 9, SC A increments video count.

STEP	INSTRUCTION
10, 11, 12	Since the caller had affirmatively signaled to the EI a desire to engage in a video telephone call and the initial offer from the remote side is a video telephone offer, then the EI will accept the video telephone offer.

EI A notifies Party A that a video call has been established.

The SC serving IP Party A sends an ACK with an sdp answer accepting audio and video capabilities to SS A. It forwards the ACK to SS B, which forwards the ACK to the SC serving IP Party B.

EI B notifies Party B that a video call has been established.

NOTE: Signaling between the EI serving IP Party A and the SC serving IP Party A is not depicted. In addition, signaling between the SC serving IP Party B and the EI serving IP Party B is not depicted.

ASAC

Before sending 10, SC A decrements telephony count.

Upon receiving 10, SS A increments video count and decrements telephony count.

Upon receiving 11, SS B decrements telephony count.

Upon receiving 12, SC B decrements telephony count.

8.3.3.1 Empty INVITE – Caller Requests Video; Called Party Offers Video (Media Feature Tags NOT Used) – AS-SIP EI Receives Empty INVITE

The AS-SIP EIs do NOT generate initial Empty INVITES but they MUST accept Empty INVITES.

[Figure 8.3-6](#), Empty INVITE – Caller Requests Video; Called Party Offers Video (Media Feature Tags NOT Used) – AS-SIP EI Receives Empty INVITE, shows that AS-SIP EI B receives the Empty INVITE (Step 4) and responds with a 180 (Ringing) response (Step 5). User B requests that AS-SIP EI B engage in a video telephone call. User B goes off-hook and AS-SIP EI B sends a 200 (OK) response with an sdp offer for a video session (Step 9). AS-SIP EI B receives the ACK with an sdp answer accepting the video session (Step 16) and notifies the user that the video call is established.

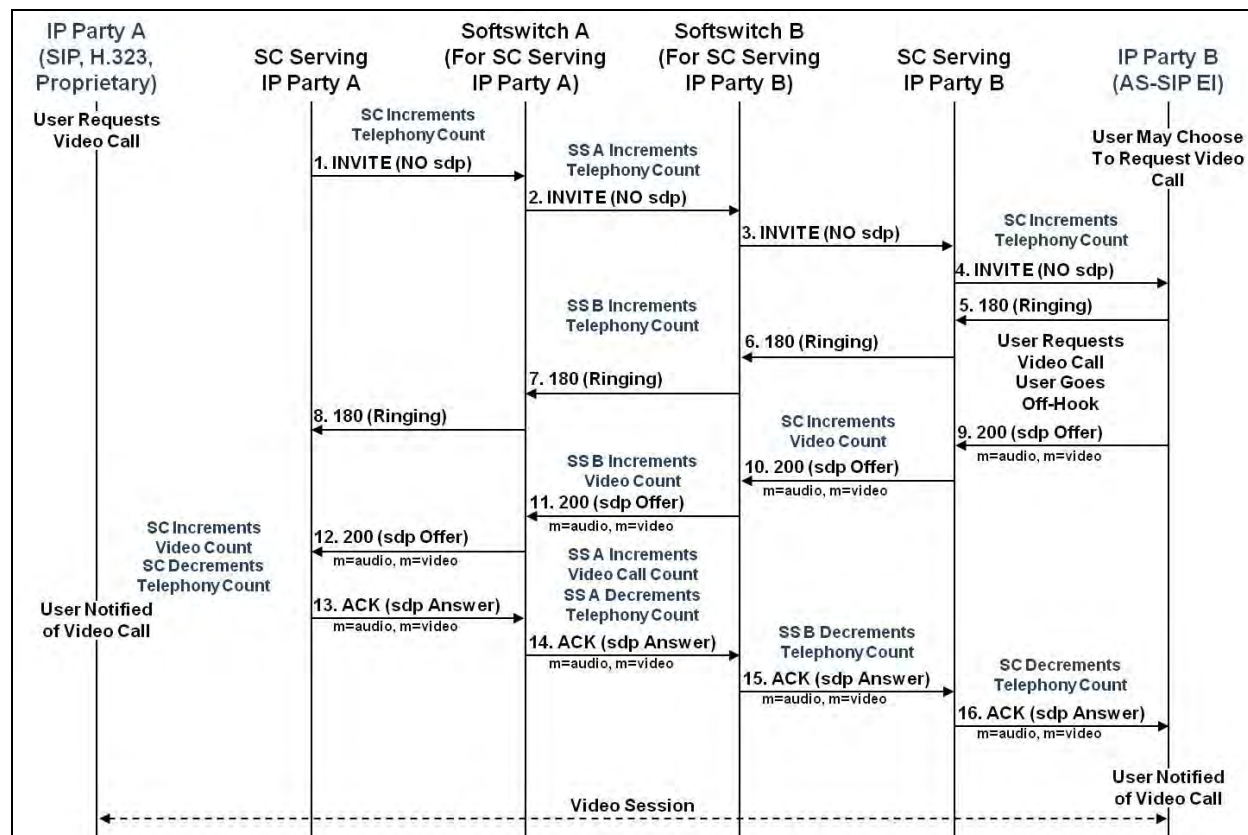

Figure 8.3-6. Empty INVITE – Caller Requests Video; Called Party Offers Video (Media Feature Tags NOT Used) – AS-SIP EI Receives Empty INVITE

8.3.4 Empty INVITE – Caller Requests Video; Called Party Offers Audio; Caller Again Requests Video (Media Feature Tags NOT Used)

Party A affirmatively signals to its EI an intention to request a video telephony call. An Empty INVITE is sent to the SC serving IP Party B. When Party B’s EI receives the Empty INVITE (or equivalent call request) Party B’s EI MAY offer Party B the option of requesting a video telephony call. This is illustrated in [Figure 8.3-7](#), Empty INVITE – Caller Requests Video; Called Party Offers Audio; Caller Again Requests Video (Media Feature Tags NOT Used). Party B does NOT signal its EI to offer a video telephony call and the 200 (OK) response includes an sdp offer with audio capabilities only. Party A’s EI accepts the audio offer and an ACK with an sdp answer accepting audio capability is sent back over the UC WAN to IP Party B. Party A again affirmatively signals its EI that it would like to add video to the telephony call and a re-INVITE with an sdp offer of audio and video capabilities is sent to IP Party B. Party B’s EI notifies IP Party B of the request to add video. Party B affirmatively signals its EI to accept the video telephony upgrade and a 200 (OK) response with an sdp answer accepting audio and video capabilities is sent over the UC WAN to IP Party A.

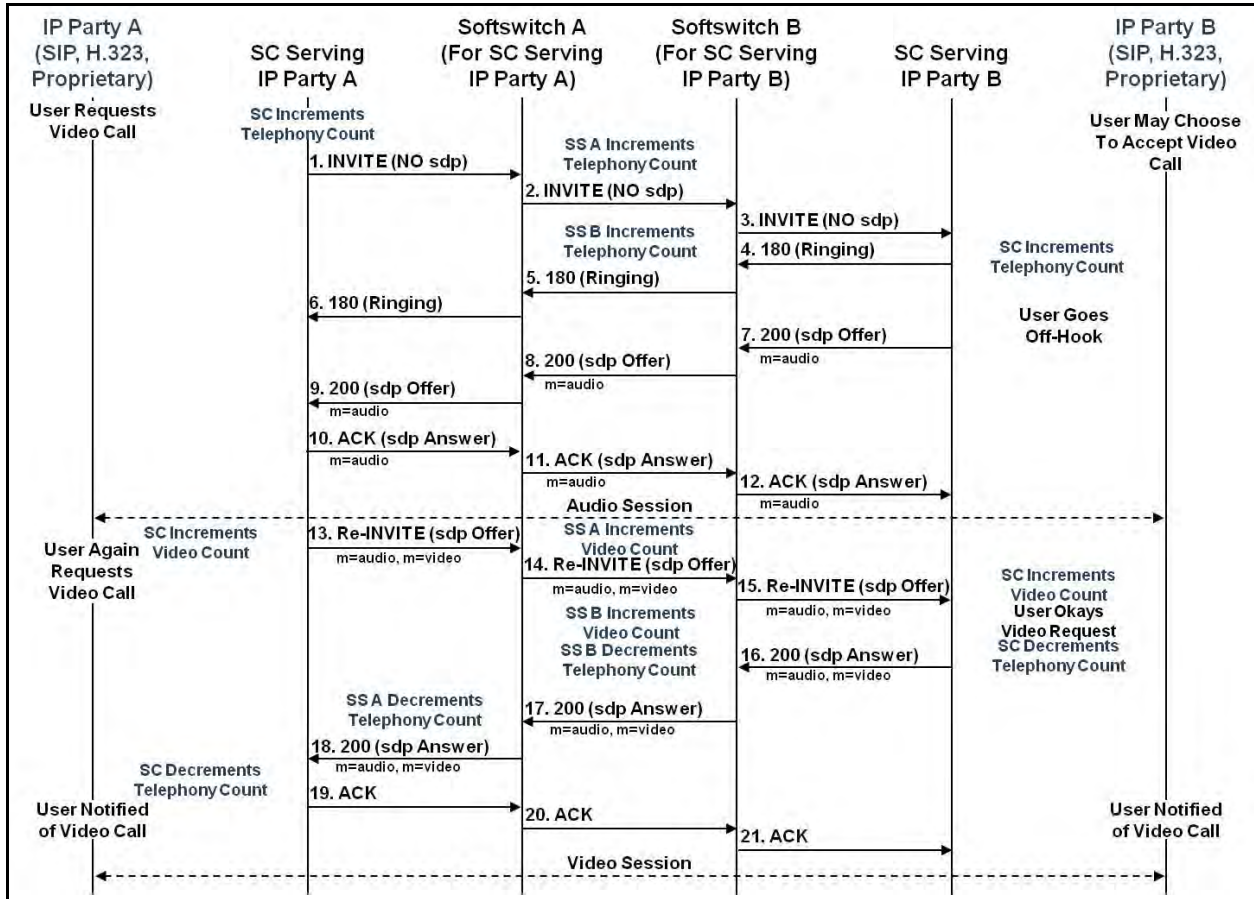

Figure 8.3-7. Empty INVITE – Caller Requests Video; Called Party Offers Audio; Caller Again Requests Video (Media Feature Tags NOT Used)

STEP	INSTRUCTION
1, 2, 3	Party A affirmatively signals to its EI an intention to initiate a video telephony call.
	Upon receiving an initial call request message from IP Party A (not depicted in the call flow diagram), the SC serving IP Party A either generates and sends an Empty INVITE to SS A or forwards an Empty INVITE (created by SIP EI A) to SS A. SS A forwards the Empty INVITE across the WAN to SS B (which is assigned to the SC serving IP Party B). SS B forwards the Empty INVITE to the SC serving IP Party B.
	When the SC serving IP Party B sends an Empty INVITE or other call request message to the IP EI serving Party B, then the EI MAY apprise Party B of the option of requesting a video call.
	NOTE: Signaling between the EI serving IP Party A and the SC serving IP Party A is not depicted. In addition, signaling between the SC serving IP Party B and the EI serving IP Party B is not depicted.

ASAC

Before sending 1, SC A increments telephony count.

Upon receiving 1, SS A increments telephony count.

Upon receiving 3, SC B increments telephony count.

STEP	INSTRUCTION
4, 5, 6	Assuming the EI is not busy, the SC serving IP Party B sends a 180 (Ringing) response to SS B. It forwards the 180 (Ringing) response to SS A, which forwards the 180 (Ringing) response to the SC serving IP Party A.
	NOTE: Signaling between the EI serving IP Party B and the SC serving IP Party B is not depicted. In addition, signaling between the SC serving IP Party A and the EI serving IP Party A is not depicted.

ASAC

Upon receiving 4, SS B increments telephony count.

STEP	INSTRUCTION
7, 8, 9	Party B does NOT signal to its EI an intention to engage in a video telephone call.
	When IP Party B goes off-hook (i.e., answers the call), the SC serving IP Party B sends a 200 (OK) response with an sdp offer of audio capabilities to SS B. SS B forwards the 200 (OK) response to SS A, which forwards the 200 (OK) response to the SC serving IP Party A.
	NOTE: Signaling between the EI serving IP Party B and the SC serving IP Party B is not depicted. In addition, signaling between the SC serving IP Party A and the EI serving IP Party A is not depicted.
10, 11, 12	Party A's EI accepts the audio telephone offer.
	The SC serving IP Party A sends an ACK with an sdp answer accepting audio capability to SS A. It forwards the ACK to SS B, which forwards the ACK to the SC serving IP Party B.
	NOTE: Signaling between the EI serving IP Party A and the SC serving IP Party A is not depicted. In addition, signaling between the SC serving IP Party B and the EI serving IP Party B is not depicted.
13, 14, 15	Party A affirmatively signals to its EI an intention to add video to the telephony call.
	Upon receiving call request/change message from IP Party A (not depicted in the call flow diagram), the SC serving IP Party A either generates and sends a re-INVITE with an sdp offering audio and video capabilities to SS A or forwards a re-INVITE with an sdp offering audio and video capabilities (created by SIP EI A) to SS A. SS A forwards the re-INVITE across the WAN to SS B (which is assigned to the SC serving IP Party B). SS B forwards the INVITE to the SC serving IP Party B.
	When the SC serving IP Party B sends the re-INVITE or equivalent call request message to the EI serving IP Party B, then Party B is notified by the EI that a video offer is being made, and Party B has the opportunity to affirmatively signal to the EI a desire to turn the existing call into a video telephony call.
	NOTE: Signaling between the EI serving IP Party A and the SC serving IP Party A is not depicted. In addition, signaling between the SC serving IP Party B and the EI serving IP Party B is not depicted.

ASAC

Before sending 13, SC A increments video count.

Upon receiving 13, SS A increments video count.

Upon receiving 15, SC B increments video count.

STEP	INSTRUCTION
16, 17, 18	Party B affirmatively signals its EI that Party B wishes to convert the call to a video telephony call.
	The SC serving IP Party B either generates and sends a 200 (OK) response with an sdp answer accepting audio and video capabilities to SS B or forwards a 200 (OK) response with an sdp answer accepting audio and video capabilities (created by SIP EI B) to SS B. SS B forwards the 200 (OK) response across the WAN to SS A. SS A forwards the INVITE to the SC serving IP Party B.
	Party B's EI notifies Party B that video has been added to the call.
	NOTE: Signaling between the EI serving IP Party B and the SC serving IP Party B is not depicted. In addition, signaling between the SC serving IP Party A and the EI serving IP Party A is not depicted.

ASAC

Before sending 16, SC B decrements telephony count.

Upon receiving 16, SS B increments video count and decrements telephony count.

Upon receiving 17, SS A decrements telephony count.

Upon receiving 18, SC A decrements telephony count.

STEP	INSTRUCTION
19, 20, 21	Party A's EI notifies Party A that video has been added to the call.
	The SC serving IP Party A sends an ACK to SS A. It forwards the ACK to SS B, which forwards the ACK to the SC serving IP Party B.
	NOTE: Signaling between the EI serving IP Party A and the SC serving IP Party AB is not depicted. In addition, signaling between the SC serving IP Party B and the EI serving IP Party B is not depicted.

8.3.4.1 Empty INVITE – Caller Requests Video; Called Party Offers Audio; Caller Again Requests Video (Media Feature Tags NOT Used) (AS-SIP EI Receives Empty INVITE)

The AS-SIP EIs do NOT generate initial Empty INVITES but they MUST accept Empty INVITES.

[Figure 8.3-8](#), Empty INVITE – Caller Requests Video; Called Party Offers Audio; Caller Again Requests Video (Media Feature Tags NOT Used) – AS-SIP EI Receives Empty INVITE, shows that AS-SIP EI B receives the Empty INVITE (Step 4) and responds with a 180 (Ringing) response (Step 5). The user at AS-SIP EI B does not indicate to AS-SIP EI B an intention to conduct a video request. The user at AS-SIP EI B goes off-hook and AS-SIP EI B sends a 200 (OK) response (Step 9) with an sdp offer for a telephony call. AS-SIP EI B receives an ACK

with an sdp answer accepting the telephony call (Step 16). AS-SIP EI B receives a re-INVITE offering a video session in an sdp (Step 20). AS-SIP EI B notifies user B of the video session request. User B signals acceptance of the video session request to AS-SIP EI B and AS-SIP EI B sends a 200 (OK) response with an sdp answer accepting the video session (Step 21). AS-SIP EI B verifies establishment of the video call to user B. AS-SIP EI B receives an ACK (Step 28).

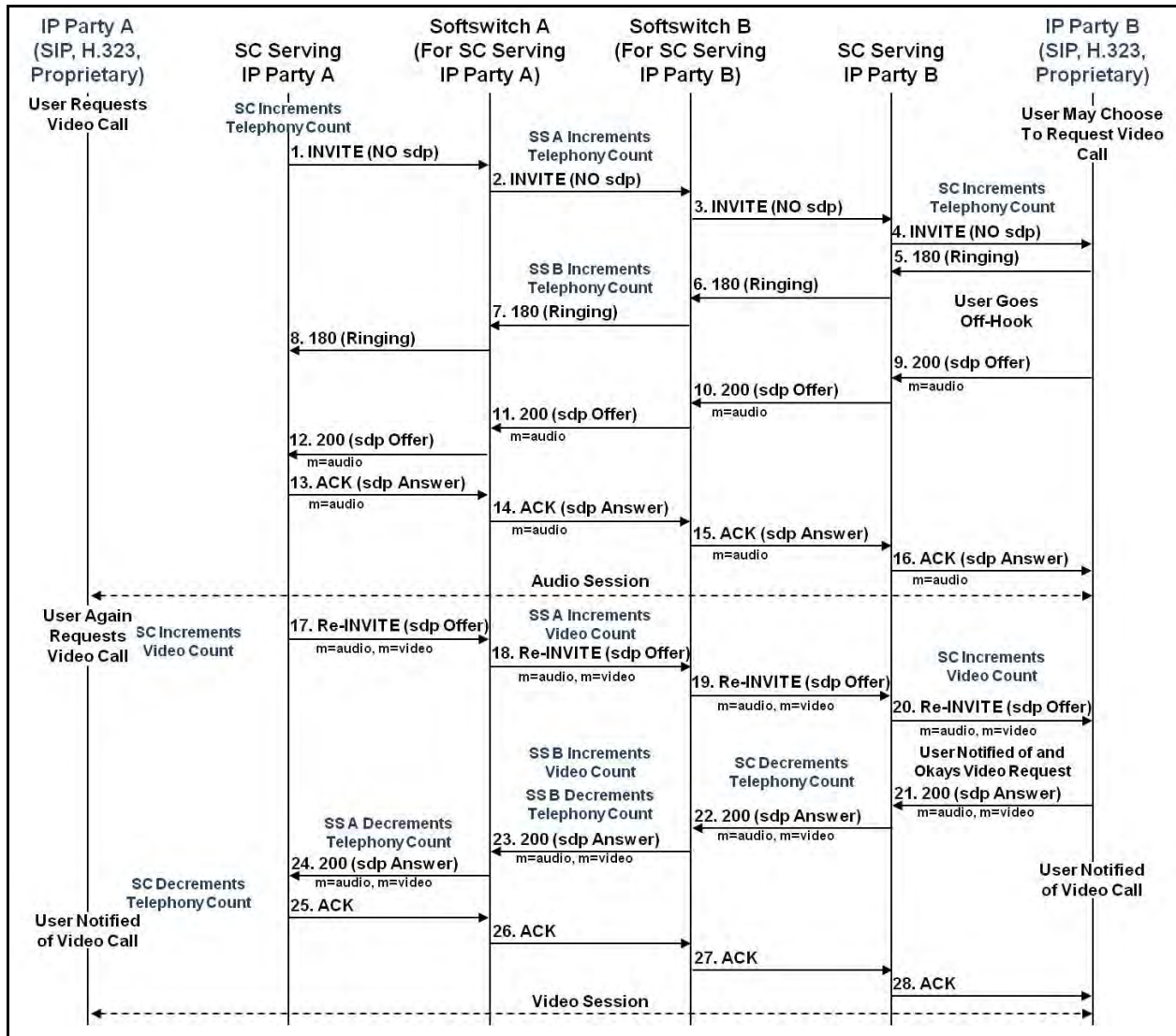

Figure 8.3-8. Empty INVITE – Caller Requests Video; Called Party Offers Audio; Caller Again Requests Video (Media Feature Tags NOT Used) – AS-SIP EI Receives Empty INVITE

8.3.5 Empty INVITE – Caller Requests Video; Called party Offers Video (Media Feature Tags Used by Originating SC and Terminating SC)

The AS-SIP message sequence in this call flow is identical to that of [Section 8.3.3](#), Empty INVITE – Caller Requests Video; Called Party Offers Video (Media Feature Tags NOT Used).

The use of media feature tags by the SCs alters the specific ASAC actions taken during the course of session establishment; however, the ASAC end state is the same as for [Section 8.3.3](#) [see [Figure 8.3-9](#), Empty INVITE – Caller Requests Video; Called Party Offers Video (Media Feature Tags Used by Originating SC and Terminating SC)].

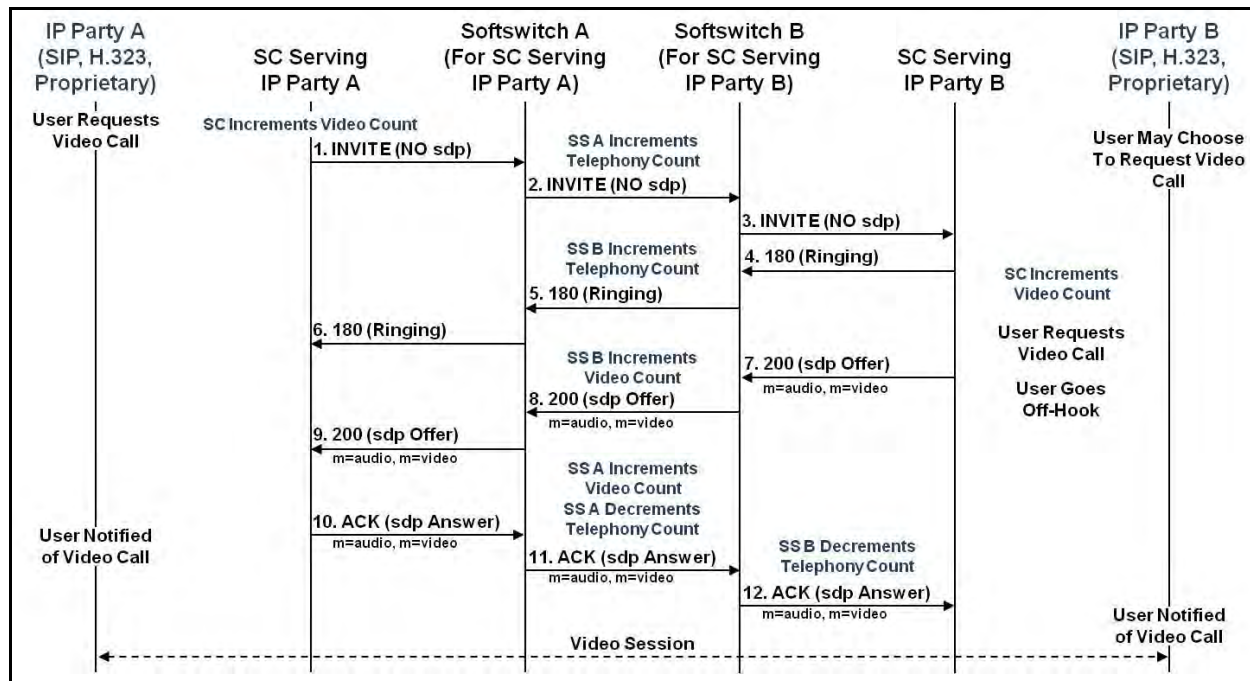

Figure 8.3-9. Empty INVITE – Caller Requests Video; Called Party Offers Video (Media Feature Tags Used by Originating SC and Terminating SC)

STEP	INSTRUCTION
1, 2, 3	Party A affirmatively signals to its EI an intention to initiate a video telephony call.
	Upon receiving an initial call request message from IP Party A (not depicted in the call flow diagram), the SC serving IP Party A either generates and sends an Empty INVITE to SS A or forwards an Empty INVITE (created by SIP EI A) to SS A. SS A forwards the Empty INVITE across the WAN to SS B (which is assigned to the SC serving IP Party B). SS B forwards the Empty INVITE to the SC serving IP Party B.
	When the SC serving IP Party B sends an Empty INVITE or other call request message to the IP EI serving Party B, then the EI MAY apprise Party B of the option of requesting a video call.
	NOTE: Signaling between the EI serving IP Party A and the SC serving IP Party A is not depicted. In addition, signaling between the SC serving IP Party B and the EI serving IP Party B is not depicted.

ASAC

Before sending 1, SC A increments video count.

Upon receiving 1, SS A increments telephony count.

Upon receiving 3, SC B increments video count.

STEP	INSTRUCTION
4, 5, 6	Assuming the EI is not busy, the SC serving IP Party B sends a 180 (Ringing) response to SS B. It forwards the 180 (Ringing) response to SS A, which forwards the 180 (Ringing) response to the SC serving IP Party A.
	NOTE: Signaling between the EI serving IP Party B and the SC serving IP Party B is not depicted. In addition, signaling between the SC serving IP Party A and the EI serving IP Party A is not depicted.

ASAC

Upon receiving 4, SS B increments telephony count.

STEP	INSTRUCTION
7, 8, 9	Party B affirmatively signals to its EI an intention to engage in a video telephone call.
	When IP Party B goes off-hook (i.e., answers the call), the SC serving IP Party B sends a 200 (OK) response with an sdp offer of audio and video capabilities to SS B. SS B forwards the 200 (OK) response to SS A, which forwards the 200 (OK) response to the SC serving IP Party A.
	NOTE: Signaling between the EI serving IP Party B and the SC serving IP Party B is not depicted. In addition, signaling between the SC serving IP Party A and the EI serving IP Party A is not depicted.

ASAC

Upon receiving 7, SS B increments video count.

STEP	INSTRUCTION
10, 11, 12	Since the caller had affirmatively signaled to the EI a desire to engage in a video telephone call and the initial offer from the remote side is a video telephone offer, then the EI will accept the video telephone offer.
	EI A notifies Party A that a video call has been established.
	The SC serving IP Party A sends an ACK with an sdp answer accepting audio and video capabilities to SS A. It forwards the ACK to SS B, which forwards the ACK to the SC serving IP Party B.
	EI B notifies Party B that a video call has been established.
	NOTE: Signaling between the EI serving IP Party A and the SC serving IP Party A is not depicted. In addition, signaling between the SC serving IP Party B and the EI serving IP Party B is not depicted.

ASAC

Upon receiving 10, SS A increments video count and decrements telephony count.

Upon receiving 11, SS B decrements telephony count.

8.3.5.1 Empty INVITE – Caller Requests Video; Called Party Offers Video (Media Feature Tags Used by Originating SC and Terminating SC) – AS-SIP EI Receives Empty INVITE

The AS-SIP EIs do NOT generate initial empty INVITES but they MUST accept empty INVITES.

Figure 8.3-10, Empty INVITE – Caller Requests Video; Called Party Offers Video, shows User A requesting a video call and shows SC A sending an empty INVITE (including the audio and video media feature tags) to AS-SIP EI B served by SC B.

SC A increments the video call count by at least one VSU and sends out an empty INVITE (Step 1). Upon receiving the empty INVITE, SS A (which does not understand media feature tags) increments the telephony call count. When SC B receives the empty INVITE (Step 3), then SC B (which understands media feature tags) increments the video count by at least one VSU.

AS-SIP EI B receives the empty INVITE (Step 4) and responds with 180 ringing (Step 5). When SS B receives 180 ringing (Step 6), then SS B increments the telephony call count (as SS B did not understand the media feature tags received in the original empty INVITE (Step 2).

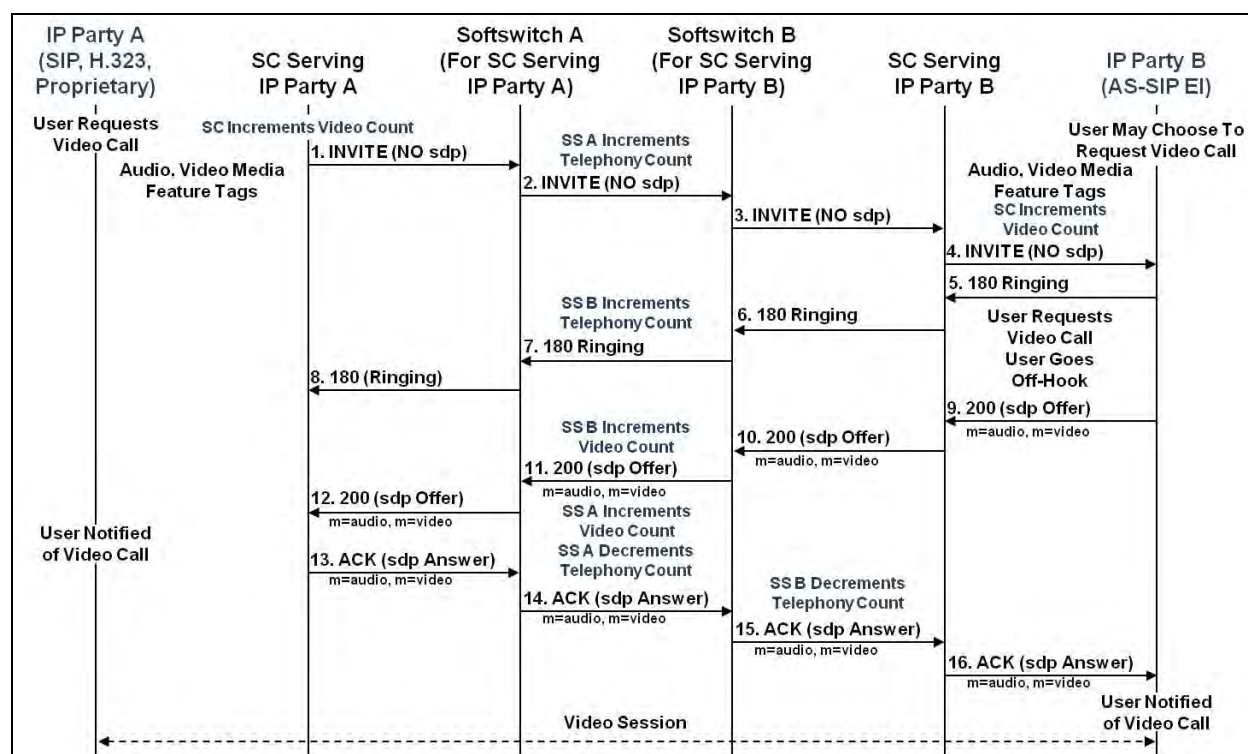

Figure 8.3-10. Empty INVITE – Caller Requests Video; Called Party Offers Video (Media Feature Tags Used by Originating SC and Terminating SC)

User B requests that AS-SIP EI B engage in a video call and when User B goes off-hook AS-SIP EI B sends a 200 (OK) response (Step 9) with an sdp offering audio and video capabilities. Upon

receiving the 200 (OK) response (Step 10) SS B increments the video call count. Upon receiving the 200 (OK) response (Step 11), SS A increments the video call count.

User A is notified that a video call is being established and SC A sends an ACK (Step 13) with an sdp answer that accepts the video call. Upon receiving the ACK (Step 13), SS A increments the video count and decrements the telephony count. Upon receiving the ACK (Step 14), SS B decrements the telephony count. When AS-SIP EI B receives the ACK with an sdp answer accepting video session (Step 16), it notifies User B that the video call is established.

8.3.6 Empty INVITE – Caller Requests Video; Called Party Offers Audio – Calling Party Again Requests Video (Media Feature Tags Used by Originating SC and Terminating SC)

The AS-SIP message sequence in this call flow is identical to that of [Section 8.3.4](#), Empty INVITE – Caller Requests Video; Called Party Offers Audio; Caller Again Requests Video (Media Feature Tags NOT Used). The use of media feature tags by the SCs alters the specific ASAC actions taken during the course of session establishment; however, the ASAC end state is the same as for [Section 8.3.4](#) (see [Figure 8.3-11](#), Empty INVITE – Caller Requests Video; Called Party Offers Audio – Calling Party Again Requests Video [Media Feature Tags Used by Originating SC and Terminating SC]).

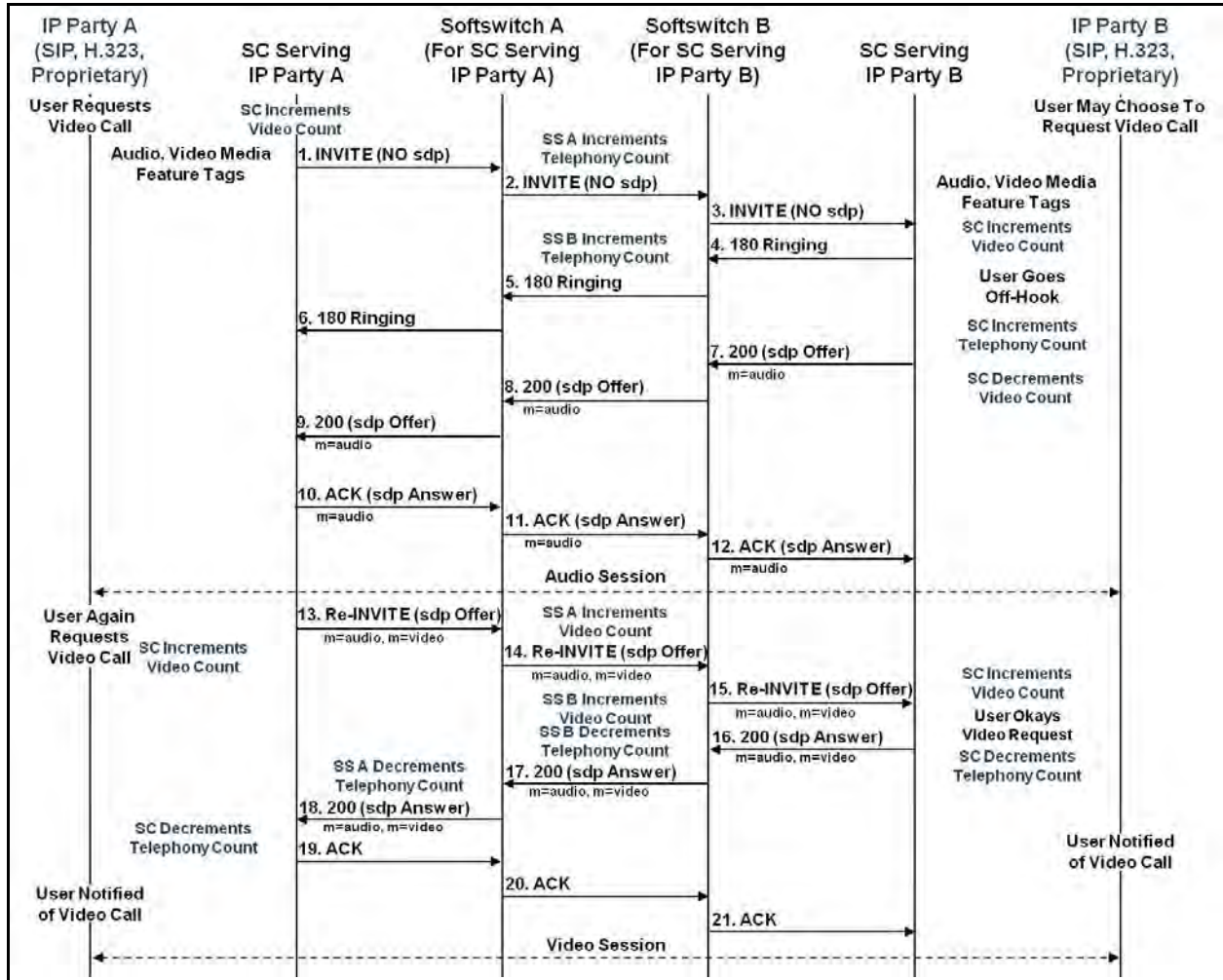

Figure 8.3-11. Empty INVITE – Caller Requests Video; Called Party Offers Audio – Calling Party Again Requests Video (Media Feature Tags Used by Originating SC and Terminating SC)

STEP	INSTRUCTION
1, 2, 3	Party A affirmatively signals to its EI an intention to initiate a video telephony call.
	Upon receiving an initial call request message from IP Party A (not depicted in the call flow diagram), the SC serving IP Party A either generates and sends an Empty INVITE to SS A or forwards an Empty INVITE (created by SIP EI A) to SS A. SS A forwards the Empty INVITE across the WAN to SS B (which is assigned to the SC serving IP Party B). SS B forwards the Empty INVITE to the SC serving IP Party B.
	When SC serving IP Party B sends an Empty INVITE or other call request message to the IP EI serving Party B, then the EI MAY apprise Party B of the option of requesting a video call.
	NOTE: Signaling between the EI serving IP Party A and the SC serving IP Party A is not depicted. In addition, signaling between the SC serving IP Party B and the EI serving IP Party B is not depicted.

ASAC

Before sending 1, SC A increments video count.

Upon receiving 1, SS A increments telephony count.

Upon receiving 3, SC B increments video count.

STEP	INSTRUCTION
4, 5, 6	Assuming the EI is not busy, the SC serving IP Party B sends a 180 (Ringing) response to SS B. It forwards the 180 (Ringing) response to SS A, which forwards the 180 (Ringing) response to the SC serving IP Party A.
	NOTE: Signaling between the EI serving IP Party B and the SC serving IP Party B is not depicted. In addition, signaling between the SC serving IP Party A and the EI serving IP Party A is not depicted.

ASAC

Upon receiving 4, SS B increments telephony count.

STEP	INSTRUCTION
7, 8, 9	Party B does NOT signal to its EI an intention to engage in a video telephone call.
	When IP Party B goes off-hook (i.e., answers the call), the SC serving IP Party B sends a 200 (OK) response with an sdp offer of audio capabilities to SS B. SS B forwards the 200 (OK) response to SS A, which forwards the 200 (OK) response to the SC serving IP Party A.
	NOTE: Signaling between the EI serving IP Party B and the SC serving IP Party B is not depicted. In addition, signaling between the SC serving IP Party A and the EI serving IP Party A is not depicted.

ASAC

Before sending 7, SC B increments telephony count and decrements video count.

Upon receiving 9, SC A increments telephony count.

STEP	INSTRUCTION
10, 11, 12	Party A's EI accepts the audio telephone offer.
	The SC serving IP Party A sends an ACK with an sdp answer accepting audio capability to SS A. It forwards the ACK to SS B, which forwards the ACK to the SC serving IP Party B.
	NOTE: Signaling between the EI serving IP Party A and the SC serving IP Party A is not depicted. In addition, signaling between the SC serving IP Party B and the EI serving IP Party B is not depicted.

ASAC

Before sending 10, SC A decrements video count.

STEP	INSTRUCTION
13, 14, 15	Party A affirmatively signals to its EI an intention to add video to the telephony call.
	Upon receiving a call request/change message from IP Party A (not depicted in the call flow diagram), the SC serving IP Party A either generates and sends a re-INVITE with an sdp offering audio and video capabilities to SS A or forwards a re-INVITE with an sdp offering audio and video capabilities (created by SIP EI A) to SS A. SS A forwards the re-INVITE across the WAN to SS B (which is assigned to the SC serving IP Party B). SS B forwards the INVITE to the SC serving IP Party B.
	When the SC serving IP Party B sends the re-INVITE or equivalent call request message to the EI serving IP Party B, then Party B is notified by the EI that a video offer is being made, and Party B has the opportunity to affirmatively signal to the EI a desire to turn the existing call into a video telephony call.
	NOTE: Signaling between the EI serving IP Party A and the SC serving IP Party A is not depicted. In addition, signaling between the SC serving IP Party B and the EI serving IP Party B is not depicted.

ASAC

Before sending 13, SC A increments video count.

Upon receiving 13, SSA increments video count.

Upon receiving 15, SC B increments video count.

STEP	INSTRUCTION
16, 17, 18	Party B affirmatively signals its EI that Party B wishes to convert the call to a video telephony call.
	The SC serving IP Party B either generates and sends a 200 (OK) response with an sdp answer accepting audio and video capabilities to SS B or forwards a 200 (OK) response with an sdp answer accepting audio and video capabilities (created by SIP EI B) to SS B. SS B forwards the 200 (OK) response across the WAN to SS A. SS A forwards the INVITE to the SC serving IP Party B.
	Party B's EI notifies Party B that video has been added to the call.
	NOTE: Signaling between the EI serving IP Party B and the SC serving IP Party B is not depicted. In addition, signaling between the SC serving IP Party A and the EI serving IP Party A is not depicted.

ASAC

Before sending 16, SC B decrements telephony count.

Upon receiving 16, SS B increments video count and decrements telephony count.

Upon receiving 17, SS A decrements telephony count.

Upon receiving 18, SC A decrements telephony count.

STEP	INSTRUCTION
19, 20, 21	Party A's EI notifies Party A that video has been added to the call.

STEP	INSTRUCTION
	The SC serving IP Party A sends an ACK to SS A. It forwards the ACK to SS B, which forwards the ACK to the SC serving IP Party B.
	NOTE: Signaling between the EI serving IP Party A and the SC serving IP Party AB is not depicted. In addition, signaling between the SC serving IP Party B and the EI serving IP Party B is not depicted.

8.4 POINT-TO-POINT VIDEO CONFERENCE UNIT CALL FLOWS

8.4.1 VCU INVITE With sdp Video Offer

The originating SC sends an INVITE that includes an sdp offer of audio and video capabilities on behalf of VCU A. The terminating SC responds with a 200 sdp answer accepting audio and video capabilities on behalf of VCU B (see [Figure 8.4-1](#)), VCU INVITE with sdp Video Offer).

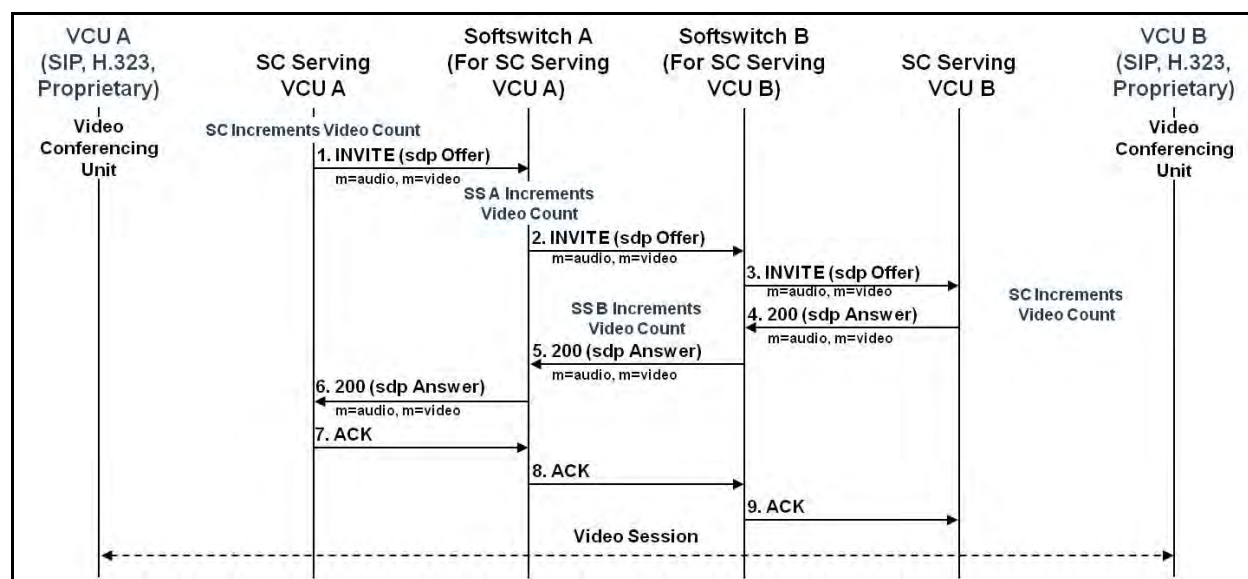

Figure 8.4-1. VCU INVITE With sdp Video Offer

STEP	INSTRUCTION
1, 2, 3	Upon receiving an initial call request message from VCU A (not depicted in the call flow diagram), the SC serving VCU A either generates and sends an INVITE with an sdp offer for audio and video capabilities to SS A or forwards an INVITE with an sdp offer for audio and video capabilities (created by VCU A) to SS A. SS A forwards the INVITE across the WAN to SS B (which is assigned to the SC serving VCU B). SS B forwards the INVITE to the SC serving VCU B.
	NOTE: Signaling between VCU A and the SC serving VCU A is not depicted. In addition, signaling between the SC serving VCU B and VCU B is not depicted.

ASAC

Before sending 1, SC A increments video count.

Upon receiving 1, SS A increments video count.

Upon receiving 3, SC B increments video count.

STEP	INSTRUCTION
4, 5, 6	When VCU B answers the call, the SC serving VCU B sends a 200 (OK) response with an sdp answer accepting audio and video capabilities to SS B. SS B forwards the 200 (OK) response to SS A, which forwards the 200 (OK) response to the SC serving VCU A.
	NOTE: Signaling between VCU B and the SC serving VCU B is not depicted. In addition, signaling between the SC serving VCU A and VCU A is not depicted.

ASAC

Upon receiving 4, SS B increments video count.

STEP	INSTRUCTION
7, 8, 9	The SC serving VCU A sends an ACK to SS A. It forwards the ACK to SS B, which forwards the ACK to the SC serving VCU B.
	NOTE: Signaling between VCU A and the SC serving VCU A is not depicted. In addition, signaling between the SC serving VCU B and VCU B is not depicted.

8.4.1.1 VCU INVITE With sdp Video Offer (AS-SIP VCU EI)

[Figure 8.4-2](#), VCU INVITE with sdp Video Offer (AS-SIP VCU EI), shows AS-SIP VCU EI A sending an INVITE with an sdp video offer (Step 1). AS-SIP VCU EI B receives the INVITE (Step 5) and responds with a 200 (OK) response with an sdp answer accepting the video call offer (Step 6). AS-SIP VCU EI A receives the 200 (OK) response (Step 10) and sends an ACK (Step 11). AS-SIP VCU EI B receives the ACK (Step 15).

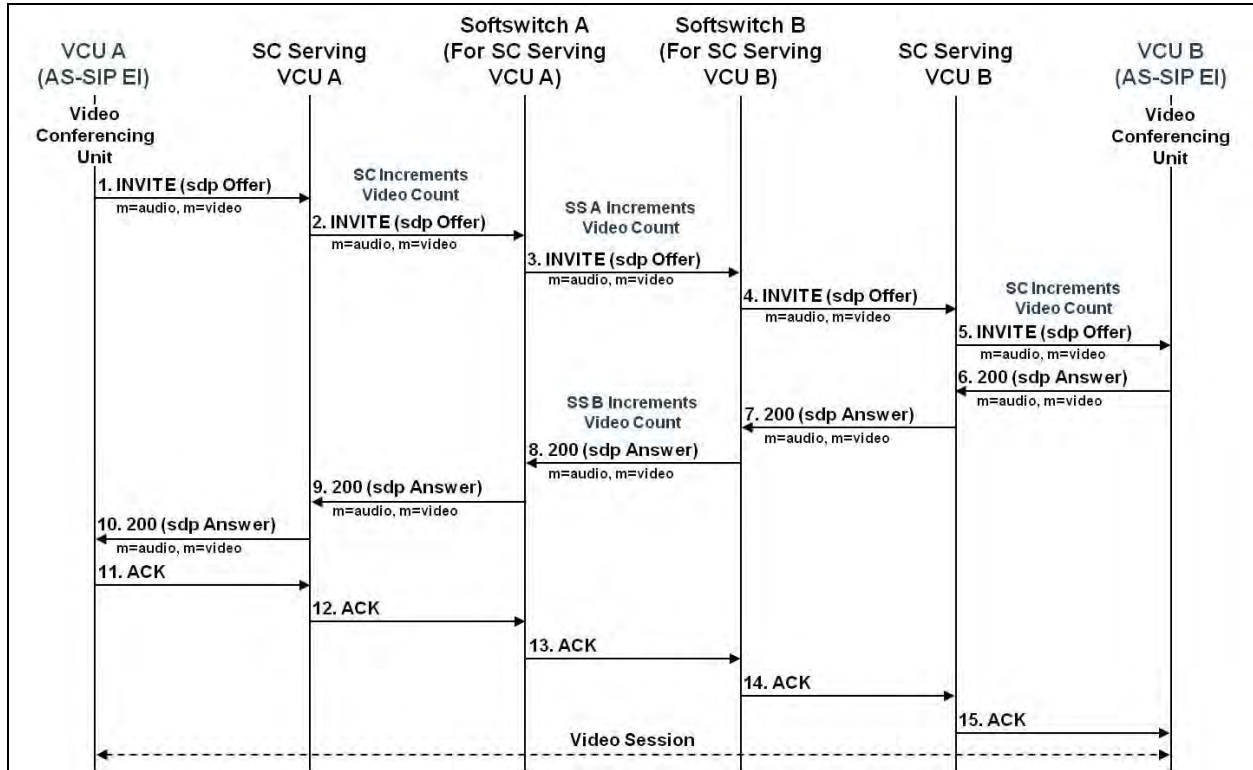

Figure 8.4-2. VCU INVITE With sdp Video Offer (AS-SIP VCU EI)

8.4.2 VCU Empty INVITE (Media Feature Tags NOT Used)

The originating SC sends an Empty INVITE. The terminating SC responds with a 200 sdp offer of audio and video capabilities on behalf of VCU B. VCU A accepts audio and video capabilities and the originating SC responds with an ACK request that includes an sdp answer accepting the audio and video capabilities (see [Figure 8.4-3](#), VCU Empty INVITE (Media Feature Tags NOT Used)).

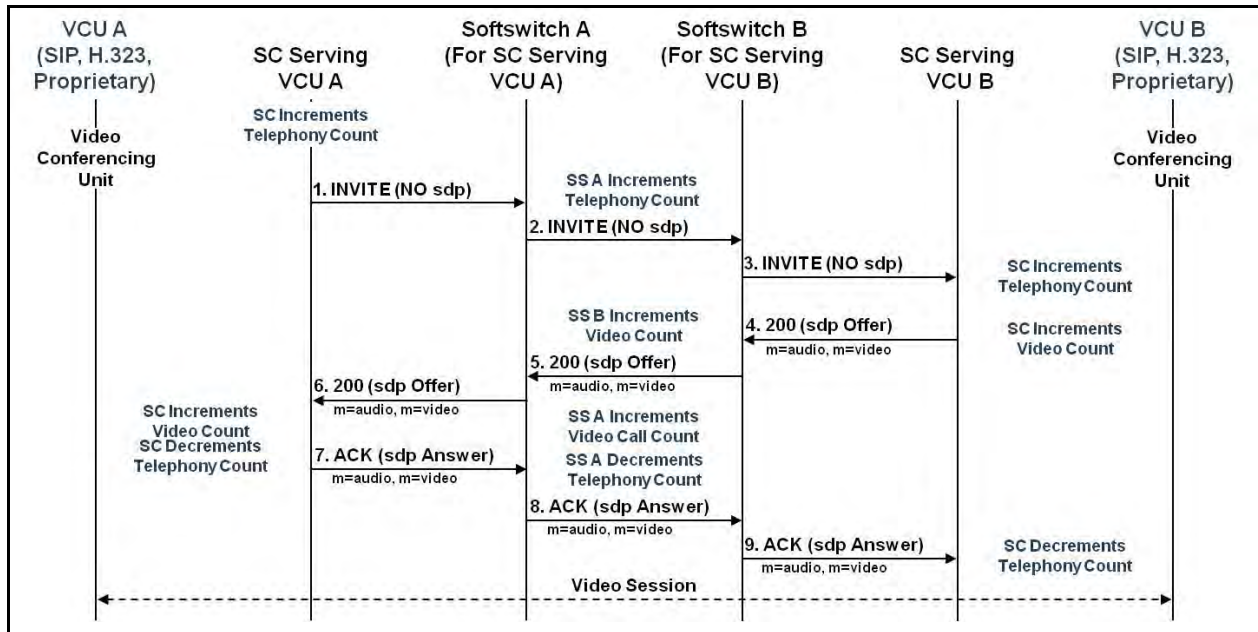

Figure 8.4-3. VCU Empty INVITE (Media Feature Tags NOT Used)

STEP	INSTRUCTION
1, 2, 3	Upon receiving an initial call request message from VCU A (not depicted in the call flow diagram), the SC serving VCU A either generates and sends an Empty INVITE to SS A or forwards an Empty INVITE (created by VCU A) to SS A. SS A forwards the Empty INVITE across the WAN to SS B (which is assigned to the SC serving VCU B). SS B forwards the Empty INVITE to the SC serving VCU B.
	NOTE: Signaling between VCU A and the SC serving VCU A is not depicted. In addition, signaling between the SC serving VCU B and VCU B is not depicted.

ASAC

Before sending 1, SC A increments telephony count.

Upon receiving 1, SS A increments telephony count.

Upon receiving 3, SC B increments telephony count.

STEP	INSTRUCTION
4, 5, 6	VCU B answers the call and the SC serving VCU B sends a 200 (OK) response with an sdp offer for audio and video capabilities to SS B. SS B forwards the 200 (OK) response to SS A, which forwards the 200 (OK) response to the SC serving VCU A.
	NOTE: Signaling between VCU B and the SC serving VCU B is not depicted. In addition, signaling between the SC serving VCU A and VCU A is not depicted.

ASAC

Before sending 4, SC B increments video count.

Upon receiving 4, SS B increments video count.

Upon receiving 6, SC A increments video count.

STEP	INSTRUCTION
7, 8, 9	VCU A accepts the video offer and the SC serving VCU A sends an ACK with an sdp answer accepting audio and video capabilities to SS A. It forwards the ACK to SS B, which forwards the ACK to the SC serving VCU B.
	NOTE: Signaling between VCU A and the SC serving VCU A is not depicted. In addition, signaling between the SC serving VCU B and VCU B is not depicted.

ASAC

Before sending 7, SC A decrements telephony count.

Upon receiving 7, SS A increments video count and decrements telephony count.

Upon receiving 9, SC B decrements telephony count

8.4.2.1 VCU Empty INVITE (Media Feature Tags NOT Used) – AS-SIP VCU EIs

The AS-SIP VCU EIs do NOT generate initial Empty INVITES but they MUST accept Empty INVITES.

[Figure 8.4-4](#), VCU Empty INVITE (Media Feature Tags NOT Used) – AS-SIP EI, shows that AS-SIP VCU EI B receives the Empty INVITE (Step 4) and responds with 200 (OK) response with an sdp offer for a video session (Step 5). AS-SIP VCU EI B receives an ACK with an sdp answer accepting the video session (Step 12).

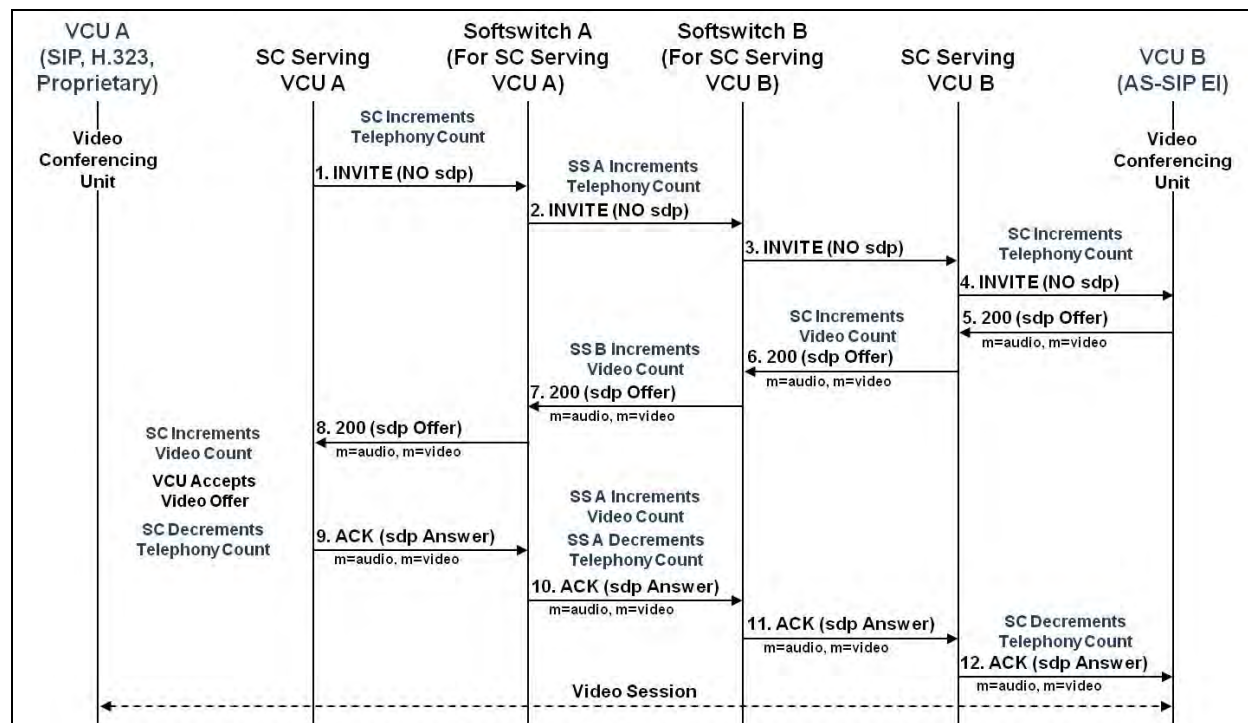

Figure 8.4-4. VCU Empty INVITE (Media Feature Tags NOT Used) – AS-SIP EI

8.4.3 VCU Empty INVITE (Media Feature Tags Used by Originating SC and Terminating SC)

The AS-SIP message sequence in this call flow is identical to that of [Section 8.4.2](#), VCU Empty INVITE (Media Feature Tags NOT Used). The use of media feature tags by the SCs alters the specific ASAC actions taken during the course of session establishment; however, the ASAC end state is the same as for [Section 8.4.2](#) (see [Figure 8.4-5](#), VCU Empty INVITE (Media Feature Tags Used by Originating SC and Terminating SC)).

NOTE: The AS-SIP VCU EIs are not required to be capable of generating media feature tags or to be capable of receiving/processing media feature tags; however, an AS-SIP VCU EI that receives but does not understand media feature tags MUST ignore them and MUST NOT reject the call solely because of the presence of a media feature tag in the Contact header.

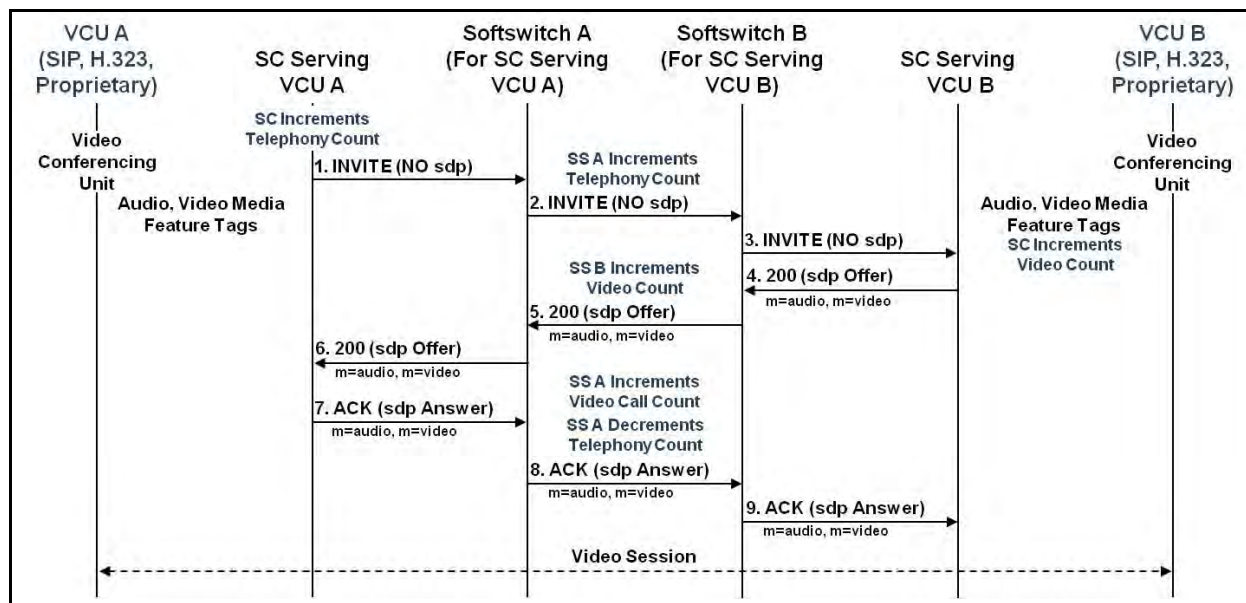

Figure 8.4-5. VCU Empty INVITE (Media Feature Tags Used by Originating SC and Terminating SC)

STEP	INSTRUCTION
1, 2, 3	Upon receiving an initial call request message from VCU A (not depicted in the call flow diagram), the SC serving VCU A either generates and sends an Empty INVITE to SS A or forwards an Empty INVITE (created by VCU A) to SS A. SS A forwards the Empty INVITE across the WAN to SS B (which is assigned to the SC serving VCU B). SS B forwards the Empty INVITE to the SC serving VCU B.
	NOTE: Signaling between VCU A and the SC serving VCU A is not depicted. In addition, signaling between the SC serving VCU B and VCU B is not depicted.

ASAC

Before sending 1, SC A increments video count.

Upon receiving 1, SS A increments telephony count.

Upon receiving 3, SC B increments video count.

STEP	INSTRUCTION
4, 5, 6	VCU B answers the call and the SC serving VCU B sends a 200 (OK) response with an sdp offer for audio and video capabilities to SS B. SS B forwards the 200 (OK) response to SS A, which forwards the 200 (OK) response to the SC serving VCU A.
	NOTE: Signaling between VCU B and the SC serving VCU B is not depicted. In addition, signaling between the SC serving VCU A and VCU A is not depicted.

ASAC

Upon receiving 4, SS B increments video count.

STEP	INSTRUCTION
7, 8, 9	VCU A accepts the video offer and the SC serving VCU A sends an ACK with an sdp answer accepting audio and video capabilities to SS A. It forwards the ACK to SS B, which forwards the ACK to the SC serving VCU B.
	NOTE: Signaling between VCU A and the SC serving VCU A is not depicted. In addition, signaling between the SC serving VCU B and VCU B is not depicted.

ASAC

Upon receiving 7, SS A increments video count and decrements telephony count.

8.4.3.1 VCU Empty INVITE (Media Feature Tags Used) – AS-SIP VCU EIs

The AS-SIP VCU EIs do NOT generate Empty INVITES but they MUST accept Empty INVITES.

[Figure 8.4-6](#), VCU Empty INVITE (Media Feature Tags Used) – AS-SIP EI, shows that AS-SIP VCU EI B receives the Empty INVITE (Step 4) and responds with 200 (OK) response with an sdp offer for a video session (Step 5). AS-SIP VCU EI B receives an ACK with an sdp answer accepting the video session (Step 12).

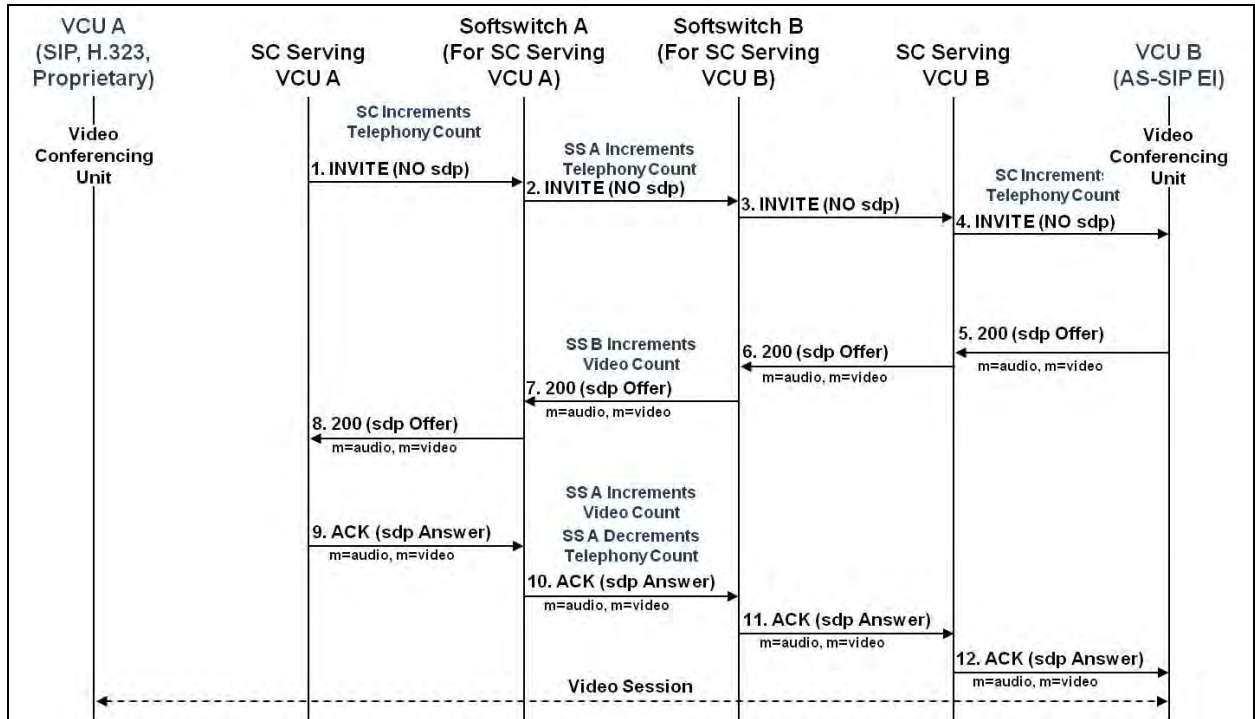

Figure 8.4-6. VCU Empty INVITE (Media Feature Tags Used) – AS-SIP EI

SECTION 9 CALLING SERVICES

9.1 INTRODUCTION

Many calling features are traditional to the TDM network and the PSTN. Within the PSTN, some calling features are required by law and regulated by the Federal Communications Commission (FCC). This specification is used within the context of a private network and thus is not necessarily subject to the same laws and regulations.

The call features presented in this section (i.e., Point-to-Point Call, Call Hold, Call Waiting, Call Forward (Unconditional, No Answer, Busy), Call Transfer, Three-Way Call) are required for the near-term open loop architecture. The near-term open loop architecture also requires AS-SIP to support the fax and modem services.

The call flow diagrams assume the two-tier hierarchical architecture where for incoming or outgoing calls to be established across the UC WAN, the SC at a B/P/C/S exchanges its AS-SIP messages with a network-controlled SS.

NOTE: ~~UCR, Sec. 9.6.02 UCR 2013 sec 2.9~~ defines requirements associated with ~~end instruments including AS-SIP EIs with P&P (voice and video), RO AS-SIP EIs (voice and video) and AS-SIP secure voice EIs.~~ ~~three categories of AS-SIP EIs: AS-SIP voice EIs, AS-SIP secure voice EIs, AS-SIP video EIs.~~ Moreover, the specific category to which an AS-SIP EI belongs determines the applicable set of mandatory and optional calling services for the given AS-SIP EI. ~~In particular, UCR Sec. 9.6.1 identifies the calling services whose support is mandatory for AS-SIP voice EIs and whose support is conditional for AS-SIP voice EIs. UCR Sec. 9.6.2 identifies the calling services whose support is mandatory for AS-SIP secure voice EIs and whose support is conditional for AS-SIP secure voice EIs. UCR Sec. 9.6.3 identifies the calling services whose support is mandatory for AS-SIP video EIs and whose support is conditional for AS-SIP video EIs.~~

~~In addition, UCR Sec. 9.6.2 summarizes requirements common to all categories of AS-SIP EIs.~~

9.2 POINT-TO-POINT CALL

Signaling requirements for point-to-point calls are described for the following three call conditions:

- No reliable provisional response, no preconditions.
- Segmented precondition.
- End-to-end precondition.

9.2.1 IP-to-IP Call Type

9.2.1.1 Successful Basic IP-to-IP Call (No Reliable Provisional Responses, No Preconditions)

SIP-006120 [Figure 9.2-1](#), Successful Basic IP-to-IP Call (No Reliable Provisional Responses, No Preconditions), depicts the sequence of AS-SIP messages between the SC serving IP Party A and the SC serving IP Party B used to establish, and then tear down a telephony session between the parties. The call flow diagram does not depict reliable provisional responses or the use of preconditions.

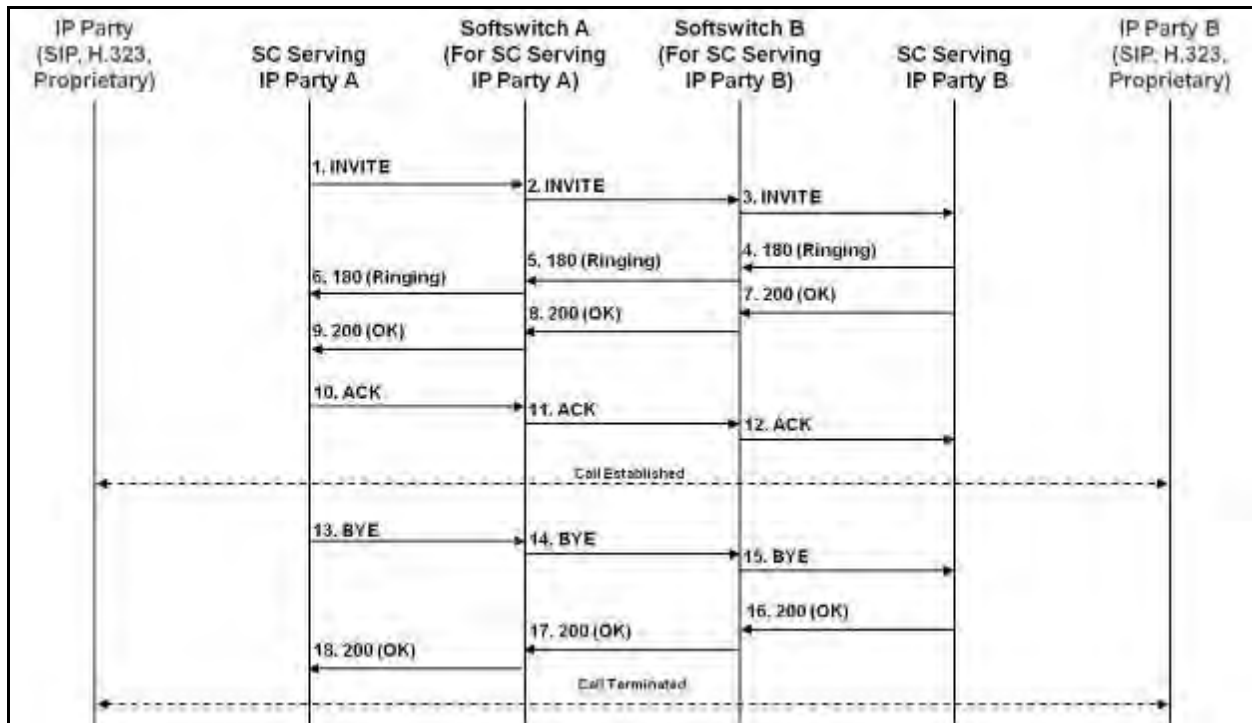

**Figure 9.2-1. Successful Basic IP-to-IP Call
(No Reliable Provisional Responses, No Preconditions)**

NOTE: If the INVITE has an sdp offer, then the sdp answer is in the 200 (OK) response. If the INVITE does not have an sdp offer (i.e., Empty INVITE), then the sdp offer is placed in the 200 (OK) response and the sdp answer is placed in the ACK.

Call Establishment

STEP	INSTRUCTION
1, 2, 3	Upon receiving an initial call request message from IP Party A (not depicted in the call flow diagram), the SC serving IP Party A sends an INVITE to its assigned SS (SS A). SS A forwards the INVITE across the WAN to the SS B, which is assigned to the SC serving IP Party B. SS B forwards the INVITE to the SC serving IP Party B.

STEP	INSTRUCTION
	NOTE: Signaling is not depicted between the EI serving IP Party A and the SC serving IP Party A. In addition, signaling is not depicted between the SC serving IP Party B and the EI serving IP Party B.
4, 5, 6	Assuming the EI is not busy, the SC serving IP Party B sends a 180 (Ringing) response to SS B. It forwards the 180 (Ringing) response to SS A, which forwards the 180 (Ringing) response to the SC serving IP Party A.
	NOTE: Signaling is not depicted between the EI serving IP Party B and the SC serving IP Party B. In addition, signaling is not depicted between the SC serving IP Party A and the EI serving IP Party A.
7, 8, 9	When IP Party B goes off-hook (i.e., answers the call), the SC serving IP Party B sends a 200 (OK) response to SS B. It forwards the 200 (OK) response to SS A, which forwards the 200 (OK) response to the SC serving IP Party A.
	NOTE: Signaling is not depicted between the EI serving IP Party B and the SC serving IP Party B. In addition, signaling is not depicted between the SC serving IP Party A and the EI serving IP Party A.
10, 11, 12	The SC serving IP Party A sends an ACK to SS A. It forwards the ACK to SS B, which forwards the ACK to the SC serving IP Party B.
	NOTE: Signaling is not depicted between the EI serving IP Party A and the SC serving IP Party A. In addition, signaling is not depicted between the SC serving IP Party B and the EI serving IP Party B.

Call Release

STEP	INSTRUCTION
13, 14, 15	The SC serving IP Party A sends a BYE request to SS A. It forwards the BYE request to SS B, which forwards the BYE request to the SC serving IP Party B.
	NOTE: Signaling is not depicted between the EI serving IP Party A and the SC serving IP Party A that initiated the call release. In addition, signaling is not depicted between the SC serving IP Party B and the EI serving IP Party B.
16, 17, 18	The SC serving IP Party B sends a 200 (OK) response to SS B. It forwards the 200 (OK) response to SS A, which forwards the 200 (OK) response to the SC serving IP Party A.
	NOTE: Signaling is not depicted between the EI serving IP Party B and the SC serving IP Party B. In addition, signaling is not depicted between the SC serving IP Party A and the EI serving IP Party A.

9.2.1.1.1 Successful Basic IP-to-IP Call (AS-SIP EI)

SIP-006130 [Figure 9.2-2](#), Successful Basic IP-to-IP Call (No Reliable Provisional Responses, No Preconditions) (AS-SIP EIs), shows that AS-SIP EI A sends an INVITE with an sdp offer for a telephony call (Step 1). AS-SIP EI B receives the INVITE (Step 5) and responds with a 180 (Ringing) response (Step 6). AS-SIP EI A receives the 180 (Ringing) response (Step 10). The user at AS-SIP EI B goes off-hook and EI B sends a 200 (OK) response with an sdp answer accepting the telephony call. AS-SIP EI A receives the 200 (OK) response (Step 15). AS-SIP EI

A sends an ACK (Step 16) and AS-SIP EI B receives the ACK (Step 20). The call is now established.

To terminate the call, AS-SIP EI A sends a BYE request (Step 21), which is received by AS-SIP EI B (Step 25). The AS-SIP EI B responds with 200 (OK) response (Step 26) that is received at AS-SIP EI A (Step 30). When the 200 (OK) response reaches each AS-SIP signaling appliance, the AS-SIP signaling appliance reduces the telephony count by one.

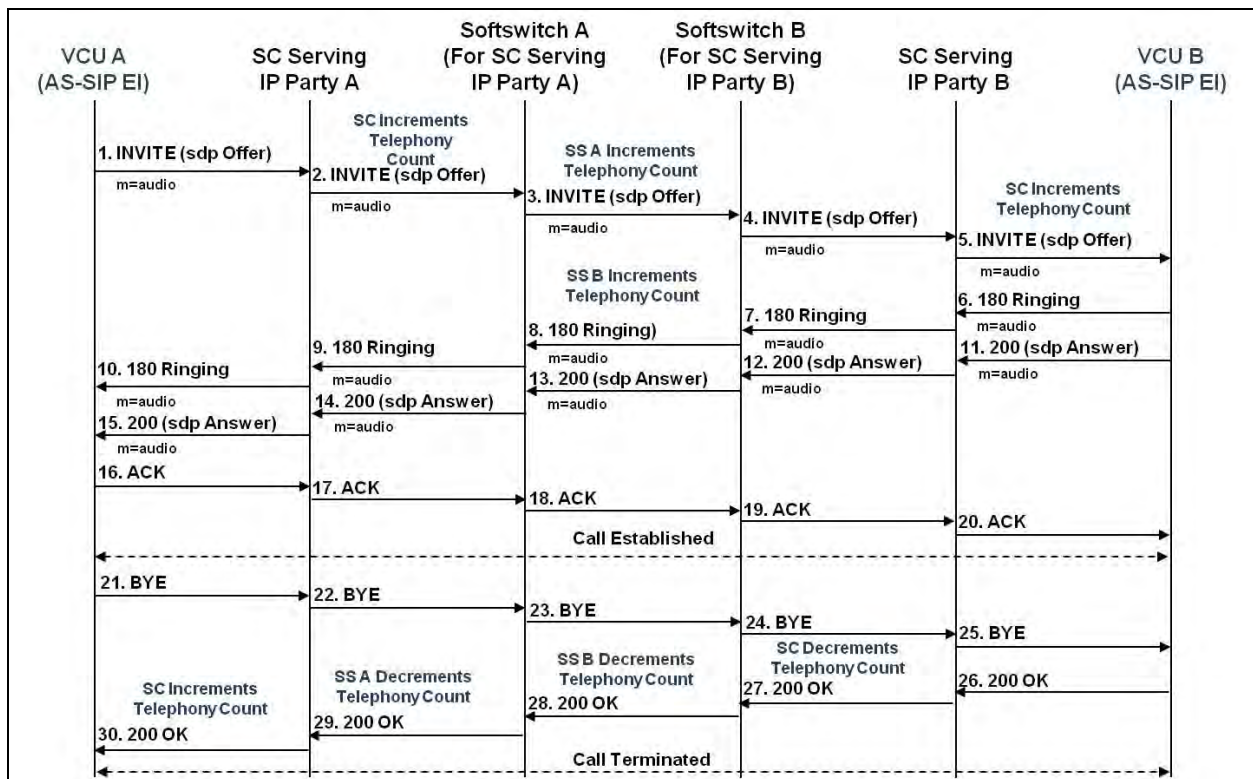

Figure 9.2-2. Successful Basic IP-to-IP Call (No Reliable Provisional Responses, No Preconditions) (AS-SIP EIs)

9.2.1.2 Successful Basic IP to IP Call (End-to-End Precondition)

SIP-006140 [Figure 9.2-3](#), Successful Basic IP-to-IP Call (End-to-End Precondition), depicts the sequence of AS-SIP messages between the SC serving IP Party A and the SC serving IP Party B for establishing a telephony session, using a status-type end-to-end precondition.

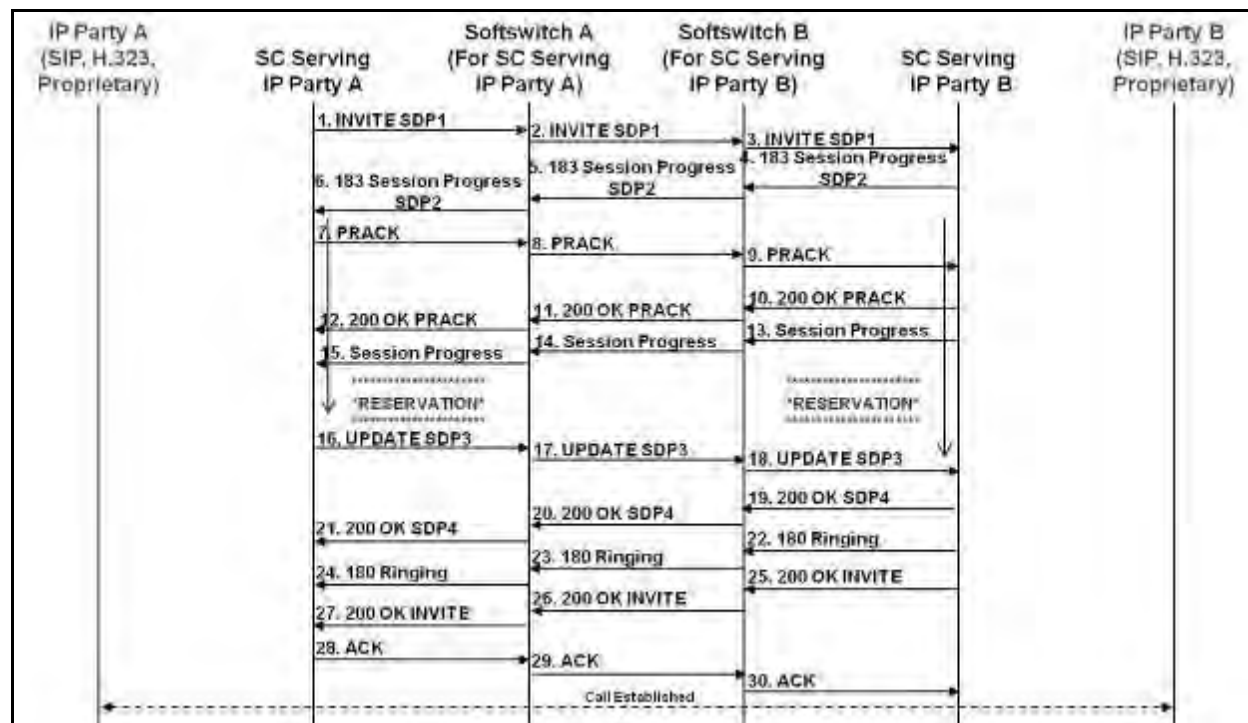

Figure 9.2-3. Successful Basic IP-to-IP Call (End-to-End Precondition)

Call Establishment

STEP	INSTRUCTION
1, 2, 3	Upon receiving an initial call request message from IP Party A (not depicted in the call flow diagram), the SC serving IP Party A sends an INVITE to its assigned SS (SS A). The INVITE contains an E2E precondition offer using SDP attributes described in RFC 3312. The precondition offer includes, at a minimum, a media (“m=”) line, a connection (“c=”) line, at least one current-status line, and at least one desired-status line. SS A forwards the INVITE to SS B that is assigned to the SC serving IP Party B. SS B forwards the INVITE to the SC serving IP Party B.
4, 5, 6	The SC serving IP Party B sends a 183 (Session Progress) response to SS B with an answer to the E2E precondition offer that includes, at a minimum, a media (“m=”) line, a connection (“c=”) line, at least one current-status line, at least one desired-status line, and at least one confirm-status line. SS B forwards the 183 (Session Progress) response to SS A, which forwards the 183 (Session Progress) response to the SC serving IP Party A. The SC serving IP Party A and IP Party B attempt to reserve the resources needed to fulfill the preconditions.
7, 8, 9	The SC serving IP Party A sends a PRACK to SS A. It forwards the PRACK to SS B, which forwards the PRACK to the SC serving IP Party B.
10, 11, 12	The SC serving IP Party B sends a 200 (OK) PRACK to SS B. It forwards the 200 (OK) PRACK to SS A, which forwards the 200 (OK) PRACK to the SC serving IP Party A.
13, 14, 15	The SC serving IP Party B sends a 183 (Session Progress) response with no sdp immediately after sending the 200 (OK) PRACK to notify the originating AS-SIP signaling appliance (i.e., SC serving IP Party A) that there is no early media and ringback must be generated locally.

STEP	INSTRUCTION
16, 17, 18	When the SC serving IP Party A receives confirmation that it has met its precondition (e.g., receives an RSVP RESV message), the SC serving IP Party A sends an UPDATE to SS A with an updated offer reflecting compliance with its part of the precondition. The updated precondition offer includes, at a minimum, a media (“m=”) line, a connection (“c=”) line, at least one current-status line, and at least one desired-status line. SS A forwards the UPDATE to SS B, which forwards the UPDATE to the SC serving IP Party B.
19, 20, 21	The SC serving IP Party B receives confirmation that it has met its precondition (e.g., receives RSVP RESV message) and sends a 200 (OK) UPDATE to SS B with an updated precondition answer reflecting compliance with its part of the precondition as well as the most recent updated information from the UPDATE offer. The updated answer includes, at a minimum, a media (“m=”) line, a connection (“c=”) line, at least one current-status line, and at least one desired-status line. SS B forwards the 200 (OK) UPDATE to SS A, which forwards the 200 (OK) UPDATE to the SC serving IP Party A.
22, 23, 24	The preconditions have been met so the SC serving IP Party B notifies the IP EI of a pending call and sends a 180 (Ringing) response to SS B. It forwards the 180 (Ringing) response to SS A, which forwards the 180 (Ringing) response to the SC serving IP Party A.
	NOTE: Signaling is not depicted between the SC serving IP Party B and the IP EI serving IP Party B. In addition, signaling is not depicted between the SC serving IP Party A and the EI serving Party A.
25, 26, 27	The SC serving IP Party B sends a 200 (OK) INVITE to SS B. It forwards the 200 (OK) INVITE to SS A, which forwards the 200 (OK) INVITE to the SC serving IP Party A.
	NOTE: Signaling is not depicted between the IP EI serving IP Party B and the SC serving IP Party B. In addition, signaling is not depicted between the SC serving IP Party A and the EI serving IP Party A.
28, 29, 30	The SC serving IP Party A sends an ACK to SS A. It sends the ACK to SS B, which forwards the ACK to the SC serving IP Party B.
	NOTE: Signaling is not depicted between the IP EI serving IP Party A and the SC serving IP Party A. In addition, signaling is not depicted between the SC serving IP Party B and the EI serving IP Party B.

9.2.1.3 Successful Basic IP to IP Call (Segmented Precondition)

SIP-006150 [Figure 9.2-4](#), Successful Basic IP-to-IP Call (Segmented Precondition), depicts the sequence of AS-SIP messages between the SC serving IP Party A and the SC serving IP Party B for establishing a telephony session, using a segmented precondition.



Figure 9.2-4. Successful Basic IP-to-IP Call (Segmented Precondition)

Call Establishment

STEP	INSTRUCTION
1, 2, 3	Upon receiving an initial call request message from IP Party A (not depicted in call flow diagram), the SC serving IP Party A satisfies its local precondition before sending an INVITE to its assigned SS (SS A). The INVITE contains a segmented precondition offer using SDP attributes described in RFC 3312. The precondition offer includes, at a minimum, a media (“m=”) line, a connection (“c=”) line, at least two current-status lines (local and remote), and at least two desired-status lines (local and remote). SS A forwards the INVITE to SS B, which is assigned to the SC serving IP Party B. SS B forwards the INVITE to the SC serving IP Party B.
4, 5, 6	The SC serving IP Party B sends a 183 (Session Progress) response with no sdp before sending the 180 (Ringing) response with the answer to the segmented precondition offer to notify the originating AS-SIP signaling appliance (i.e., SC serving IP Party A) that there is no early media and ringback must be generated locally.
7, 8, 9	The SC serving IP Party B satisfies its local precondition, notifies the IP EI of the pending call, and sends a 180 (Ringing) response with an answer to the segmented precondition offer that includes, at a minimum, a media (“m=”) line, a connection (“c=”) line, at least two current-status lines, and at least two desired-status lines to SS B. SS B forwards the 180 (Ringing) response to SS A, which forwards the 180 (Ringing) response to the SC serving IP Party A.
	NOTE: Signaling is not depicted between the SC serving IP Party B and the EI serving IP Party B. In addition, signaling is not depicted between the SC serving IP Party A and the EI serving Party A.
10, 11, 12	The SC serving IP Party A sends a PRACK to SS A. It forwards the PRACK to SS B, which forwards the PRACK to the SC serving IP Party B.

STEP	INSTRUCTION
13, 14, 15	The SC serving IP Party B sends a 200 (OK) PRACK to SS B. It forwards the 200 (OK) PRACK response to SS A, which forwards the 200 (OK) PRACK to the SC serving IP Party A.
16, 17, 18	The SC serving IP Party B sends a 200 (OK) INVITE to SS B. It forwards the 200 (OK) INVITE to SS A, which forwards the 200 (OK) INVITE to the SC serving IP Party A.
	NOTE: Signaling is not depicted between the IP EI serving IP Party B and the SC serving IP Party B. In addition, signaling is not depicted between the SC serving IP Party A and the EI serving IP Party A.
19, 20, 21	The SC serving IP Party A sends an ACK to SS A. It forwards the ACK to SS B, which forwards the ACK to the SC serving IP Party B.
	NOTE: Signaling is not depicted between the IP EI serving IP Party A and the SC serving IP Party A. In addition, signaling is not depicted between the SC serving IP Party B and the EI serving IP Party B.

9.3 CALL HOLD

Party A and Party B are engaged in a conversation. Party A places the call on hold. Later, Party A resumes the call (i.e., removes the call from hold).

9.3.1 IP-to-IP Call Type

SIP-006160 [Figure 9.3-1](#), IP-to-IP Call Hold, depicts the sequence of AS-SIP messages between the SC serving IP Party A and the SC serving IP Party B that are used to place the current call on hold, and then to resume the call.

When the call is on hold, the re-INVITE that initiates the call resume (steps 10-12 in [Figure 9.3-1](#) and [Figure 9.3-2](#)) can be implemented using populated INVITEs or unpopulated INVITEs. The use of a populated INVITE for the call resume is depicted in [Figure 9.3-1](#), IP-to-IP Call on Hold (All Populated INVITEs). The use of an unpopulated INVITE for the call resume is depicted in [Figure 9.3-2](#), IP-to-IP Call Hold (Unpopulated Resume INVITE).

NOTE: The sequence of messages is identical in both figures but the location of the sdp offers and sdp answers varies.



Figure 9.3-1. IP-to-IP Call Hold (All Populated INVITES)

Call Hold

STEP	INSTRUCTION
1, 2, 3	In response to a request on the part of IP Party A, the SC serving IP Party A sends a mid-call INVITE with a sdp offer to SS A. The INVITE sdp includes the attribute line “a=sendonly” if the stream had been a sendrecv media stream, or “a=inactive” if the stream had been a recvonly stream. SS A forwards the mid-call INVITE to SS B, which is assigned to the SC serving IP Party B. SS B forwards the mid-call INVITE to the SC serving IP Party B.
	NOTE: The SIP UA MAY also support establishing a call hold by sending a mid-call INVITE that includes a session description, which is the same as in the original request, but the “c” destination addresses for the media streams to be put on hold are set to zero: c=IN IP4 0.0.0.0.
	NOTE: Signaling is not depicted between the EI serving IP Party A and the SC serving IP Party A. In addition, signaling is not depicted between the SC serving IP Party B and the EI serving IP Party B.
4, 5, 6	The SC serving IP Party B sends a 200 (OK) response with the sdp answer to SS B. SS B forwards the 200 (OK) response to SS A, which forwards the 200 (OK) response to the SC serving IP Party A.
	If the sdp offer included the attribute line “a=sendonly,” then the sdp answer in the 200 (OK) response is either “a=recvonly” or “a=inactive.” If the sdp answer in the 200 (OK) response is not “a=recvonly” or “a=inactive” then the SC serving IP Party A will accept the response and continue normal processing of the call hold.
	If the sdp offer included the attribute line “a=inactive,” then the sdp answer in the 200 (OK) response MUST be “a=inactive.” If the sdp answer in the 200 (OK) response is not “a=inactive” then the SC serving IP Party A will accept the response and continue normal processing of the call hold.

STEP	INSTRUCTION
	NOTE: Signaling is not depicted between the EI serving IP Party B and the SC serving IP Party B. In addition, signaling is not depicted between the SC serving IP Party A and the EI serving IP Party A.
7, 8, 9	The SC serving IP Party A sends an ACK to SS A. It forwards the ACK to SS B, which forwards the ACK to the SC serving IP Party B.
	NOTE: Signaling is not depicted between the SC serving IP Party B and the EI serving IP Party B.

The call is on hold now.

Call Resume

STEP	INSTRUCTION
10, 11, 12	In response to a request on the part of IP Party A, the SC serving IP Party A sends a mid-call re-INVITE with a sdp offer to SS A. It forwards the mid-call re-INVITE to SS B, which forwards the mid-call re-INVITE to the SC serving IP Party B. The re INVITE includes the attribute line “a=sendrecv” if the stream had originally been a sendrecv media stream, or “a=recvonly” if the stream had been a recvonly stream.
	NOTE: In the case of a call hold established by setting the “c” destination address to 0.0.0.0, another re-INVITE with the original address parameter terminates the call hold.
	NOTE: Signaling is not depicted between the EI serving IP Party A and the SC serving IP Party A. In addition, signaling is not depicted between the SC serving IP Party B and the EI serving IP Party B.
13, 14, 15	The SC serving IP Party B sends a 200 (OK) response with the sdp answer to SS B. It forwards the 200 (OK) response to SS A, which forwards the 200 (OK) response to the SC serving IP Party A. If the sdp offer received in Step 12 included the attribute ‘a=sendrecv’ then to resume a ‘two way’ call the sdp answer will respond with the attribute “a=sendrecv.” If the sdp offer received in Step 12 included the attribute “a=recvonly” then to resume the call the sdp answer will respond with the attribute “a=sendonly.”
	NOTE: Signaling is not depicted between the EI serving IP Party B and the SC serving IP Party B. In addition, signaling is not depicted between the SC serving IP Party A and the EI serving IP Party A.
16, 17, 18	The SC serving IP Party A sends an ACK to SS A. It forwards the ACK to SS B, which forwards the ACK to the SC serving IP Party B.
	NOTE: Signaling is not depicted between the EI serving IP Party A and the SC serving IP Party A. In addition, signaling is not depicted between the SC serving IP Party B and the EI serving IP Party B.

The call is resumed now.

The use of a combination of a populated INVITE for call hold and an empty INVITE for call resume is depicted in [Figure 9.3-2](#), IP-to-IP Call Hold (Unpopulated Resume INVITE).

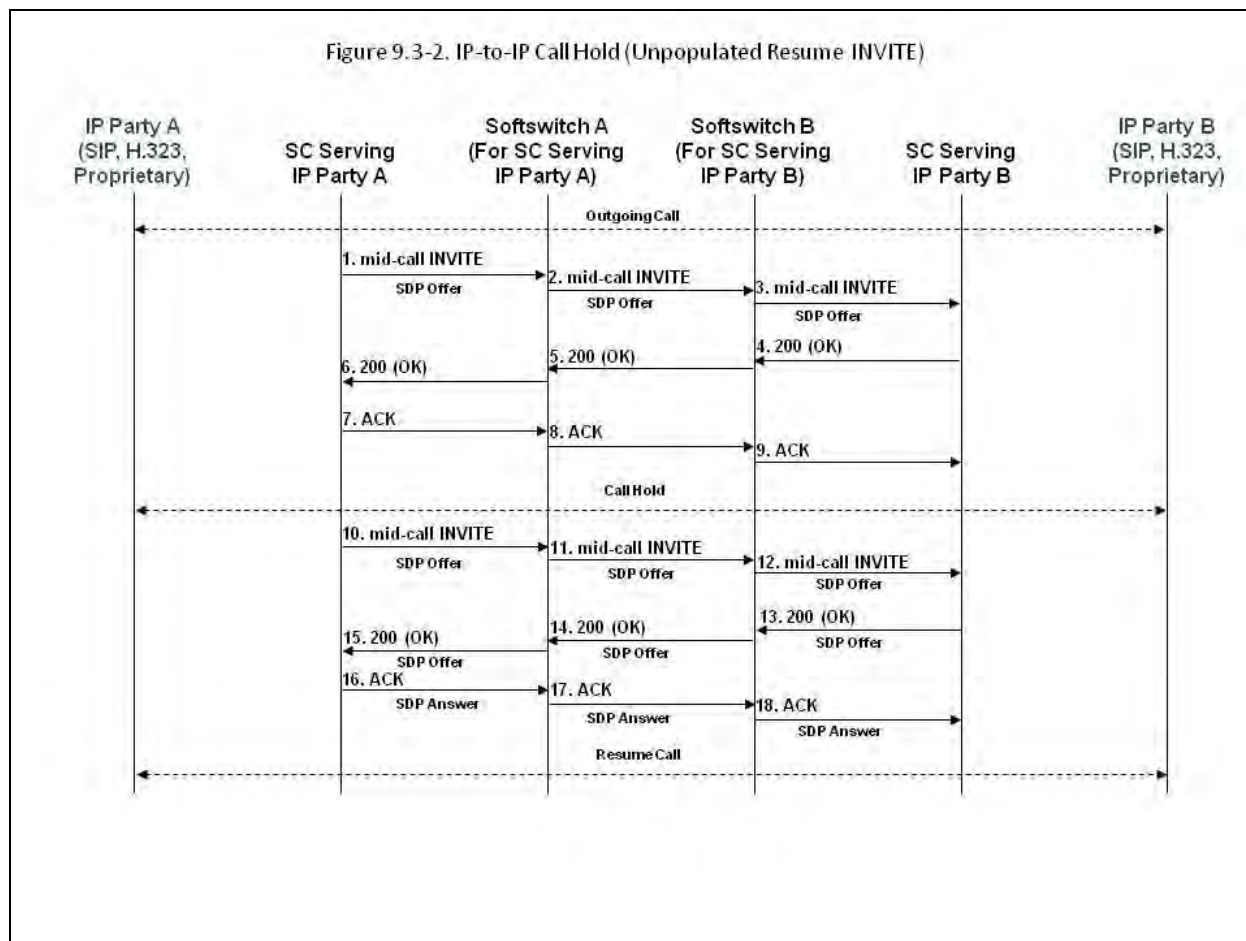

Figure 9.3-2. IP-to-IP Call Hold (Unpopulated Resume INVITE)

Call Hold

STEP	INSTRUCTION
1, 2, 3	In response to a request on the part of IP Party A, the SC serving IP Party A sends a mid-call INVITE with a sdp offer to SS A. The INVITE sdp includes the attribute line “a=sendonly” if the stream had been a sendrecv media stream, or “a=inactive” if the stream had been a recvonly stream. SS A forwards the mid-call INVITE to SS B, which is assigned to the SC serving IP Party B. SS B forwards the mid-call INVITE to the SC serving IP Party B.
	NOTE: The SIP UA MAY also support establishing a call hold by sending a mid-call INVITE that includes a session description, which is the same as in the original request, but the “c” destination addresses for the media streams to be put on hold are set to zero: c=IN IP4 0.0.0.0.
	NOTE: Signaling is not depicted between the EI serving IP Party A and the SC serving IP Party A. In addition, signaling is not depicted between the SC serving IP Party B and the EI serving IP Party B.
4, 5, 6	The SC serving IP Party B sends a 200 (OK) response with the sdp answer to SS B. SS B forwards the 200 (OK) response to SS A, which forwards the 200 (OK) response to the SC serving IP Party A.

STEP	INSTRUCTION
	If the sdp offer included the attribute line “a=sendonly,” then the sdp answer in the 200 (OK) response is either “a=recvonly” or “a=inactive.” If the sdp answer in the 200 (OK) response is not “a=recvonly” or “a=inactive” then the SC serving IP Party A will accept the response and continue normal processing of the call hold.
	If the sdp offer included the attribute line “a=inactive,” then the sdp answer in the 200 (OK) response MUST be “a=inactive.” If the sdp answer in the 200 (OK) response is not “a=inactive” then the SC serving IP Party A will accept the response and continue normal processing of the call hold.
	NOTE: Signaling is not depicted between the EI serving IP Party B and the SC serving IP Party B. In addition, signaling is not depicted between the SC serving IP Party A and the EI serving IP Party A.
7, 8, 9	The SC serving IP Party A sends an ACK to SS A. It forwards the ACK to SS B, which forwards the ACK to the SC serving IP Party B.
	NOTE: Signaling is not depicted between the SC serving IP Party B and the EI serving IP Party B.

The call is on hold now.

Call Resume

STEP	INSTRUCTION
10, 11, 12	In response to a request on the part of IP Party A, the SC serving Party A sends an unpopulated mid-call re-INVITE to SS A (i.e., the mid-call re-INVITE does not have a SDP offer). SS A forwards the mid-call re-INVITE to SS B, which forwards the mid-call re-INVITE to the SC serving IP Party B.
	NOTE: Signaling is not depicted between the EI serving IP Party A and the SC serving IP Party A. In addition, signaling is not depicted between the SC serving IP Party B and the EI serving IP Party B.
13, 14, 15	The SC serving IP Party B sends a 200 (OK) response with a sdp offer to SS B. The sdp offer must include an audio media description offering the required audio codecs and MUST NOT have the attribute a=inactive. [To resume a “2-way” call the sdp offer will include the attribute a=sendrecv”] SS B forwards the 200 (OK) response to SS A, which forwards the 200 (OK) response to the SC serving IP Party A.
	NOTE: Signaling is not depicted between the EI serving IP Party B and the SC serving IP Party B. In addition, signaling is not depicted between the SC serving IP Party A and the EI serving IP Party A.
16, 17, 18	The SC serving IP Party A sends an ACK with the sdp answer to SS A. SS A forwards the ACK to SS B, which forwards the ACK to the SC serving IP Party B.
	If the sdp offer received in Step 15 included the attribute “a=sendrecv” then in order to resume a “2-way” call the sdp answer in Step 16 MUST include the attribute “a=sendrecv.”
	NOTE: Signaling is not depicted between the EI serving IP Party A and the SC serving IP Party A. In addition, signaling is not depicted between the SC serving IP Party B and the EI serving IP Party B.

The call is resumed now.

9.3.1.1 Successful Basic IP-to-IP Call Hold (AS-SIP EI)

Figure 9.3-3, IP-to-IP Call Hold (AS-SIP EIs), shows that AS-SIP EI A sends a mid-call INVITE (Step 1). The INVITE sdp body includes the attribute line “a=sendonly” if the stream had been a sendrecv media stream, or “a=inactive” if the stream had been a recvonly stream. AS-SIP EI B receives the INVITE (Step 5), responds with a 200 (OK) response (Step 6), and stops sending and receiving/processing the media stream. The 200 (OK) response includes an sdp answer where:

- If the sdp offer in Step 5 included the attribute line “a=sendonly,” then the sdp answer in the 200 (OK) response is either “a=recvonly” or “a=inactive.”
- If the sdp offer in Step 5 included the attribute line “a=inactive,” then the sdp answer in the 200 (OK) response MUST be “a=inactive.”

AS-SIP EI A receives the 200 (OK) response (Step 10). If the sdp offer in Step 1 had been a=sendonly and the sdp answer in the 200 (OK) response is an attribute other than “a=recvonly” (i.e., “a=sendrecv” or “a=sendonly” or “a=inactive”), then AS-SIP EI A MUST accept the response and continue normal processing of the call hold. If the sdp offer in Step 1 had been a=inactive and the sdp answer in the 200 (OK) had been an attribute other than “a=inactive” (i.e., “a=sendrecv” or “a=recvonly” or “a=sendonly”), then AS-SIP EI A MUST accept the response and continue normal processing of the call hold.



Figure 9.3-3. IP-to-IP Call Hold (AS-SIP EIs)

AS-SIP EI A stops sending and receiving or processing the media stream. AS-SIP EI A sends an ACK (Step 11). AS-SIP EI B receives the ACK (Step 15). The call is now on hold.

When the user at AS-SIP EI A is ready to resume the call that is on hold, then AS-SIP EI A sends a mid-call INVITE (Step 16) that includes the attribute line “a=sendrecv” if the stream had originally been a sendrecv media stream, or “a=recvonly” if the stream had been a recvonly stream. AS-SIP EI B receives the mid-call INVITE (Step 20). AS-SIP EI B sends a 200 (OK) response (Step 21). The 200 (OK) response includes an sdp answer where:

- If the sdp offer in Step 20 included the attribute line “a=sendonly,” then the sdp answer in the 200 (OK) response is “a=recvonly.” AS-SIP EI B resumes receiving or processing the media stream.
- If the sdp offer in Step 20 included the attribute line “a=sendrecv” then in order to resume a “2-way” call the sdp answer in the 200 (OK) response needs to be “a=sendrecv.” AS-SIP EI B resumes sending and receiving or processing the media stream.

AS-SIP EI A receives the 200 (OK) response (Step 25). If the sdp answer has the attribute “a=recvonly,” then AS-SIP EI A will send but not receive packets on the media stream; if the attribute is “a=sendrecv,” then AS-SIP EI A will send and receive packets on the media stream. The AS-SIP EI A sends an ACK (Step 26). AS-SIP EI B receives the ACK (Step 30).

Unpopulated INVITE notes: When the SC serving AS-SIP EI A is implemented as a B2BUA and receives the populated INVITE at Step 16, the SC MAY forward an unpopulated INVITE toward AS-SIP EI B. If this occurs then when AS-SIP EI B receives the unpopulated INVITE, AS-SIP EI B will respond by generating a 200 OK with a sdp offer. In order to resume a “2-way” call the sdp offer MUST have an audio media description that offers the required audio codecs and cannot have any direction attribute other than “a=sendrecv.” At Step 26 AS-SIP EI A will need to respond with an ACK having a sdp answer that also includes the attribute “a=sendrecv” in order to resume a “2-way” call.

9.3.2 [Conditional] Music on Hold

SIP-006170 Music on hold is a conditional requirement. The requirements set forth in [Section 9.3.2.1](#), IP-to-IP Call Type, are conditional.

Party A and Party B are engaged in a conversation. Party A places the call on hold, and then connects Party B to the media server to enable Party B to hear music while on hold. Later, Party A removes the connection to the media server and places the call back on hold without music, and then removes the hold altogether and resumes the call.

9.3.2.1 IP-to-IP Call Type

SIP-006180 Music on hold can be implemented by using populated INVITES or by using a combination of populated INVITES and unpopulated INVITES. The use of populated INVITES (only) is depicted in [Figure 9.3-4](#), IP-to-IP Music on Hold (Populated INVITES). The use of populated INVITES and unpopulated INVITES is depicted in [Figure 9.3-5](#), IP-to-IP Music on Hold (Populated INVITES and Empty INVITES).

NOTE: The sequence of messages is identical in both figures but the location of the sdp offers and sdp answers varies.

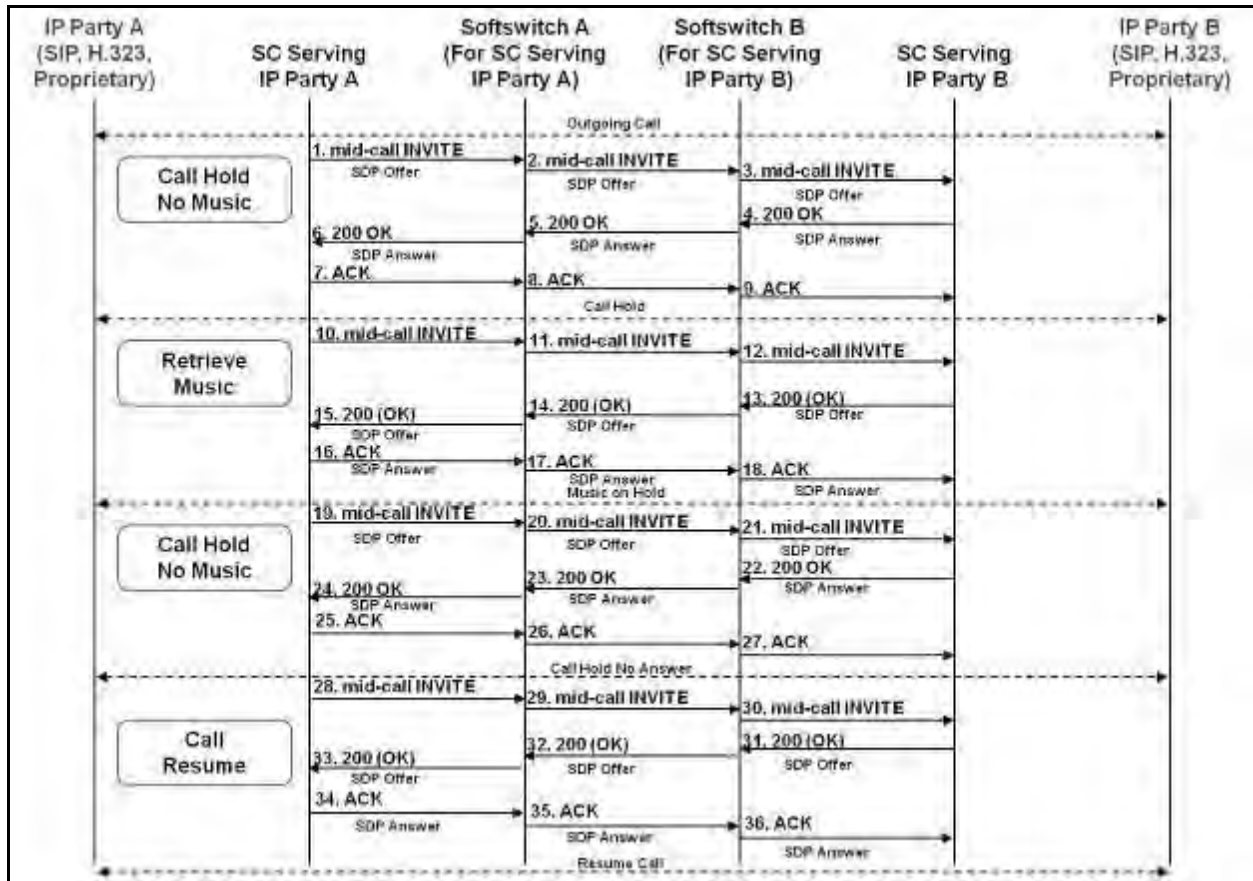

Figure 9.3-4. IP-to-IP Music on Hold (Populated INVITEs)

Call Hold

STEP	INSTRUCTION
1, 2, 3	In response to a request on the part of Party A, the SC serving IP Party A sends a mid-call INVITE with a sdp offer to SS A. The INVITE sdp includes the attribute line “a=sendonly” if the stream had been a sendrecv media stream, or “a=inactive” if the stream had been a recvonly stream. SS A forwards the mid-call INVITE to SS B, which is assigned to the SC serving IP Party B. SS B forwards the mid-call INVITE to the SC serving IP Party B.
	NOTE: The SIP UA also MAY support establishing a call hold by sending a mid-call INVITE that includes a session description, which is the same as in the original request, but the “c” destination addresses for the media streams to be put on hold are set to zero: c=IN IP4 0.0.0.0. It is also permissible to set the media streams to zero simultaneously: c=IN IP4 0.0.0.0 and include the attribute a=inactive.
	NOTE: Signaling is not depicted between the EI serving IP Party A and the SC serving IP Party A. In addition, signaling is not depicted between the SC serving IP Party B and the EI serving IP Party B.

STEP	INSTRUCTION
4, 5, 6	The SC serving IP Party B sends a 200 (OK) response with the sdp answer to SS B. SS B forwards the 200 (OK) response to SS A, which forwards the 200 (OK) response to the SC serving IP Party A.
	If the sdp offer included the attribute line “a=sendonly,” then the sdp answer in the 200 (OK) response MUST be either “a=recvonly” or “a=inactive.” If the sdp answer in the 200 (OK) response is not “a=recvonly” or “a=inactive” then the SC serving IP Party A will accept the response and continue normal processing of the call hold.
	If the sdp offer included the attribute line “a=inactive,” then the sdp answer in the 200 (OK) response MUST be “a=inactive.” If the sdp answer in the 200 (OK) response is not “a=inactive” then the SC serving IP Party A will accept the response and continue normal processing of the call hold.
	NOTE: Signaling is not depicted between the EI serving IP Party B and the SC serving IP Party B is not depicted. In addition, signaling is not depicted between the SC serving IP Party A and the EI serving IP Party A.
7, 8, 9	The SC serving IP Party A sends an ACK to SS A. It forwards the ACK to SS B, which forwards the ACK to the SC serving IP Party B.
	NOTE: Signaling is not depicted between the SC serving IP Party B and the EI serving IP Party B.

The call is now on hold but with no music being played.

STEP	INSTRUCTION
10, 11, 12	The SC serving IP Party A sends a mid-call re-INVITE with a sdp offer to SS A. SS A forwards the mid-call re-INVITE to SS B, which forwards the mid-call re-INVITE to the SC serving IP Party B. The re INVITE includes a connection information “c=” line having the IP address of the media server that will be playing the music and the m=audio line can have a different udp port, can offer a modified set of codecs (although G.711 must be offered), and includes the “a=sendonly” attribute line.
	NOTE: If the session on hold had been a video session, then the SDP offer in the INVITE sent by the SC serving IP Party A MUST continue to include a “hold” of the video media. The video media description offering the “hold” can use one of the three following formats: (a) specify a valid port number (other than zero) and include the attribute line a=inactive or (b) include a “c=” line set to zero for the video stream: c=IN IP4 0.0.0.0 or (c) include a “c=” line set to zero for the video stream: c=IN IP4 0.0.0.0 and include the attribute line a=inactive
	NOTE: Signaling is not depicted between the SC serving IP Party B and the EI serving IP Party B.
13, 14, 15	The SC serving IP Party B sends a 200 (OK) response with the sdp answer to SS B. SS B forwards the 200 (OK) response to SS A, which forwards the 200 (OK) response to the SC serving IP Party A. The audio media description in the sdp answer must have the “a=recvonly” attribute in order for Party B to hear the music on hold.
	NOTE: If the session on hold had been a video session, then the SDP answer in the 200 (OK) response sent by the SC serving IP Party B MUST respond to the sdp offer of a “Held” video stream by including a corresponding video media description using one of the three following formats: (a) specify a valid port number (other than zero) and include the attribute line a=inactive or (b) include a “c=” line set to zero for the video stream: c=IN IP4 0.0.0.0 or (c) include a “c=” line set to zero for the video stream: c=IN IP4 0.0.0.0 and include the attribute line a=inactive
	NOTE: Signaling is not depicted between the EI serving IP Party B and the SC serving IP Party B.

STEP	INSTRUCTION
16, 17, 18	The SC serving IP Party A sends an ACK to SS A. It forwards the ACK to SS B, which forwards the ACK to the SC serving IP Party B.
	NOTE: Signaling is not depicted between the SC serving IP Party B and the EI serving IP Party B.

The call is on Music on Hold now. Music is streaming from the media server associated with SC A to IP Party B.

Call Resume

STEP	INSTRUCTION
19, 20, 21	In response to a request on the part of IP Party A, the SC serving IP Party A sends a mid-call re-INVITE with a sdp offer to SS A. SS A forwards the mid-call re-INVITE to SS B, which forwards the mid-call re-INVITE to the SC serving IP Party B. The re-INVITE sdp includes the attribute line “a=sendonly” if the stream had been a sendrecv media stream, or “a=inactive” if the stream had been a recvonly stream.
	The re INVITE includes a connection information “c=” line having the IP address of IP Party A unless SC A sets the “c” destination address to 0.0.0.0 per RFC 2543.
	NOTE: Signaling is not depicted between the EI serving IP Party A and the SC serving IP Party A. In addition, signaling is not depicted between the SC serving IP Party B and the EI serving IP Party B.
	This re-INVITE transaction is intended to remove the media server from the bearer path and to return the call state to a call hold without music.
22, 23, 24	The SC serving IP Party B sends a 200 (OK) response with a sdp answer to SS B. SS B forwards the 200 (OK) response to SS A, which forwards the 200 (OK) response to the SC serving IP Party A.
	If the sdp offer included the attribute line “a=sendonly,” then the sdp answer in the 200 (OK) response MUST be either “a=recvonly” or “a=inactive.” If the sdp answer in the 200 (OK) response is “a=recvonly” or “a=inactive” then the SC serving IP Party A will accept the response and continue normal processing of the call hold.
	If the sdp offer included the attribute line “a=inactive,” then the sdp answer in the 200 (OK) response MUST be “a=inactive.” If the sdp answer in the 200 (OK) response is not “a=inactive” then the SC serving IP Party A will accept the response and continue normal processing of the call hold.
	NOTE: Signaling is not depicted between the EI serving IP Party B and the SC serving IP Party B. In addition, signaling is not depicted between the SC serving IP Party A and the EI serving IP Party A.
25, 26, 27	The SC serving IP Party A sends an ACK to SS A. It forwards the ACK to SS B, which forwards the ACK to the SC serving IP Party B.
	NOTE: Signaling is not depicted between the SC serving IP Party B and the EI serving IP Party B.
28, 29, 30	The SC serving IP Party A sends a mid-call re-INVITE with a sdp offer to SS A. SS A forwards the mid-call re-INVITE to SS B, which forwards the mid-call re-INVITE to the SC serving IP Party B. The re INVITE sdp includes the attribute line “a=sendrecv” if the stream originally had been a sendrecv media stream, or “a=recvonly” if the stream had been a recvonly stream.
	NOTE: In the case of a call hold established by setting the “c” destination address to 0.0.0.0, the re-INVITE includes the original address parameter.
	NOTE: Signaling is not depicted between the SC serving IP Party B and the EI serving IP Party B.

STEP	INSTRUCTION
31, 32, 33	The SC serving IP Party B sends a 200 (OK) response with the sdp answer to SS B. SS B forwards the 200 (OK) response to SS A, which forwards the 200 (OK) response to the SC serving IP Party A.
	If the sdp offer had the attribute "a=sendrecv," then in order to resume a "2-way" call the sdp answer MUST use the attribute "a=sendrecv."
	If the sdp offer had the attribute "a=recvonly," then the sdp answer MUST use the attribute "a=sendonly" to resume the previous '1-way' call.
	NOTE: Signaling is not depicted between the EI serving IP Party B and the SC serving IP Party B. In addition, signaling is not depicted between the SC serving IP Party A and the EI serving IP Party A.
34, 35, 36	The SC serving IP Party A sends an ACK to SS A. It forwards the ACK to SS B, which forwards the ACK to the SC serving IP Party B.
	NOTE: Signaling is not depicted between the EI serving IP Party A and the SC serving IP Party A. In addition, signaling is not depicted between the SC serving IP Party B and the EI serving IP Party B.

The call is resumed now.

The use of a combination of populated INVITES and empty INVITES is depicted in [Figure 9.3-5](#), IP-to-IP Music on Hold (Populated INVITES and Empty INVITES).

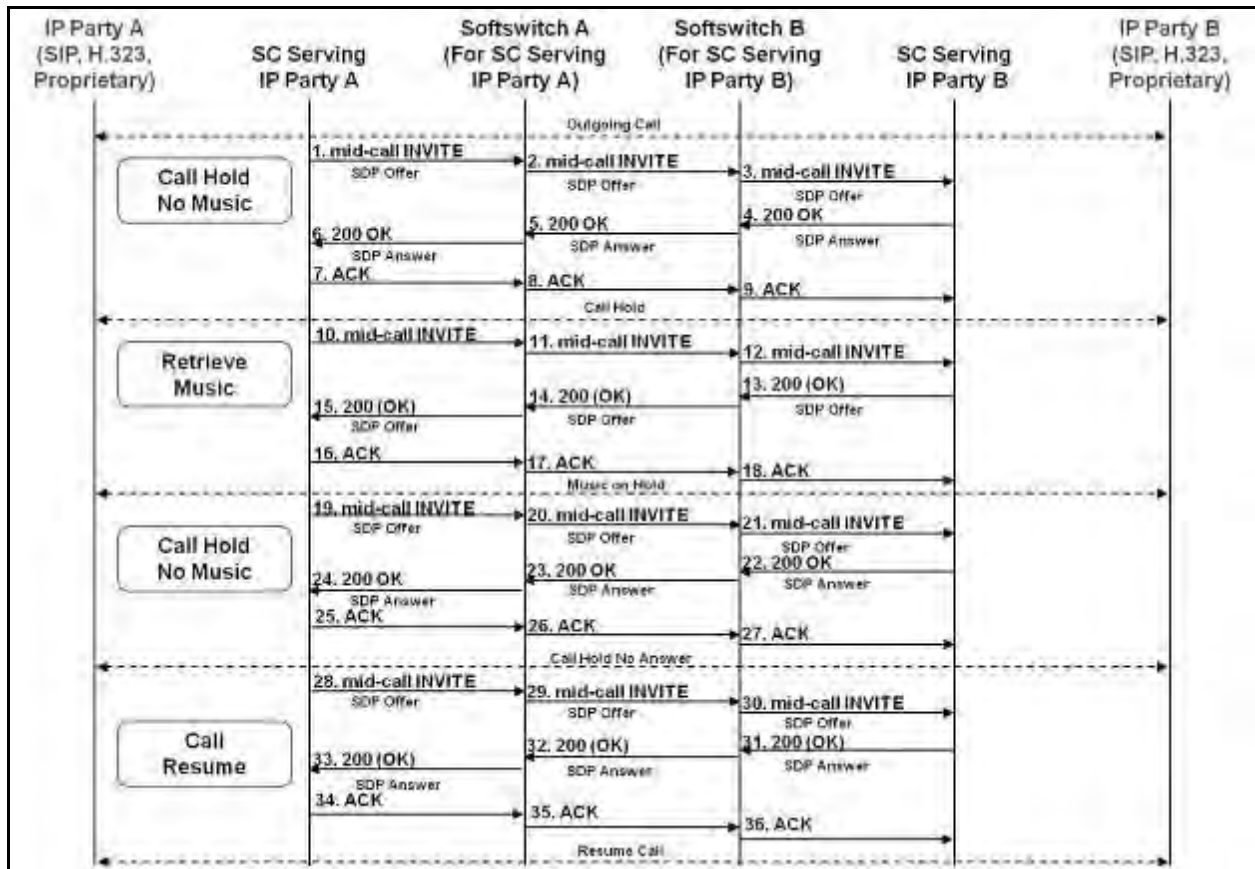

Figure 9.3-5. IP-to-IP Music on Hold (Populated INVITES and Empty INVITES)

Call Hold

STEP	INSTRUCTION
1, 2, 3	In response to a request on the part of Party A, the SC serving IP Party A sends a mid-call INVITE with a sdp offer to SS A. The INVITE includes the attribute line “a=sendonly” if the stream had been a sendrecv media stream, or “a=inactive” if the stream had been a recvonly stream. SS A forwards the mid-call INVITE to SS B, which is assigned to the SC serving IP Party B. SS B forwards the mid-call INVITE to the SC serving IP Party B.
	NOTE: The SIP UA also MAY support establishing a call hold by sending a mid-call INVITE that includes a session description, which is the same as in the original request, but the “c” destination addresses for the media streams to be put on hold are set to zero: c=IN IP4 0.0.0.0. It is also permissible to set the media streams to zero simultaneously: c=IN IP4 0.0.0.0 and include the attribute a=inactive. NOTE: Signaling is not depicted between the EI serving IP Party A and the SC serving IP Party A. In addition, signaling is not depicted between the SC serving IP Party B and the EI serving IP Party B.
4, 5, 6	The SC serving IP Party B sends a 200 (OK) response with the sdp answer to SS B. SS B forwards the 200 (OK) response to SS A, which forwards the 200 (OK) response to the SC serving IP Party A.
	If the sdp offer included the attribute line “a=sendonly,” then the sdp answer in the 200 (OK) response MUST be either “a=recvonly” or “a=inactive.” If the sdp answer in the 200 (OK) response is not “a=recvonly” or “a=inactive” then the SC serving IP Party A will accept the response and continue normal processing of the call hold.
	If the sdp offer included the attribute line “a=inactive,” then the sdp answer in the 200 (OK) response MUST be “a=inactive.” If the sdp answer in the 200 (OK) response is not “a=inactive” then the SC serving IP Party A will accept the response and continue normal processing of the call hold.
	NOTE: Signaling is not depicted between the EI serving IP Party B and the SC serving IP Party B. In addition, signaling is not depicted between the SC serving IP Party A and the EI serving IP Party A.
7, 8, 9	The SC serving IP Party A sends an ACK to SS A. It forwards the ACK to SS B, which forwards the ACK to the SC serving IP Party B.
	NOTE: Signaling is not depicted between the SC serving IP Party B and the EI serving IP Party B.

The call is now on hold but with no music being played.

STEP	INSTRUCTION
10, 11, 12	The SC serving IP Party A sends a mid-call empty re-INVITE (i.e., no sdp offer) to SS A. SS A forwards the mid-call re-INVITE to SS B, which forwards the mid-call re-INVITE to the SC serving IP Party B.
	NOTE: Signaling is not depicted between the SC serving IP Party B and the EI serving IP Party B.
13, 14, 15	The SC serving IP Party B sends a 200 (OK) response with an sdp offer to SS B. SS B forwards the 200 (OK) response to SS A, which forwards the 200 (OK) responses to the SC serving IP Party A. The sdp offer must have an audio media description that includes either the “a=sendrecv” attribute or the “a=recvonly” attribute in order for Party B to hear the music on hold.

STEP	INSTRUCTION
	<p>NOTE: If the session on hold had been a video session, then the SDP offer in the 200 (OK) response sent by the SC serving IP Party B MUST continue to include a “hold” of the video media. The video media description offering the “hold” can use one of the following three formats:</p> <ul style="list-style-type: none"> (a) specify a valid port number (other than zero) and include the attribute line a=inactive or (b) include a “c=” line set to zero for the video stream: c=IN IP4 0.0.0.0 or (c) include a “c=” line set to zero for the video stream: c=IN IP4 0.0.0.0 and include the attribute line a=inactive
	<p>NOTE: Signaling is not depicted between the EI serving IP Party B and the SC serving IP Party B.</p>
16, 17, 18	<p>The SC serving IP Party A sends an ACK with the sdp answer to SS A. SS A forwards the ACK to SS B, which forwards the ACK to the SC serving IP Party B.</p>
	<p>The sdp answer includes a connection information “c=” line having the IP address of the media server that will be playing the music and includes the “a=sendonly” attribute in the audio media description.</p>
	<p>NOTE: If the session on hold had been a video session, then the SDP answer in the ACK sent by the SC serving IP Party A MUST respond to the sdp offer of a “Held” video stream by including a corresponding video media description using one of the following three formats:</p> <ul style="list-style-type: none"> (a) specify a valid port number (other than zero) and include the attribute line a=inactive or (b) include a “c=” line set to zero for the video stream: c=IN IP4 0.0.0.0 or (c) include a “c=” line set to zero for the video stream: c=IN IP4 0.0.0.0 and include the attribute line a=inactive.
	<p>NOTE: Signaling is not depicted between the SC serving IP Party B and the EI serving IP Party B.</p>

The call is on Music on Hold now. Music is streaming from the media server associated with SC A to IP Party B.

Call Resume

STEP	INSTRUCTION
19, 20, 21	<p>In response to a request on the part of IP Party A, the SC serving IP Party A sends a mid-call re-INVITE to SS A. SS A forwards the mid-call re-INVITE to SS B, which forwards the mid-call re-INVITE to the SC serving IP Party B. The re INVITE includes the attribute line “a=sendonly” if the stream had been a sendrecv media stream, or “a=inactive” if the stream had been a recvonly stream.</p>
	<p>The re INVITE includes a connection information “c=” line having the IP address of IP Party A unless SC A sets the “c” destination address to 0.0.0.0 per RFC 2543.</p>
	<p>NOTE: Signaling is not depicted between the EI serving IP Party A and the SC serving IP Party A. In addition, signaling is not depicted between the SC serving IP Party B and the EI serving IP Party B.</p>
	<p>This re-INVITE transaction is intended to remove the media server from the bearer path and to return the call state to a call hold without music.</p>
22, 23, 24	<p>The SC serving IP Party B sends a 200 (OK) response with the SDP answer to SS B. SS B forwards the 200 (OK) response to SS A, which forwards the 200 (OK) response to the SC serving IP Party A.</p>
	<p>If the sdp offer included the attribute line “a=sendonly,” then the sdp answer in the 200 (OK) response MUST be either “a=recvonly” or “a=inactive.” If the sdp answer in the 200 (OK) response is not “a=recvonly” or “a=inactive” then the SC serving IP Party A will accept the response and continue normal processing of the call hold.</p>

STEP	INSTRUCTION
	If the sdp offer included the attribute line “a=inactive,” then the sdp answer in the 200 (OK) response MUST be “a=inactive.” If the sdp answer in the 200 (OK) response is not “a=inactive” then the SC serving IP Party A will accept the response and continue normal processing of the call hold.
	NOTE: Signaling is not depicted between the EI serving IP Party B and the SC serving IP Party B. In addition, signaling is not depicted between the SC serving IP Party A and the EI serving IP Party A.
25, 26, 27	The SC serving IP Party A sends an ACK to SS A. It forwards the ACK to SS B, which forwards the ACK to the SC serving IP Party B.
	NOTE: Signaling is not depicted between the SC serving IP Party B and the EI serving IP Party B.
28, 29, 30	The SC serving IP Party A sends a mid-call empty re-INVITE (i.e., no sdp offer) to SS A. SS A forwards the mid-call re-INVITE to SS B, which forwards the mid-call re-INVITE to the SC serving IP Party B.
	NOTE: Signaling is not depicted between the SC serving IP Party B and the EI serving IP Party B.
31, 32, 33	The SC serving IP Party B sends a 200 (OK) response with an sdp offer to SS B. SS B forwards the 200 (OK) response to SS A, which forwards the 200 (OK) response to the SC serving IP Party A.
	The sdp offer must include an audio media description offering the required codecs and MUST NOT have the attribute “a=inactive.” [To resume a “2-way” call the sdp offer MUST include the attribute a=sendrecv”]
	NOTE: Signaling is not depicted between the EI serving IP Party B and the SC serving IP Party B. In addition, signaling is not depicted between the SC serving IP Party A and the EI serving IP Party A.
34, 35, 36	The SC serving IP Party A sends an ACK with the sdp answer to SS A. SS A forwards the ACK to SS B, which forwards the ACK to the SC serving IP Party B.
	If the sdp offer received in Step 33 was “a=sendrecv,” then in order to resume a “2-way” call the sdp answer in Step 34 MUST include the attribute “a=sendrecv.”
	NOTE: Signaling is not depicted between the EI serving IP Party A and the SC serving IP Party A. In addition, signaling is not depicted between the SC serving IP Party B and the EI serving IP Party B.

The call is resumed now.

9.3.2.1.1 Successful Basic IP-to-IP Music on Hold (AS-SIP EI)

[Figure 9.3-6](#), IP-to-IP Music on Hold (AS-SIP EIs), shows that AS-SIP EI A sends a mid-call INVITE (Step 1). The INVITE sdp body includes the attribute line “a=inactive” and/or by setting the connection address to 0.0.0.0.

NOTE: If an SC receives a re-INVITE from a served AS-SIP EI whose sdp body has “a=sendonly”, the SC MUST NOT conduct Music on Hold because the SC cannot be certain that the AS-SIP EI is initiating a call hold.

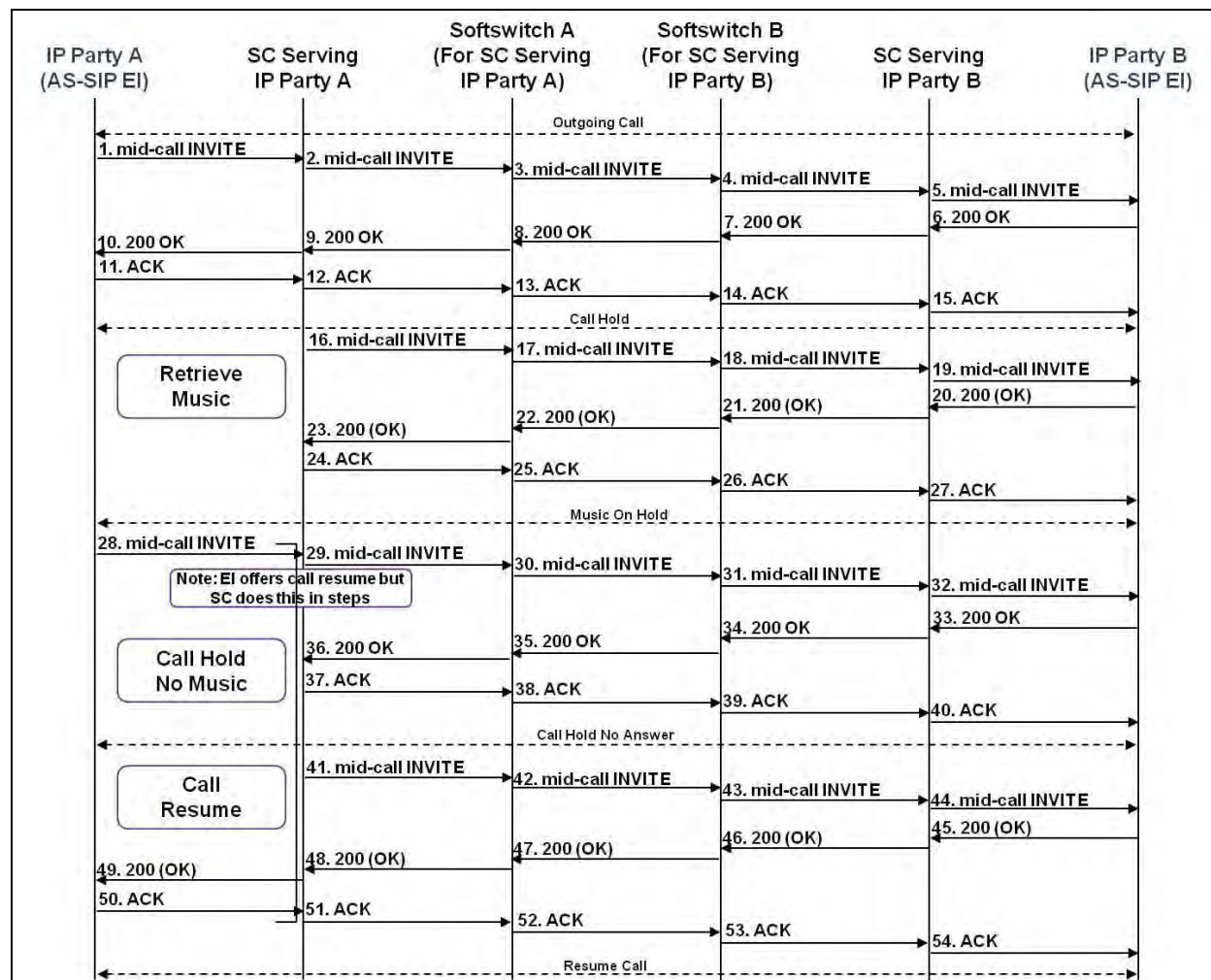

Figure 9.3-6. IP-to-IP Music on Hold (AS-SIP EIs)

AS-SIP EI B receives the INVITE (Step 5), responds with a 200 (OK) response (Step 6), and stops sending and receiving or processing the media stream. The 200 (OK) response includes an sdp answer where:

- If the sdp offer in Step 5 included the attribute line “a=sendonly,” then the sdp answer in the 200 (OK) response is either “a=recvonly” or “a=inactive.”
- If the sdp offer in Step 5 included the attribute line “a=inactive,” then the sdp answer in the 200 (OK) response is “a=inactive.”

AS-SIP EI A receives the 200 (OK) response (Step 10).

AS-SIP EI A sends an ACK (Step 11) and stops sending and receiving or processing the media stream. AS-SIP EI B receives the ACK (Step 15). The call is on hold now.

At Step 16, the SC serving AS-SIP EI A generates the mid-call re-INVITE that moves the bearer stream to the IP address and port of the media server and includes the “a=sendonly” attribute line.

NOTE: If the session on hold had been a video session, then the SDP offer in the INVITE sent by the SC serving AS-SIP EI A MUST continue to include a “hold” of the video media. The video media description offering the “hold” can use one of the following three formats:

- Specify a valid port number (other than zero) and include the attribute line `a=inactive` or
- Include a “c=” line set to zero for the video stream: `c=IN IP4 0.0.0.0` or
- Include a “c=” line set to zero for the video stream: `c=IN IP4 0.0.0.0` and include the attribute line `a=inactive`

At Step 19, AS-SIP EI B receives the re-INVITE.

NOTE: AS-SIP EI A is unaware of this re-INVITE.

At Step 20, AS-SIP EI B generates the 200 (OK) response with the sdp answer that includes the “a=recvonly” attribute.

The 200 (OK) response is forwarded back to the SC serving AS-SIP EI A and the SC serving AS-SIP EI A responds with an ACK, which is received by AS-SIP EI B at Step 27. At this point, music on hold is established from the media server to AS-SIP EI B.

NOTE: If the session on hold had been a video session then the SDP answer in the 200 (OK) sent by AS-SIP EI B MUST respond to the sdp offer of a “Held” video stream by including a corresponding video media description using one of the following three formats:

- Specify a valid port number (other than zero) and include the attribute line `a=inactive`.
- Include a “c=” line set to zero for the video stream: `c=IN IP4 0.0.0.0`.
- Include a “c=” line set to zero for the video stream: `c=IN IP4 0.0.0.0` and include the attribute line `a=inactive`.

NOTE: AS-SIP EI A is unaware of the sequence of messages that turned the simple hold to music on hold.

When the user at AS-SIP EI A is ready to resume the call that is on hold, then AS-SIP EI A sends a mid-call INVITE (Step 28) that includes the attribute line “a=sendrecv” if the stream originally had been a sendrecv media stream, or “a=recvonly” if the stream had been a recvonly stream.

The SC serving AS-SIP EI A now engages in a “two step” process to move the bearer back from the media server to the AS-SIP EI, and then to conduct the call resume with AS-SIP EI B.

The SC serving AS-SIP EI A stores the information relating to the re-INVITE received from AS-SIP EI A and generates a re-INVITE (Step 29) for removing the media server from the bearer path and returning the call state to a call hold without music. The re INVITE includes the attribute line “a=sendonly” if the stream had been a sendrecv media stream, or “a=inactive” if the stream had been a recvonly stream. The re INVITE includes a connection information “c=” line having the IP address of AS-SIP EI A unless SC A sets the “c” destination address to 0.0.0.0 per RFC 2543.

At Step 32, AS-SIP EI B receives the re-INVITE generated by the SC serving AS-SIP EI A. Thereupon, at Step 33, AS-SIP EI B creates a 200 (OK) with the sdp answer to return the call to the hold state with no music. If the sdp offer included the attribute line “a=sendonly,” then the sdp answer in the 200 (OK) response includes either the attribute “a=recvonly” or “a=inactive.” If the sdp offer included the attribute line “a=inactive,” then the sdp answer in the 200 (OK) response includes the attribute “a=inactive.”

The 200 (OK) response reaches the SC serving AS-SIP EI A (Step 36).

The SC serving AS-SIP EI A responds with an ACK (Step 37) that reaches AS-SIP EI B at step 40.

The SC serving AS-SIP EI A now generates a re-INVITE (Step 41) to resume the call that is on hold, using the same sdp offer that was generated by AS-SIP EI A in Step 28. The sdp offer includes the attribute line “a=sendrecv” if the stream originally had been a sendrecv media stream, or “a=recvonly” if the stream had been a recvonly stream.

NOTE: This re-INVITE is between the SC serving IP AS-SIP EI A and AS-SIP EI B.

The AS-SIP EI B receives the sdp offer (Step 44) and responds with a 200 (OK) (Step 45). If the sdp offer received in Step 44 has the “sendrecv,” attribute then in order to resume a “2-way” call the sdp answer will need to include the “sendrecv” Attribute. If the sdp offer received in Step 44 has the “a=recvonly,” attribute then the sdp answer includes “a=sendonly.”

At Step 48, the SC serving AS-SIP EI A receives the 200 (OK) response created by AS-SIP EI B, and now the SC serving AS-SIP EI A creates a 200 (OK) response to the Step 28 re INVITE from AS-SIP EI A and sends the 200 (OK) response, to AS-SIP EI A (Step 49).

NOTE: The sdp answer generated by the SC serving AS-SIP EI A matches the sdp answer in the 200 (OK) response that was received from AS-SIP EI B.

At Step 50 AS-SIP EI A responds to the 200 (OK) by sending an ACK that reaches AS-SIP EI B at Step 54.

Unpopulated INVITE Notes: When the SC serving AS-SIP EI A generates the INVITE at Step 16, the SC MAY generate an unpopulated INVITE intended for AS-SIP EI B. If this occurs then at Step 20 AS-SIP EI B will need to send a sdp offer having an audio media description that

includes either the “a=sendrecv” attribute or the “a=recvonly” attribute in order for Party B to hear the music on hold.

At Step 41 the SC serving AS-SIP EI A MAY generate an unpopulated INVITE intended for AS-SIP EI B. If this occurs then at Step 45 AS-SIP EI B will need to send a sdp offer having an audio media description that offers the required audio codecs and the attribute “a=sendrecv” in order to resume a “2-way” call. The SC serving AS-SIP EI A is responsible for completing the call resume by generating a 200 (OK) response with a sdp answer that it sends to AS-SIP EI A and an ACK with SDP answer that it sends to AS-SIP EI B.

9.4 CALL WAITING

Party A and Party B are engaged in a conversation. Call waiting consists of one party placing the other party on hold while either accepting or resuming a call with a third party.

9.4.1 IP-to-IP Call Type

SIP-006190 [Figure 9.4-1](#), IP-to-IP Call Waiting, depicts the sequence of AS-SIP messages between the AS-SIP signaling appliance serving IP Party A and the AS-SIP signaling appliance serving IP Party B that are used to place the current call on hold to accept a call from a third Party C, and to terminate the call with the third Party C to resume the original call.

The SSs have been omitted deliberately from the call flow diagram.

NOTE: There are other variations of call waiting, such as placing the current call on hold, answering a call from a third Party C, placing the call with the third Party C on hold, resuming the original call, and terminating the original call and resuming the call with the third Party C. However, the basic elements of call waiting involve the serial implementation of call hold and call resume as portrayed in [Figure 9.4-1](#).

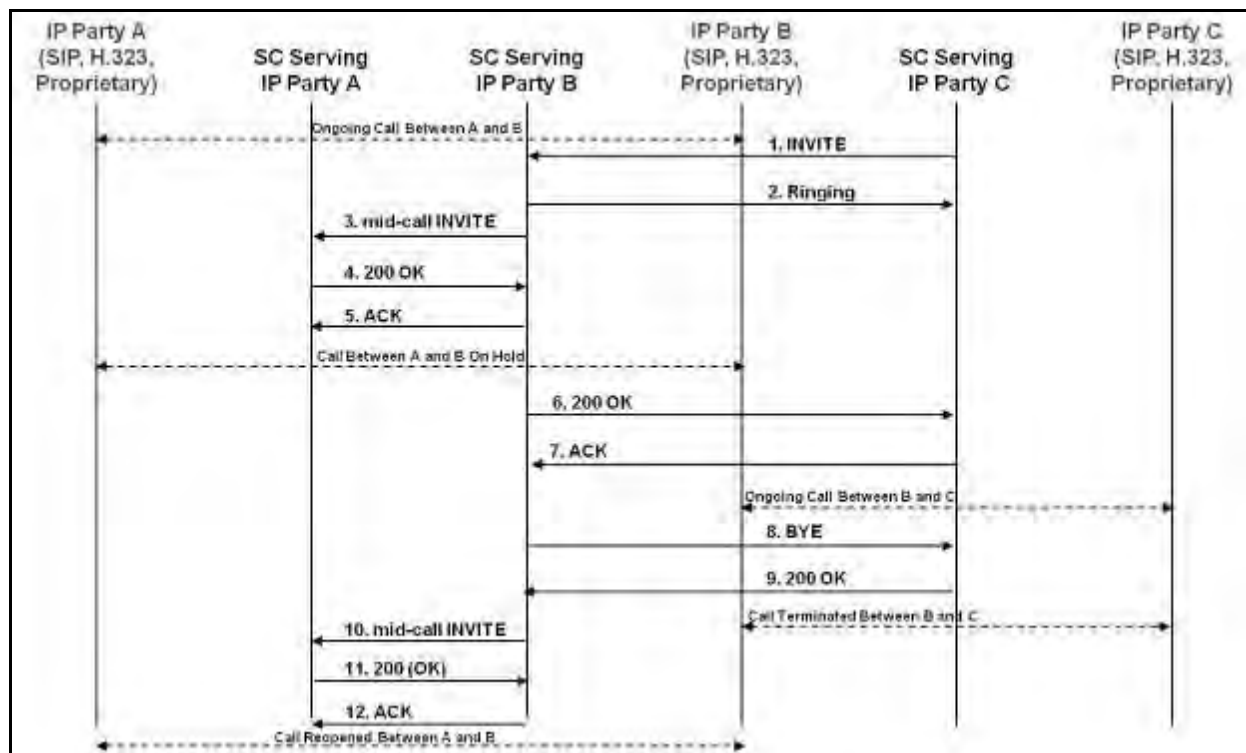

Figure 9.4-1. IP-to-IP Call Waiting

STEP	INSTRUCTION
1	Upon receiving an initial call request message from IP Party C (not depicted in call flow diagram), the SC serving IP Party C sends an INVITE to the SC serving IP Party B.
	NOTE: Signaling is not depicted between the EI serving IP Party C and the SC serving IP Party C. In addition, signaling is not depicted between the SC serving IP Party B and the EI serving Party B.
2	The SC serving IP Party B instructs the EI for IP Party B to alert the user of an incoming call request (i.e., call waiting tone) and sends a 180 (Ringing) response to the SC serving IP Party C.
	NOTE: Signaling is not depicted between the SC serving IP Party B and the EI serving IP Party B. In addition, signaling is not depicted between the SC serving IP Party C and the EI serving Party C.
3	In response to a request on the part of IP Party B, the SC serving IP Party B sends a mid-call INVITE to the SC serving IP Party A with the attribute line “a=sendonly” if the stream had been a sendrecv media stream, or “a=inactive” if the stream had been a recvonly stream (i.e., Party B initiates a call hold with Party A).
	NOTE: Party B MAY also support establishing a call hold by sending a mid-call INVITE that includes a session description that is the same as in the original request, but the “c” destination addresses for the media streams to be put on hold are set to zero: c=IN IP4 0.0.0.0.
	NOTE: Signaling is not depicted between the EI serving IP Party B and the SC serving IP Party B. In addition, signaling is not depicted between the SC serving IP Party A and the EI serving IP Party A.
4	The SC serving IP Party A sends a 200 (OK) response to the SC serving IP Party B.

STEP	INSTRUCTION
	If the sdp offer in the mid-call INVITE included the attribute line “a=sendonly,” then it is RECOMMENDED that the sdp answer in the 200 (OK) response responds with “a=recvonly.” If the sdp answer in the 200 (OK) response responds with an attribute other than “a=recvonly” (e.g., “a=sendonly” or “a=inactive”), then the SC serving Party B will accept the response and continue normal call processing.
	If the sdp offer in the mid-call INVITE included the attribute line “a=inactive,” then it is RECOMMENDED that the sdp answer in the 200 (OK) response responds with “a=inactive.” If the sdp answer in the 200 (OK) response responds with an attribute other than “a=inactive” (e.g., “a=recvonly” or “a=sendonly”), then the SC serving Party B will accept the response and continue normal call processing.
	NOTE: Signaling is not depicted between the EI serving IP Party A and the SC serving IP Party A. In addition, signaling is not depicted between the SC serving IP Party B and the EI serving IP Party B.
5	The SC serving IP Party B sends an ACK to the SC serving IP Party A.
	NOTE: Signaling is not depicted between the EI serving IP Party B and the SC serving IP Party B. In addition, signaling is not depicted between the SC serving IP Party A and the EI serving IP Party A.

The call between IP Party B and IP Party A is on hold now.

STEP	INSTRUCTION
6	The SC for IP Party B sends a 200 (OK) response to the SC for IP Party C.
	NOTE: Signaling is not depicted between the EI serving IP Party B and the SC serving IP Party B. In addition, signaling is not depicted between the SC serving IP Party C and the EI serving IP Party C.
7	The SC for IP Party C sends an ACK to the SC for IP Party B.
	NOTE: Signaling is not depicted between the EI serving IP Party C and the SC serving IP Party C. In addition, signaling is not depicted between the SC serving IP Party B and the EI serving IP Party B.

The call between IP Party C and IP Party B is established now.

STEP	INSTRUCTION
8	When IP Party B terminates the session with IP Party C, then the SC serving IP Party B sends a BYE request to the SC serving IP Party C.
	NOTE: Signaling is not depicted between the EI serving IP Party B and the SC serving IP Party B that initiated the call release. In addition, signaling is not depicted between the SC serving IP Party C and the EI serving IP Party C.
9	The SC serving IP Party C sends a 200 (OK) response to the SC serving IP Party B.
	NOTE: Signaling is not depicted between the EI serving IP Party C and the SC serving IP Party C. In addition, signaling is not depicted between the SC serving IP Party B and the EI serving IP Party B.

The call between IP Party C and IP Party B is terminated now.

STEP	INSTRUCTION
10	The SC serving IP Party B sends a mid-call re-INVITE to the SC for IP Party A that includes the attribute line “a=sendrecv” if the stream had originally been a sendrecv media stream, or “a=recvonly” if the stream had been a recvonly stream.
	NOTE: In the case of a call hold established by setting the “c” destination address to 0.0.0.0, another re-INVITE with the original address parameter terminates the call hold.
	NOTE: Signaling is not depicted between the EI serving IP Party B and the SC serving IP Party B. In addition, signaling is not depicted between the SC serving IP Party A and the EI serving IP Party A.
11	The SC serving IP Party A sends a 200 (OK) response to the SC serving IP Party B.
	NOTE: Signaling is not depicted between the EI serving IP Party A and the SC serving IP Party A. In addition, signaling is not depicted between the SC serving IP Party B and the EI serving IP Party B.
12	The SC serving IP Party B sends an ACK to the SC serving IP Party A.
	NOTE: Signaling is not depicted between the EI serving IP Party B and the SC serving IP Party B. In addition, signaling is not depicted between the SC serving IP Party A and the EI serving IP Party A.

The call between IP Party A and IP Party B is resumed now.

9.4.1.1 Successful Basic IP-to-IP Call Waiting (AS-SIP EI)

[Figure 9.4-2](#), IP-to-IP Call Waiting (AS-SIP EI), shows that AS-SIP EI A sends a mid-call INVITE (Step 1). The INVITE sdp body includes the attribute line “a=sendonly” if the stream had been a sendrecv media stream, or “a=inactive” if the stream had been a recvonly stream. AS-SIP EI B receives the INVITE (Step 5), responds with a 200 (OK) response (Step 6), and stops sending and receiving/processing the media stream. The 200 (OK) response includes an sdp answer where:

- If the sdp offer in Step 5 included the attribute line “a=sendonly,” then the sdp answer in the 200 (OK) response is “a=recvonly.” If the sdp answer in the 200 (OK) response responds with an attribute other than “a=recvonly” then the SC serving Party A will accept the response and continue normal call processing.
- If the sdp offer in Step 5 included the attribute line “a=inactive,” then the sdp answer in the 200 (OK) response is “a=inactive.” If the sdp answer in the 200 (OK) response responds with an attribute other than “a=inactive” (e.g., “a=recvonly” or “a=sendonly”), then the SC serving Party A will accept the response and continue normal call processing.

The AS-SIP EI A receives the 200 (OK) response (Step 10). If the sdp offer in Step 1 had been a=sendonly and the sdp answer in the 200 (OK) response is an attribute other than “a=recvonly” (e.g., “a=sendonly” or “a=inactive”), then AS-SIP EI A MUST accept the response and continue normal call processing. If the sdp offer in Step 1 had been a=inactive and the sdp answer in the 200 (OK) response responds with an attribute other than “a=inactive” (e.g., “a=recvonly” or

“a=sendonly”), then AS-SIP EI A MUST accept the response and continue normal call processing.

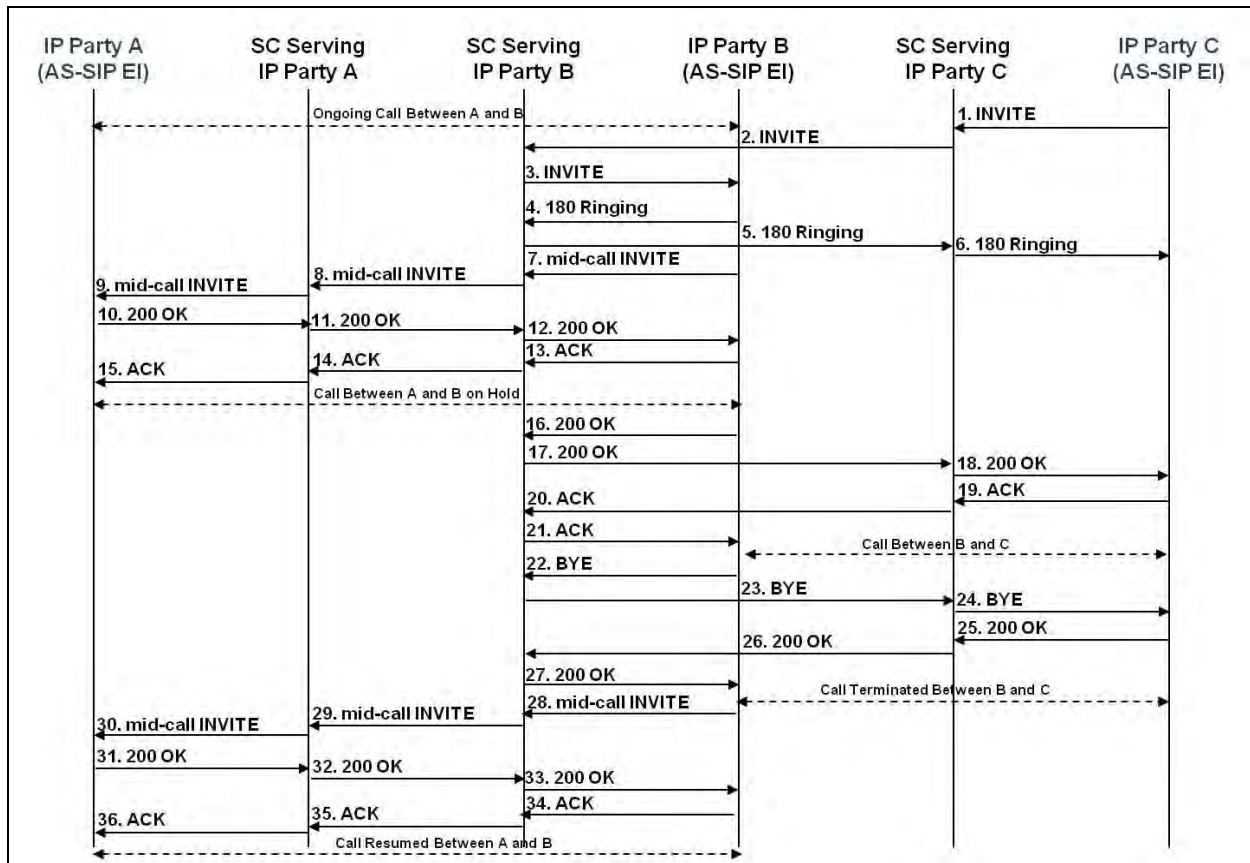

Figure 9.4-2. IP-to-IP Call Waiting (AS-SIP EI)

The AS-SIP EI A stops sending, receiving, and processing the media stream. AS-SIP EI A sends an ACK (Step 11). AS-SIP EI B receives the ACK (Step 15). The call is now on hold.

When the user at AS-SIP EI A is ready to resume the call that is on hold, then AS-SIP EI A sends a mid-call INVITE (Step 16) that includes the attribute line “a=sendrecv” if the stream originally had been a sendrecv media stream, or “a=recvonly” if the stream had been a recvonly stream. AS-SIP EI B receives the mid-call INVITE (Step 20). AS-SIP EI B sends a 200 (OK) response (Step 21). The 200 (OK) response includes an sdp answer where:

- If the sdp offer in Step 20 included the attribute line “a=sendonly,” then the sdp answer in the 200 (OK) response is “a=recvonly.” AS-SIP EI B resumes receiving or processing the media stream.
- If the sdp offer in Step 20 included the attribute line “a=inactive,” then the sdp answer in the 200 (OK) response is “a=sendrecv.” AS-SIP EI B resumes sending and receiving or processing the media stream.

The AS-SIP EI A receives the 200 (OK) response (Step 25), accepts the attribute line “a=recvonly” or “a=sendrecv.” If the attribute is “a=recvonly,” then AS-SIP EI A will send but not receive packets on the media stream; if the attribute is “a=sendrecv,” then AS-SIP EI A will send and receive packets on the media stream. AS-SIP EI A sends an ACK (Step 26). AS-SIP EI B receives the ACK (Step 30).

9.5 CALL FORWARD

9.5.1 Call Forward (Unconditional)

A user instructs that call requests to a particular telephone number be routed to a different predefined telephone number. In the following call flow diagrams, User B has instructed that call requests addressed to User B’s telephone number at location 1 be rerouted to a different telephone number for an EI at location 2.

NOTE: When the SC forwards an inbound call to a forwarded-to party the SC remains in the call signaling path. When the forwarded-to party is located at an external enclave reached over the UC WAN, then the SC allocates two call counts from the call count budget for the duration of the call even though no bearer traffic related to the given call actually transits the access link to the enclave where the SC is located.

9.5.1.1 IP-to-IP Call Type

SIP-006200 [Figure 9.5-1](#), IP-to-IP Call Forward (Unconditional), depicts the sequence of AS-SIP messages involved in the unconditional forwarding of a call request intended for IP Party B at location 1 to a forwarded telephone number (SIP URI) corresponding to an IP EI at location 2.

The SSs assigned to the SC serving IP Party A, IP Party B at location 1, and IP Party B at location 2 have been deliberately omitted from the call flow diagram.

Call Forward

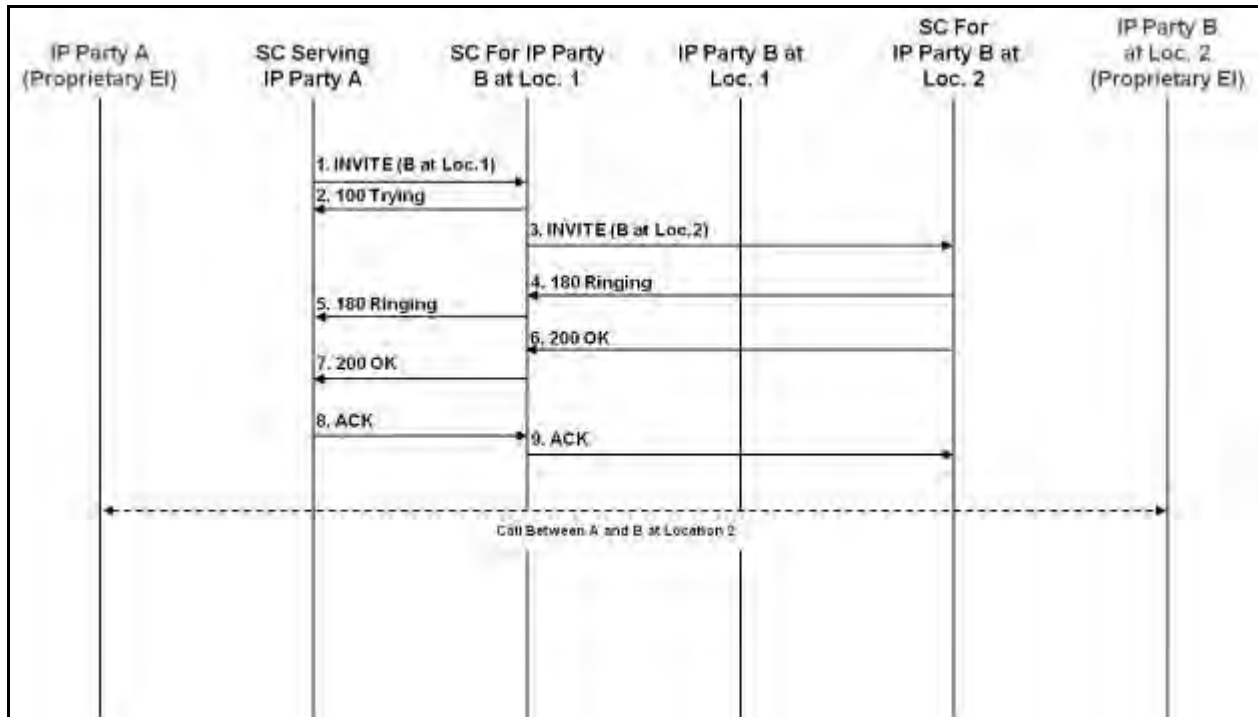

Figure 9.5-1. IP-to-IP Call Forward (Unconditional)

STEP	INSTRUCTION
1	The SC serving IP Party A sends an INVITE to the SC serving IP Party B at location 1. NOTE: Signaling is not depicted between the IP EI serving IP Party A and the SC serving IP Party A.
2	The SC serving IP Party B at location 1 sends a 100 (Trying) response to the SC serving IP Party A. NOTE: Signaling is not depicted between the SC serving IP Party A and Party A's IP EI.
3	Background: Previously, User B instructed the SC that all calls intended for the telephone number (SIP URI) associated with User B at location 1 be forwarded temporarily to another number (SIP URI) corresponding to an EI at location 2. The SC serving IP Party B at location 1 rewrites the Request URI and sends the INVITE to the SC serving IP Party B at location 2.
4, 5	The SC serving IP Party B at location 2 sends a 180 (Ringing) response to the SC serving IP Party B at location 1, which forwards the 180 (Ringing) response to the SC serving IP Party A. NOTE: Signaling is not depicted between the IP EI serving IP Party B at location 2 and the SC serving IP Party B at location 2. In addition, signaling is not depicted between the SC serving IP Party A and the IP EI serving IP Party A.
6, 7	The SC serving IP Party B at location 2 sends a 200 (OK) response to the SC serving IP Party B at location 1, which forwards the 200 (OK) response to the SC serving IP Party A. NOTE: Signaling is not depicted between the IP EI serving IP Party B at location 2 and the SC serving IP Party B at location 2. In addition, signaling is not depicted between the SC serving IP Party A and the IP EI serving IP Party A.

STEP	INSTRUCTION
8, 9	The SC serving IP Party A sends an ACK to the SC serving IP Party B at location 1, which forwards the ACK to the SC serving IP Party B at location 2.
	NOTE: Signaling is not depicted between the IP EI serving IP Party A and the SC serving IP Party A. In addition, signaling is not depicted between the SC serving IP Party B at location 2 and the IP EI serving IP Party B at location 2.

The forwarded call is established now between IP Party A and IP Party B at location 2.

9.5.1.1.1 Call Forward Unconditional (AS-SIP EI)

SIP-006210 The SC MUST provide a mechanism to allow users of AS-SIP EIs to enable and disable call forward busy for inbound calls to a user designated forwarded-to party. The SC vendor is free to offer either one or both of the following mechanisms:

- A vendor specified out of band mechanism such as a user web interface
- Star codes as described below

SIP-006220 [Conditional] If the SC supports the use of star codes then the AS-SIP EI and SC MUST implement the steps set forth in this requirement and depicted in [Figure 9.5-2](#) a in order for the user of an AS-SIP EI to employ star code ‘*72’ to instruct the SC to unconditionally forward calls to another DSN telephone number:

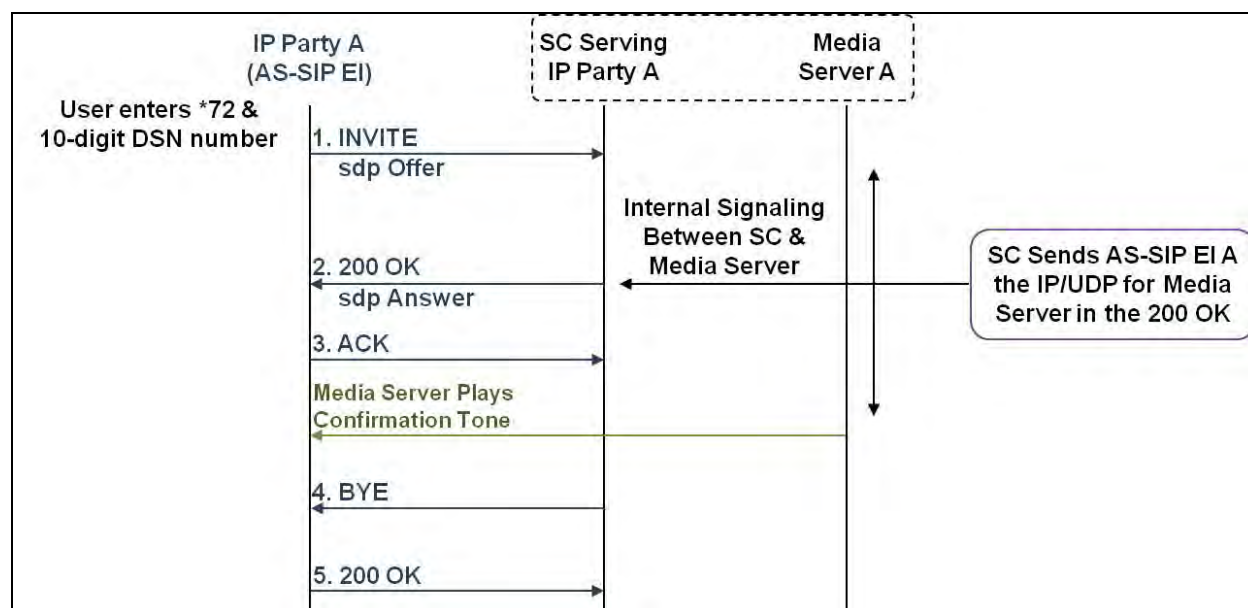

Figure 9.5-2. Call Flow Between AS-SIP EI and SC Using Star Code To Unconditionally Call Forward to a DSN Phone Number

STEP	INSTRUCTION
1	The user enters *72.
2-3	[Conditional] Upon receipt of the *72 input from the user, the AS-SIP EI MAY play a Recall Dial Tone to the user. It is not required that the AS-SIP EI play the Recall Dial Tone however if the AS-SIP EI does play the Recall Dial Tone then it MUST conform to the frequency, power and cadence set forth in Table 9.5-1 , Recall Dial Tone and Confirmation Dial Tone).
4	The user enters the 10-digit DSN number of the forward-to party.
	NOTE: It is permissible for the AS-SIP EI to require a keypad input or other delimiter such as pressing a softkey in order for the user to signal to the AS-SIP EI that the complete forward-to number has been entered and is ready to be sent to the SC.
5	The AS-SIP EI sends an INVITE to the SC in which the userinfo part of the Request-URI field is populated with “*72” and the 10-digit DSN number. The INVITE includes a sdp offer to enable establishment of a bearer between the SC and the AS-SIP EI.
	NOTE: The SC and the media server exchange the necessary signaling to provide the media server with the IP address and UDP port provided in the sdp offer by the AS-SIP EI and the media server provides the SC with the IP address and UDP port for the sdp answer to be sent by the SC to the AS-SIP EI in the 200 OK.
	NOTE: The media server is considered a part of the SC SUT therefore the signaling between the SC and media server is left to the vendor so long as the confirmation tone is played and the signaling between the SC and AS-SIP EI complies with the specific call flow depicted in this section.
6	The SC sends a 200 response with the sdp answer to the AS-SIP EI. The sdp offer/answer establishes a bearer between the media server and the AS-SIP EI.
7	The AS-SIP EI sends an ACK to the SC.
8	The SC instructs the media server to send a Confirmation tone to the AS-SIP EI. The Confirmation tone MUST conform to the frequency, power and cadence set forth in Table 9.5-1 .
	NOTE: SC MAY instruct media server to send a confirmation tone prior to Step 6 receipt of ACK from AS-SIP EI.
9	The INVITE transaction is terminated upon the occurrence of the first of the following two events:
	a. The user of the AS-SIP EI disconnects (‘hangs up’) within ten (10) seconds of the commencement of the confirmation tone. The AS-SIP EI sends a BYE and SC responds with a 200 OK, or
	b. Ten seconds elapse from the commencement of the confirmation tone and the SC does not receive a BYE from the AS-SIP EI. The SC sends a BYE to the AS-SIP EI and the AS-SIP EI responds with a 200 OK.

SIP-006220.a If the SC cannot successfully process the star 72 command received in Step 4 of SIP-006220 then at Step 7 the media server is instructed by the SC to play the reorder tone instead of the confirmation tone. The reorder tone MUST conform to the frequency, power and cadence set forth in [Table 9.5-1](#). The INVITE transaction is then completed in accordance with the provisions of Step 8.

Example of Request-URI field of INVITE where the forward-to number is the 10-digit DSN number 3151234567:

sip: *723151234567@uc.mil;user=phone

Table 9.5-1. Recall Dial Tone, Confirmation Tone, Reorder Tone

SIGNAL	FREQUENCIES (HZ)	POWER/FREQUENCY (DBM)	CADENCE
Recall Dial Tone	350 440	-13 -13	3x (On 100ms, Off 100ms), then On Steady
Confirmation Tone	350 440	-13 -13	2x (On 100ms, Off 100ms), then On 100ms and Off Steady
Reorder Tone	480 620	-24 -24	(On 250ms, Off 250ms) repeated continuously

SIP-006230 [Conditional] If the SC supports star codes then the procedure for enabling unconditional call forward to a PSTN phone number is the same as for a DSN number with the exception that the user enters an E.164 forward-to number instead of a 10-digit DSN number.

Example of Request-URI field of INVITE where the forward-to number is the PSTN number 2021234567 and the country code is 1 (US phone number):

sip: *7212021234567@uc.mil;user=phone

SIP-006240 [Conditional] If the SC supports the use of star codes then the AS-SIP EI and SC MUST implement the steps set forth in this requirement and depicted in [Figure 9.5-3](#) in order for the user of an AS-SIP EI to instruct the SC to deactivate unconditional call forward to another telephone number:

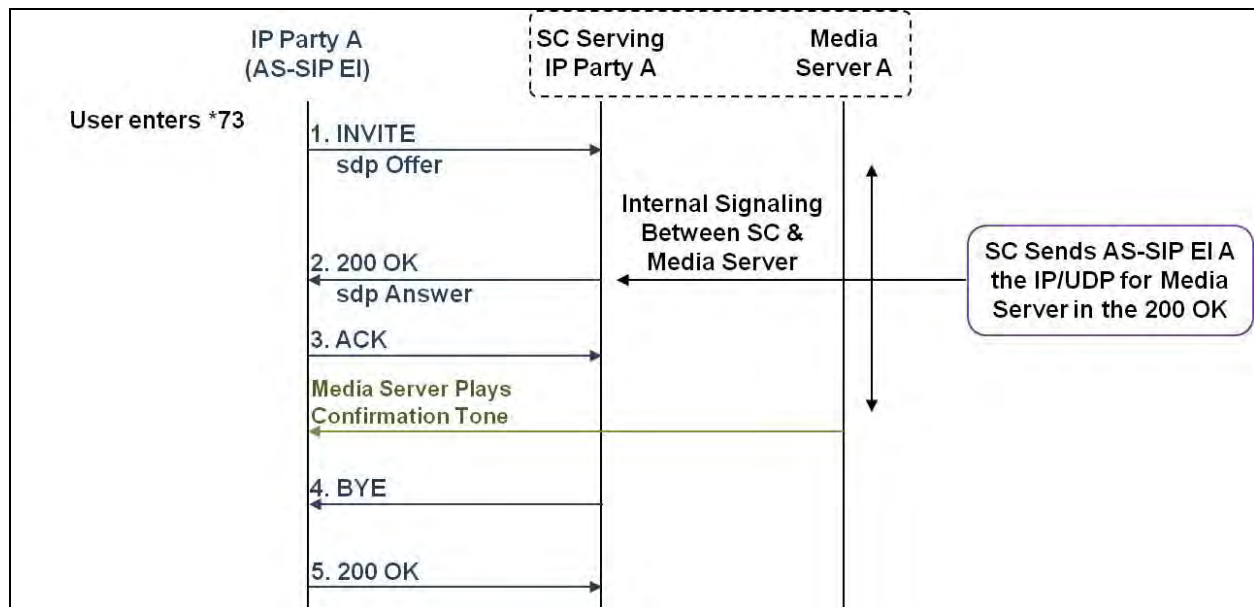

Figure 9.5-3. Call Flow Between AS-SIP EI and SC Using Star Code To Deactivate an Unconditional Call Forward

STEP	INSTRUCTION
1	The user enters *73.

STEP	INSTRUCTION
	NOTE: It is permissible for the AS-SIP EI to require a keypad input or other delimiter such as pressing a softkey in order for the user to signal to the AS-SIP EI that the star code is ready to be sent to the SC.
2	The AS-SIP EI sends an INVITE to the SC in which the userinfo part of the Request-URI field is populated with “*73.” The INVITE includes a sdp offer to enable establishment of a bearer between the SC and the AS-SIP EI.
	NOTE 1: The SC and the media server exchange the necessary signaling to provide the media server with the IP address and UDP port provided in the sdp offer by the AS-SIP EI and the media server provides the SC with the IP address and UDP port for the sdp answer to be sent by the SC to the AS-SIP EI in the 200 OK.
	NOTE 2: The media server is considered a part of the SC SUT therefore the signaling between the SC and media server is left to the vendor so long as the confirmation tone is played and the signaling between the SC and AS-SIP EI complies with the specific call flow depicted in this section.
3	The SC sends a 200 response with the sdp answer to the AS-SIP EI. The sdp offer/answer establishes a bearer between the media server and the AS-SIP EI.
4	The AS-SIP EI sends an ACK to the SC.
5	The SC instructs the media server to send a Confirmation tone to the AS-SIP EI. The Confirmation tone MUST conform to the frequency, power and cadence set forth in Table 9.5-1 .
	NOTE: SC MAY instruct media server to send a confirmation tone prior to Step 4 receipt of ACK from AS-SIP EI.
6	The INVITE transaction is terminated upon the occurrence of the first of the following 2 events:
	a. The user of the AS-SIP EI disconnects ('hangs up') within ten (10) seconds of the commencement of the confirmation tone. The AS-SIP EI sends a BYE and SC responds with a 200 OK, or
	b. Ten seconds elapse from the commencement of the confirmation tone and the SC does not receive a BYE from the AS-SIP EI. The SC sends a BYE to the AS-SIP EI and the AS-SIP EI responds with a 200 OK.

SIP-006240.a If the SC cannot successfully process the star 73 command received in Step 2 of SIP-006240 then at Step 5 the media server is instructed by the SC to play the reorder tone instead of the confirmation tone. The reorder tone MUST conform to the frequency, power and cadence set forth in [Table 9.5-1](#). The INVITE transaction is then completed in accordance with the provisions of Step 6.

Example of Request-URI field of INVITE whose userinfo part is *73:

sip: *73@uc.mil;user=phone

Referring to [Figure 9.5-4](#), IP-to-IP Call Forward (Unconditional) (AS-SIP EI), assume that at some time before the call request, the user IP Party B at location 1 (i.e., AS-SIP EI B at location 1) has enabled unconditional call forwarding to IP Party B at location 2 by sending a *72 with the DSN number of location 2 to its SC (i.e., SC for Party B at location 1).

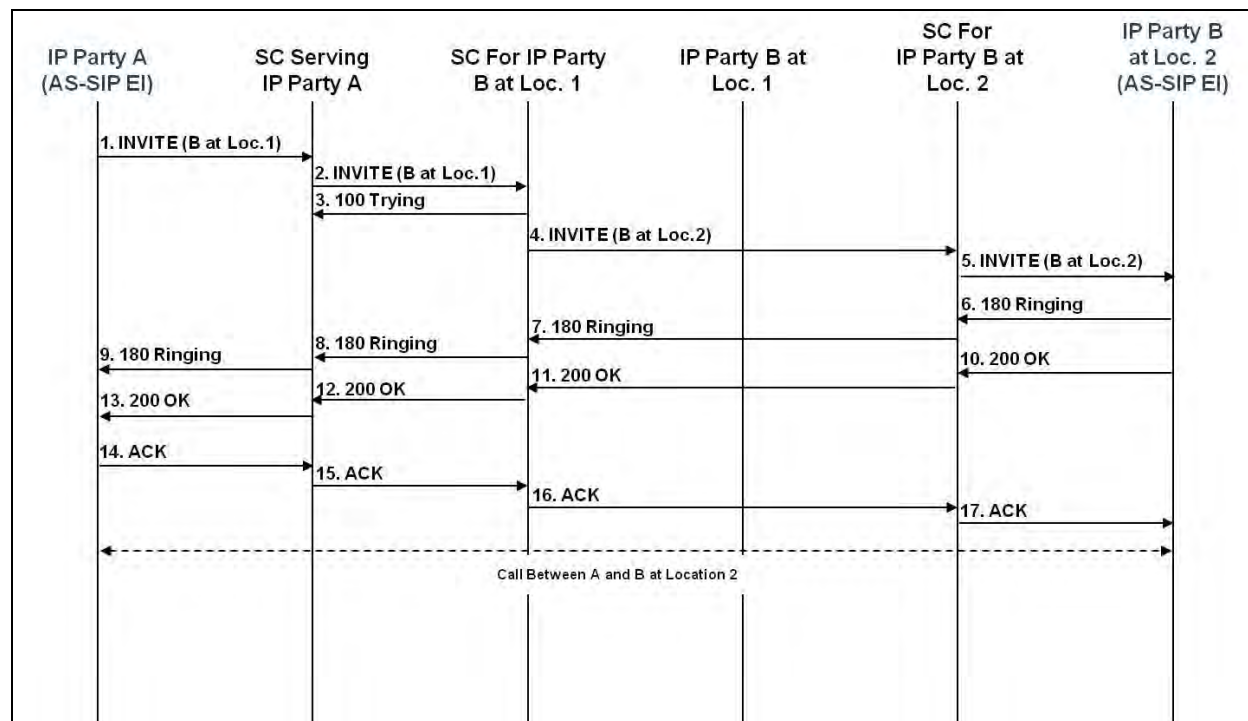

Figure 9.5-4. IP-to-IP Call Forward (Unconditional) (AS-SIP EI)

The AS-SIP EI A sends an INVITE (Step 1) to its SC, which is forwarded to the SC serving AS-SIP EI B at location 1. The SC serving AS-SIP EI B at location 1 forwards the INVITE through the network to the SC serving AS-SIP EI B at location 2 (Step 5). AS-SIP EI B at location 2 responds with a 180 (Ringing) response (Step 6), which is conveyed through the network to AS-SIP EI A (Step 9). When Party B at location 2 goes off-hook, then AS-SIP EI B at location 2 sends a 200 (OK) response (Step 10) across the network to AS-SIP EI A (Step 13). AS-SIP EI A responds with an ACK (Step 14) that is received by AS-SIP EI B at location 2 (Step 17).

9.5.2 Call Forward (No Answer)

A user instructs that call requests to a particular telephone number be routed to a different predefined telephone number if the call is not answered within some number of rings (No Answer). In the following call flow diagrams, User B has instructed that call requests addressed to User B’s telephone number at location 1, which receives no reply, be rerouted to a different telephone number for an EI at location 2.

As specified in [Section 4.6](#), SIP URI and Mapping of Telephony Number Into SIP URI, the addressing format for the SIP messages MUST be a SIP URI having a userinfo part that either is a number from the DSN worldwide numbering plan with the appropriate phone-context descriptor or an E.164 encoded telephone number and having a “user=phone” field appended to the URI.

NOTE: When the SC forwards an inbound call to a forwarded-to party the SC remains in the call signaling path. When the forwarded-to party is located at an external

enclave reached over the UC WAN, then the SC allocates two call counts from the call count budget for the duration of the call even though no bearer traffic related to the given call actually transits the access link to the enclave at which the SC is located.

9.5.2.1 IP-to-IP Call Type

SIP-006250 [Figure 9.5-5](#), IP-to-IP Call Forwarding on No Answer, depicts the sequence of AS-SIP messages involved in the forwarding of an unanswered call request intended for IP Party B at location 1 to a forwarded telephone number (SIP URI) corresponding to an IP EI at location 2.

The SSs assigned to the SC serving IP Party A, IP Party B at location 1, and IP Party B at location 2 have been omitted deliberately from the call flow diagram.

NOTE: The call flow diagram is based on Section 2.9 of draft-ietf-sipping-services-examples. The 100 (Trying) messages have been omitted.

NOTE: To convey the call flow in this scenario clearly, SIP EIs have been depicted and SIP signaling indicated between the SC and SIP EIs. In the case of H.323 and proprietary IP endpoints, comparable functionality must be provided in the signaling between the SCs and their served IP endpoints.

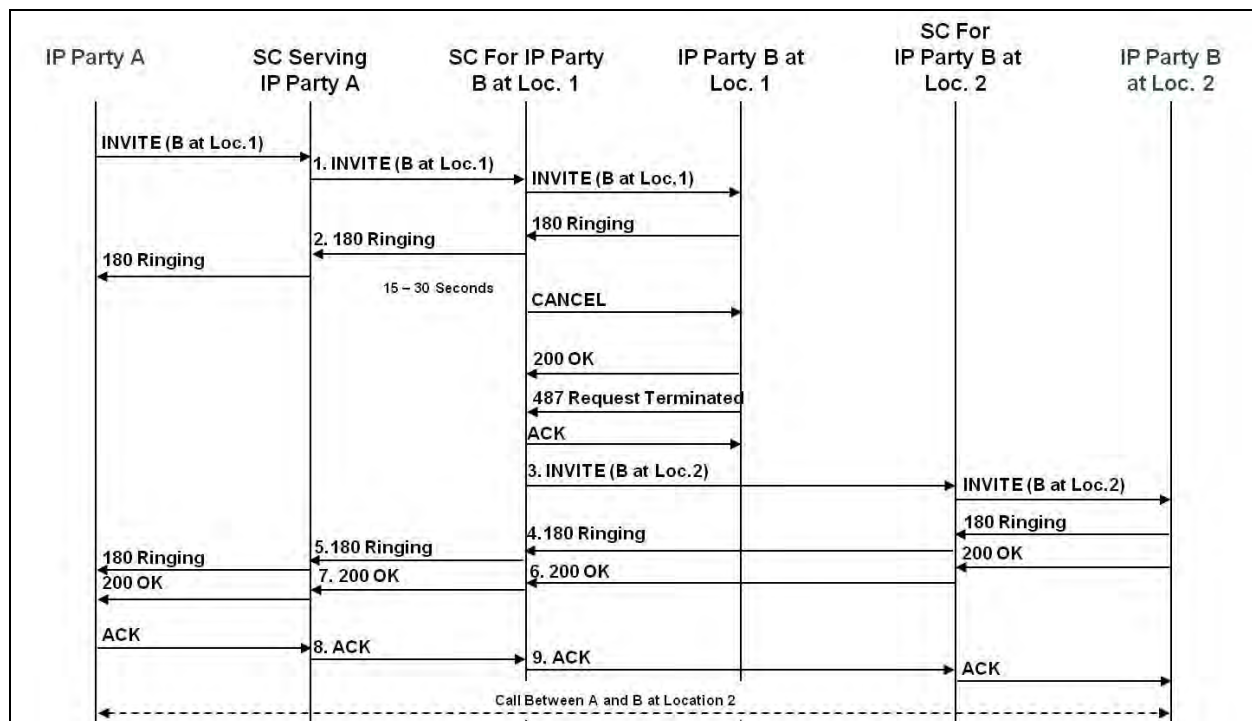

Figure 9.5-5. IP-to-IP Call Forwarding on No Answer

Call Forward (No Answer)

STEP	INSTRUCTION
1	IP Party A (a SIP EI) sends an INVITE to the SC serving IP Party A.
	The SC serving IP Party A sends an INVITE to the SC serving IP Party B at location 1. (The INVITE is ultimately intended for IP Party B at location 1.)
	User B has previously instructed the SC serving IP Party B at location 1 that in the event of no reply, the call is to be forwarded to another number (SIP URI) corresponding to an EI at location 2. The SC will notify the IP EI of the pending call request, and if there is no answer within a predefined period, then the SC serving IP Party B at location 1 will rewrite the Request URI and send it to the SC serving IP Party B at location 2.
	The SC serving IP Party B at location 1 sends the INVITE to IP Party B at location 1 (which is a SIP EI).
2	IP Party B at location 1 sends a 180 (Ringing) response to the SC serving IP Party B at location 1.
	The SC serving IP Party B at location 1 forwards the 180 (Ringing) response to the SC serving IP Party A.
	The SC serving IP Party A forwards the 180 (Ringing) to IP Party A.
3	When there is no answer within a configurable amount of time, the request times out.
	The SC serving IP Party B at location 1 sends a CANCEL request to IP Party B at location 1. IP Party B at location 1 responds with a 200 (OK) response to the CANCEL and a 487 (Request Terminated) response to the INVITE. The SC serving IP Party B at location 1 sends an ACK for the 487 (Request Terminated) response.*
	The SC serving IP Party B at location 1 rewrites the Request URI and sends the INVITE to the SC serving IP Party B at location 2.
	The SC serving IP Party B at location 2 forwards the INVITE to IP Party B at location 2 (which is a SIP EI).
4, 5	IP Party B at location 2 sends a 180 (Ringing) response to the SC serving IP Party B at location 2.
	The SC serving IP Party B at location 2 sends the 180 (Ringing) response to the SC serving IP Party B at location 1. The SC serving IP Party B at location 1 sends the 180 (Ringing) response to the SC serving IP Party A.
	The SC serving IP Party A sends the 180 (Ringing) response to IP Party A.
6, 7	IP Party B at location 2 goes off-hook and the SIP EI sends a 200 (OK) response to the SC serving IP Party B at location 2.
	The SC serving IP Party B at location 2 sends the INVITE to the SC serving IP Party B at location 1. The SC serving IP Party B at location 1 sends the 180 (Ringing) response to the SC serving IP Party A.
	The SC serving IP Party A sends the 200 (OK) response to IP Party A.
8, 9	IP Party A sends an ACK to the SC serving IP Party A.
	The SC serving IP Party A sends the ACK to the SC serving IP Party B at location 1, which sends the ACK to the SC serving IP Party B at location 2.
	The SC serving IP Party B at location 2 sends the ACK to IP Party B at location 2.
*RFC 2543-compliant IP EIs will not send a 487 (Request Terminated) response to the INVITE.	

The forwarded call is established now between IP Party A and IP Party B at location 2.

9.5.2.1.1 Call Forward No Answer (AS-SIP EI)

SIP-006260 The SC MUST provide a mechanism to allow users of AS-SIP EIs to enable and disable call forward busy for inbound calls to a user designated forwarded-to party. The SC vendor is free to offer either one or both of the following mechanisms:

- A vendor specified out of band mechanism such as a user web interface.
- Star codes as described below.

SIP-006270 [Conditional] If the SC supports the use of star codes then the AS-SIP EI and SC MUST implement the steps set forth in this requirement and depicted in [Figure 9.5-6](#) in order for the user of an AS-SIP EI to employ star code “*92” to instruct the SC to forward calls on no answer to another DSN telephone number:

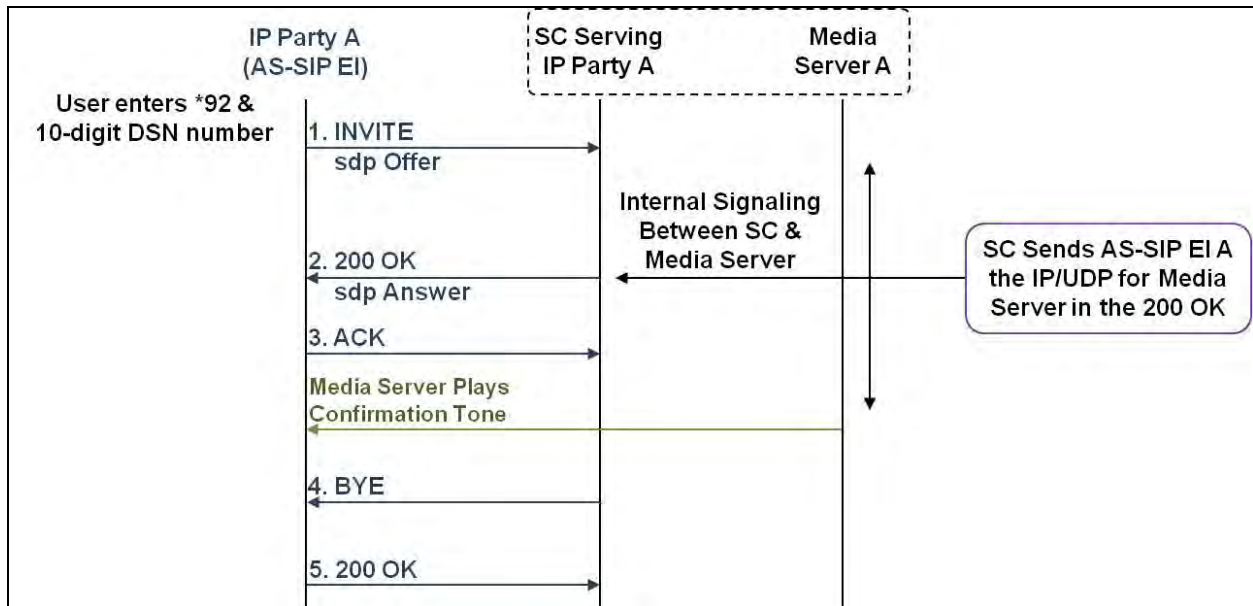

Figure 9.5-6. Call Flow Between AS-SIP EI and SC Using Star Code To Call Forward on No Answer to a DSN Phone Number

STEP	INSTRUCTION
1	The user enters *92.
2	[Conditional] Upon receipt of the *92 input from the user, the AS-SIP EI MAY play a Recall Dial Tone to the user. It is not required that the AS-SIP EI play the Recall Dial Tone however if the AS-SIP EI does play the Recall Dial Tone then it MUST conform to the frequency, power and cadence set forth in Table 9.5-1 Recall Dial Tone and Confirmation Dial Tone).
3	The user enters the 10-digit DSN number of the forward-to party.
	NOTE: It is permissible for the AS-SIP EI to require a keypad input or other delimiter such as pressing a softkey in order for the user to signal to the AS-SIP EI that the complete forward-to number has been entered and is ready to be sent to the SC.

STEP	INSTRUCTION
4	The AS-SIP EI sends an INVITE to the SC in which the userinfo part of the Request-URI field is populated with “*92” and the 10-digit DSN number. The INVITE includes a sdp offer to enable establishment of a bearer between the SC and the AS-SIP EI.
	NOTE 1: The SC and the media server exchange the necessary signaling to provide the media server with the IP address and UDP port provided in the sdp offer by the AS-SIP EI and the media server provides the SC with the IP address and UDP port for the sdp answer to be sent by the SC to the AS-SIP EI in the 200 OK.
	NOTE 2: The media server is considered a part of the SC SUT therefore the signaling between the SC and media server is left to the vendor so long as the confirmation tone is played and the signaling between the SC and AS-SIP EI complies with the specific call flow depicted in this section.
5	The SC sends a 200 response with the sdp answer to the AS-SIP EI. The sdp offer/answer establishes a bearer between the media server and the AS-SIP EI.
6	The AS-SIP EI sends an ACK to the SC.
7	The SC instructs the media server to send a Confirmation tone to the AS-SIP EI. The Confirmation tone MUST conform to the frequency, power and cadence set forth in Table 9.5-1 .
	NOTE: SC MAY instruct media server to send a confirmation tone prior to Step 6 receipt of ACK from AS-SIP EI.
8	The INVITE transaction is terminated upon the occurrence of the first of the following two events:
	a. The user of the AS-SIP EI disconnects (‘hangs up’) within 10 seconds of the commencement of the confirmation tone. The AS-SIP EI sends a BYE and SC responds with a 200 OK, or
	b. Ten seconds elapse from the commencement of the confirmation tone and the SC does not receive a BYE from the AS-SIP EI. The SC sends a BYE to the AS-SIP EI and the AS-SIP EI responds with a 200 OK.

SIP-006270.a SIP-006180.1 If the SC cannot successfully process the star 92 command received in Step 4 of SIP-006270 then at Step 7 the media server is instructed by the SC to play the reorder tone instead of the confirmation tone. The reorder tone MUST conform to the frequency, power and cadence set forth in [Table 9.5-1](#). The INVITE transaction is then completed in accordance with the provisions of Step 8.

Example of Request-URI field of INVITE where the forward-to number is the 10-digit DSN number 3151234567:

sip: *923151234567@uc.mil;user=phone

SIP-006280 [Conditional] If the SC supports star codes then the procedure for enabling call forward on no answer to a PSTN phone number is the same as for a DSN number with the exception that the user enters an E.164 forward-to number instead of a 10-digit DSN number.

Example of Request-URI field of INVITE where the forward-to number is the PSTN number 2021234567 and the country code is 1 (US phone number):

sip: *9212021234567@uc.mil;user=phone

SIP-006290 [Conditional] If the SC supports the use of star codes then the AS-SIP EI and SC MUST implement the steps set forth in this requirement and depicted in [Figure 9.5-7](#) in order for the user of an AS-SIP EI to instruct the SC to deactivate call forward on no answer to another telephone number:

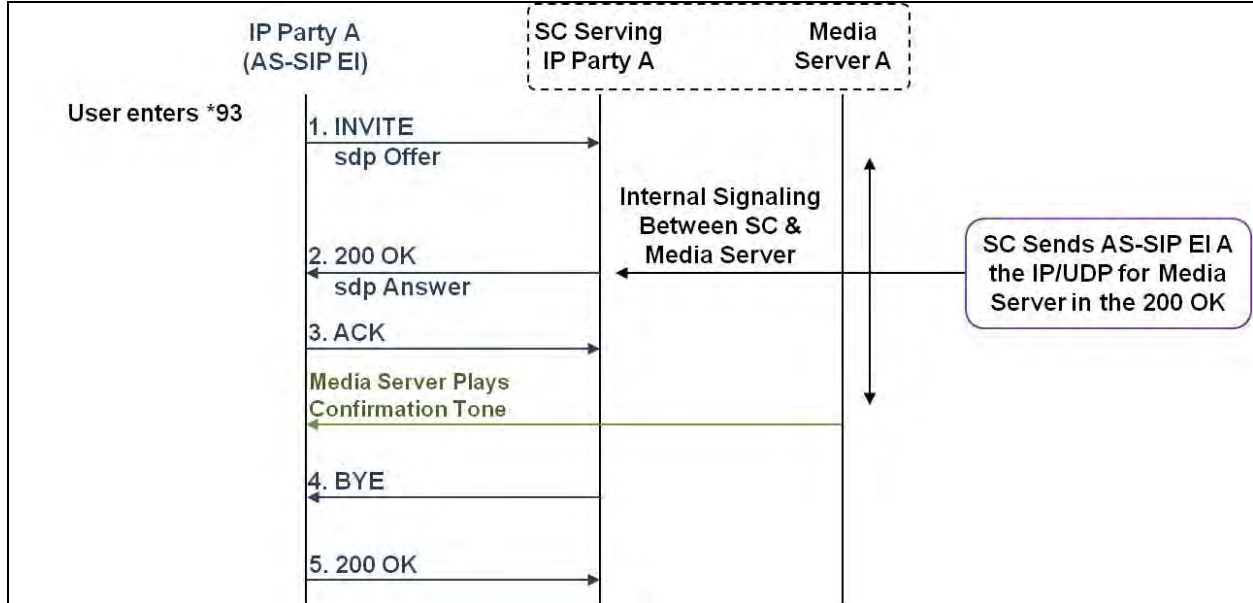

Figure 9.5-7. Call Flow Between AS-SIP EI and SC Using Star Code To Deactivate Call Forward on No Answer

STEP	INSTRUCTION
1	The user enters *93.
	NOTE: It is permissible for the AS-SIP EI to require a keypad input or other delimiter such as pressing a softkey in order for the user to signal to the AS-SIP EI that the star code is ready to be sent to the SC.
2	The AS-SIP EI sends an INVITE to the SC in which the userinfo part of the Request-URI field is populated with "*93." The INVITE includes a sdp offer to enable establishment of a bearer between the SC and the AS-SIP EI.
	NOTE: The SC and the media server exchange the necessary signaling to provide the media server with the IP address and UDP port provided in the sdp offer by the AS-SIP EI and the media server provides the SC with the IP address and UDP port for the sdp answer to be sent by the SC to the AS-SIP EI in the 200 OK.
	NOTE: The media server is considered a part of the SC SUT therefore the signaling between the SC and media server is left to the vendor so long as the confirmation tone is played and the signaling between the SC and AS-SIP EI complies with the specific call flow depicted in this section.
3	The SC sends a 200 response with the sdp answer to the AS-SIP EI. The sdp offer/answer establishes a bearer between the media server and the AS-SIP EI.
4	The AS-SIP EI sends an ACK to the SC.
5	The SC instructs the media server to send a Confirmation tone to the AS-SIP EI. The Confirmation tone MUST conform to the frequency, power and cadence set forth in Table 9.5-1 .

STEP	INSTRUCTION
	NOTE: SC MAY instruct media server to send a confirmation tone prior to Step 4 receipt of ACK from AS-SIP EI.
6	The INVITE transaction is terminated upon the occurrence of the first of the following two events:
	a. The user of the AS-SIP EI disconnects ('hangs up') within 10 seconds of the commencement of the confirmation tone. The AS-SIP EI sends a BYE and SC responds with a 200 OK, or
	b. Ten seconds elapse from the commencement of the confirmation tone and the SC does not receive a BYE from the AS-SIP EI. The SC sends a BYE to the AS-SIP EI and the AS-SIP EI responds with a 200 OK.

SIP-006290.a If the SC cannot successfully process the star 93 command received in Step 2 of SIP-00690 then at Step 5 the media server is instructed by the SC to play the reorder tone instead of the confirmation tone. The reorder tone MUST conform to the frequency, power and cadence set forth in [Table 9.5-1](#). The INVITE transaction is then completed in accordance with the provisions of Step 6.

Example of Request-URI field of INVITE whose userinfo part is*93:

sip: *93@uc.mil;user=phone

Referring to [Figure 9.5-8](#), IP-to-IP Call Forwarding on No Answer (AS-SIP EI), assume that at some time before the call request, the user IP Party B at location 1 (i.e., AS-SIP EI B at location 1) has enabled call forwarding no answer to IP Party B at location 2 by sending a *92 with the DSN number of location 2 to its SC (i.e., SC for Party B at location 1).

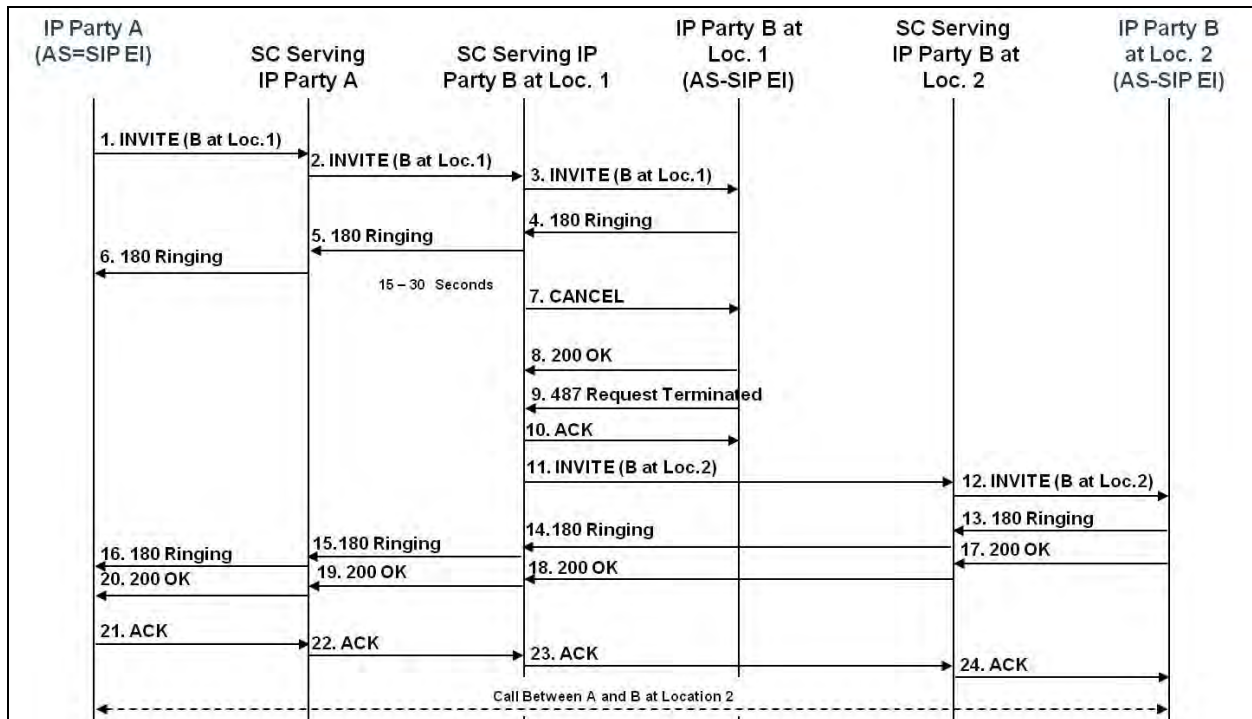

Figure 9.5-8. IP-to-IP Call Forwarding on No Answer (AS-SIP EI)

AS-SIP EI A sends an INVITE (Step 1) to its SC, which is forwarded to the AS-SIP EI B at location 1 (Step 3). AS-SIP EI B at location 1 responds with a 180 (Ringing) response (Step 4), which is forward to AS-SIP EI A (Step 6). AS-SIP EI B at location 1 does not respond further within a configurable time (e.g., 15–30 seconds) and the SC serving AS-SIP EI B at location 1 sends a CANCEL (Step 7) to AS-SIP EI B at location 1. In response, AS-SIP EI B at location 1 sends a 200 (OK) response (Step 9) and a 487 (Request Terminated) response (Step 10) to its SC. The SC serving AS-SIP EI B at location 1 rewrites the Request URI and sends the INVITE through the network to AS-SIP EI B at location (received by AS-SIP EI B at location 2 in Step 12). AS-SIP EI B at location 2 responds with a 180 (Ringing) response (Step 13), which is conveyed through the network to AS-SIP EI A (Step 16). When Party B at location 2 goes off-hook, then AS-SIP EI B at location 2 sends a 200 (OK) response (Step 17) across the network to AS-SIP EI A (Step 20). AS-SIP EI A responds with an ACK (Step 21) that is received by AS-SIP EI B at location 2 (Step 24).

9.5.3 Call Forward (Busy)

A user instructs that call requests to a particular telephone number be routed to a different predefined telephone number if the EI is busy with another call. In the following call flow diagrams, User B has instructed that when a call request is addressed to User B's telephone at location 1 but the phone is currently busy with another call, then the new call request is to be forwarded to an EI at location 2.

Recalling Requirement SIP-004960, the new call request will be forwarded only if the existing call either has an equal or higher precedence level than the incoming call request. If the existing call has a lower precedence than the incoming call request, then the existing call will be preempted in favor of the new call request.

NOTE: When the SC forwards an inbound call to a forwarded-to party the SC remains in the call signaling path. When the forwarded-to party is located at an external enclave reached over the UC WAN, then the SC allocates two call counts from the call count budget for the duration of the call even though no bearer traffic related to the given call actually transits the access link to the enclave where the SC is located.

9.5.3.1 IP-to-IP Call Type

SIP-006300 [Figure 9.5-9](#), IP-to-IP Call Forwarding Busy, depicts the sequence of AS-SIP messages involved in the forwarding of a call request intended for IP Party B at location 1. However, the EI for IP Party B at location 1 is currently busy with a call of equal or higher precedence than the incoming call request, so the call request is forwarded to another telephone number (SIP URI) corresponding to an IP EI at location 2.

The SSs assigned to the SC serving IP Party A, IP Party B at location 1, and IP Party B at location 2 have been deliberately omitted from the call flow diagram.

NOTE: The call flow diagram is based on Section 2.8 of draft-ietf-sipping-services-examples. The 100 (Trying) messages have been omitted.

NOTE: To convey the call flow in this scenario clearly, SIP EIs have been depicted and indicated SIP signaling indicated between the SC and SIP EIs. In the case of H.323 and proprietary IP endpoints, comparable functionality must be provided in the signaling between the SCs and their served IP endpoints.

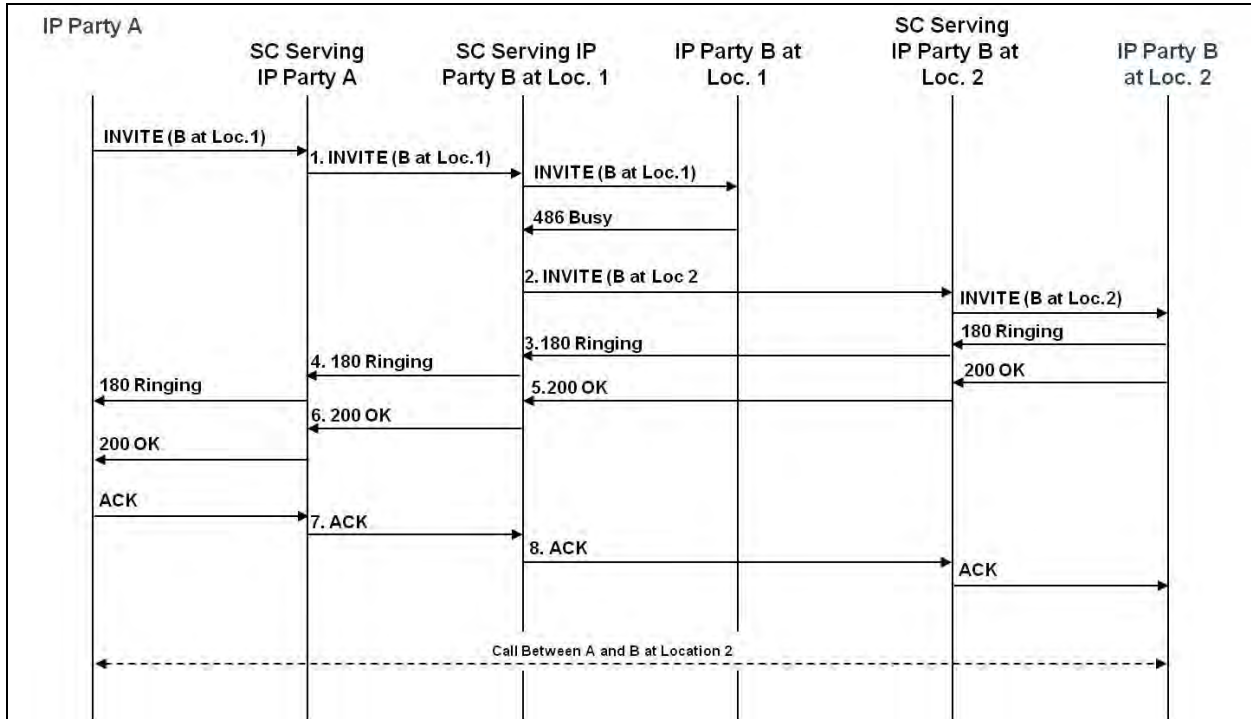

Figure 9.5-9. IP-to-IP Call Forwarding Busy

STEP	INSTRUCTION
1	IP Party A (a SIP EI) sends an INVITE to the SC serving IP Party A.
	The SC serving IP Party A sends an INVITE to the SC serving IP Party B at location 1. (The INVITE is ultimately intended for IP Party B at location 1.)
	User B has previously instructed the SC serving IP Party B at location 1 that in the event the EI for IP Party B at location 1 is busy, the call is to be forwarded to another number (SIP URI) corresponding to an EI at location 2.
	The SC serving IP Party B at location 1 sends the INVITE to IP Party B at location 1 (which is a SIP EI).
2	IP Party B at location 1 sends a 486 (Busy) response to the SC serving IP Party B at location 1.
	The SC serving IP Party B at location 1 responds with an ACK to IP Party B at location 1.
	The SC serving IP Party B at location 1 rewrites the Request URI and sends the INVITE to the SC serving IP Party B at location 2.
	The SC serving IP Party B at location 2 forwards the INVITE to IP Party B at location 2, which is a SIP EI.

STEP	INSTRUCTION
3, 4	IP Party B at location 2 sends a 180 (Ringing) response to the SC serving IP Party B at location 2.
	The SC serving IP Party B at location 2 sends the 180 (Ringing) response to the SC serving IP Party B at location 1. The SC serving IP Party B at location 1 sends the 180 (Ringing) response to the SC serving IP Party A.
	The SC serving IP Party A sends the 180 (Ringing) response to IP Party A.
5, 6	IP Party B at location 2 goes off-hook and sends a 200 (OK) response to the SC serving IP Party B at location 2.
	The SC serving IP Party B at location 2 sends the INVITE to the SC serving IP Party B at location 1. The SC serving IP Party B at location 1 sends the 180 (Ringing) response to the SC serving IP Party A.
	The SC serving IP Party A sends a 200 (OK) response to IP Party A.
7, 8	IP Party A sends an ACK to the SC serving IP Party A.
	The SC serving IP Party A sends the ACK to the SC serving IP Party B at location 1, which sends the ACK to the SC serving IP Party B at location 2.
	The SC serving IP Party B at location 2 sends the ACK to IP Party B at location 2.

9.5.3.1.1 *Call Forward Busy (AS-SIP EI)*

SIP-006310 The SC MUST provide a mechanism to allow users of AS-SIP EIs to enable and disable call forward busy for inbound calls to a user designated forwarded-to party. The SC vendor is free to offer either one or both of the following mechanisms:

- A vendor specified out of band mechanism such as a user Web interface.
- Star codes as described below.

SIP-006320 [Conditional] If the SC supports the use of star codes then the AS-SIP EI and SC MUST implement the steps set forth in this requirement and depicted in [Figure 9.5-10](#) in order for the user of an AS-SIP EI to employ star code ‘*90’ to instruct the SC to call forward busy to another DSN telephone number:

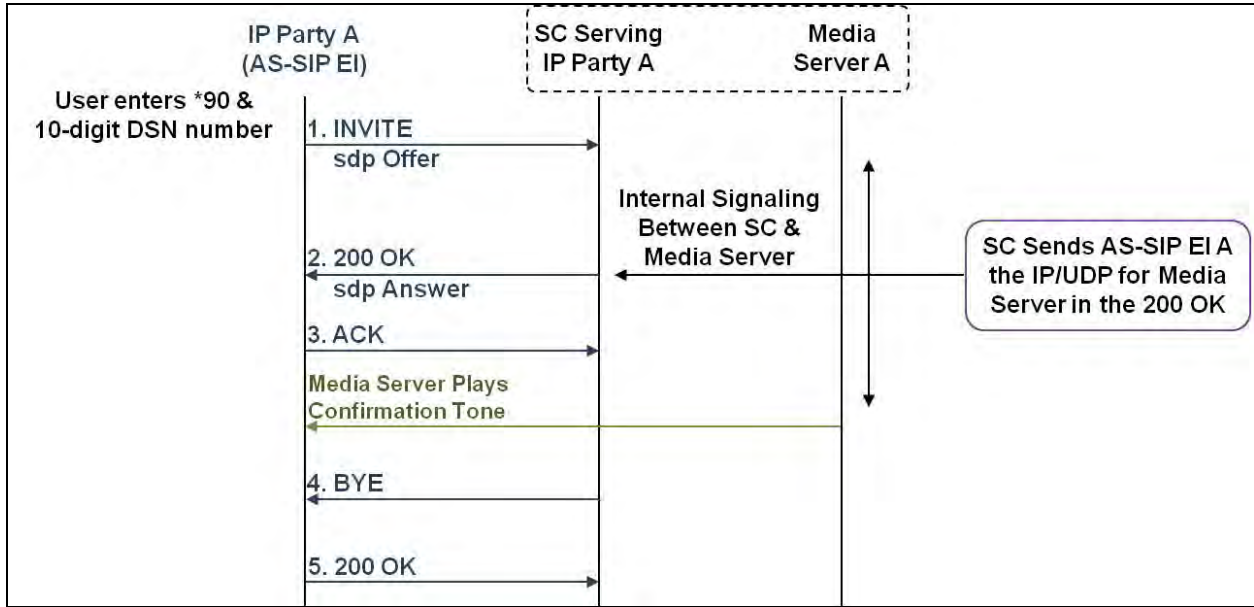

Figure 9.5-10. Call Flow Between AS-SIP EI and SC Using Star Code To Call Forward Busy to a DSN Phone Number

STEP	INSTRUCTION
1	The user enters *90.
2	[Conditional] Upon receipt of the *90 input from the user, the AS-SIP EI MAY play a Recall Dial Tone to the user. It is not required that the AS-SIP EI play the Recall Dial Tone however if the AS-SIP EI does play the Recall Dial Tone then it MUST conform to the frequency, power and cadence set forth in Table 9.5-1 , Recall Dial Tone and Confirmation Dial Tone.
3	The user enters the 10-digit DSN number of the forwarded-to party.
	NOTE: It is permissible for the AS-SIP EI to require a keypad input or other delimiter such as pressing a softkey in order for the user to signal to the AS-SIP EI that the complete forwarded-to number has been entered and is ready to be sent to the SC.
4	The AS-SIP EI sends an INVITE to the SC in which the userinfo part of the Request-URI field is populated with “*90” and the 10-digit DSN number. The INVITE includes a sdp offer to enable establishment of a bearer between the SC and the AS-SIP EI.
	NOTE 1: The SC and the media server exchange the necessary signaling to provide the media server with the IP address and UDP port provided in the sdp offer by the AS-SIP EI and the media server provides the SC with the IP address and UDP port for the sdp answer to be sent by the SC to the AS-SIP EI in the 200 OK.
	NOTE 2: The media server is considered a part of the SC SUT therefore the signaling between the SC and media server is left to the vendor so long as the confirmation tone is played and the signaling between the SC and AS-SIP EI complies with the specific call flow depicted in this section.
5	The SC sends a 200 response with the sdp answer to the AS-SIP EI. The sdp offer/answer establishes a bearer between the media server and the AS-SIP EI.
6	The AS-SIP EI sends an ACK to the SC.
7	The SC instructs the media server to send a Confirmation tone to the AS-SIP EI. The Confirmation tone MUST conform to the frequency, power and cadence set forth in Table 9.5-1 .

STEP	INSTRUCTION
	NOTE: SC MAY instruct media server to send a confirmation tone prior to Step 6 receipt of ACK from AS-SIP EI.
8	The INVITE transaction is terminated upon the occurrence of the first of the following two events:
	a. The user of the AS-SIP EI disconnects ('hangs up') within ten seconds of the commencement of the confirmation tone. The AS-SIP EI sends a BYE and SC responds with a 200 OK, or
	b. Ten seconds elapse from the commencement of the confirmation tone and the SC does not receive a BYE from the AS-SIP EI. The SC sends a BYE to the AS-SIP EI and the AS-SIP EI responds with a 200 OK.

SIP-006320.a If the SC cannot successfully process the star 90 command received in Step 4 of SIP-006320 then at Step 7 the media server is instructed by the SC to play the reorder tone instead of the confirmation tone. The reorder tone MUST conform to the frequency, power and cadence set forth in [Table 9.5-1](#). The INVITE transaction is then completed in accordance with the provisions of Step 8.

Example of Request-URI field of INVITE where the forward-to number is the 10-digit DSN number 3151234567:

sip: *903151234567@uc.mil;user=phone

SIP-006330 [Conditional] If the SC supports star codes then the procedure for enabling call forward busy to a PSTN phone number is the same as for a DSN number with the exception that the user enters an E.164 forward-to number instead of a 10-digit DSN number.

Example of Request-URI field of INVITE where the forward-to number is the PSTN number 2021234567 and the country code is 1 (US phone number):

sip: *9012021234567@uc.mil;user=phone

SIP-006340 [Conditional] If the SC supports the use of star codes then the AS-SIP EI and SC MUST implement the steps set forth in this requirement and depicted in [Figure 9.5-11](#) in order for the user of an AS-SIP EI to instruct the SC to deactivate call forward busy to another telephone number:

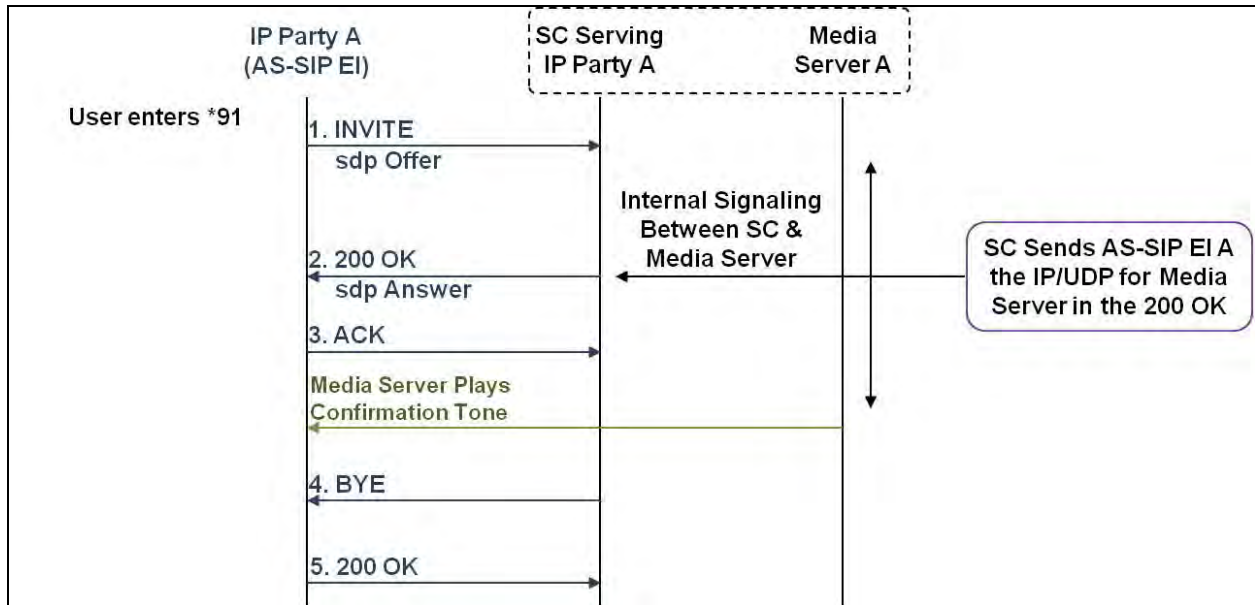

Figure 9.5-11. Call Flow Between AS-SIP EI and SC Using Star Code To Deactivate Call Forward Busy

STEP	INSTRUCTION
1	The user enters *91.
	NOTE: It is permissible for the AS-SIP EI to require a keypad input or other delimiter such as pressing a softkey in order for the user to signal to the AS-SIP EI that the star code is ready to be sent to the SC.
2	The AS-SIP EI sends an INVITE to the SC in which the userinfo part of the Request-URI field is populated with “*91.” The INVITE includes a sdp offer to enable establishment of a bearer between the SC and the AS-SIP EI.
	NOTE 1: The SC and the media server exchange the necessary signaling to provide the media server with the IP address and UDP port provided in the sdp offer by the AS-SIP EI and the media server provides the SC with the IP address and UDP port for the sdp answer to be sent by the SC to the AS-SIP EI in the 200 OK.
	NOTE 2: The media server is considered a part of the SC SUT therefore the signaling between the SC and media server is left to the vendor so long as the confirmation tone is played and the signaling between the SC and AS-SIP EI complies with the specific call flow depicted in this section.
3	The SC sends a 200 response with the sdp answer to the AS-SIP EI. The sdp offer/answer establishes a bearer between the media server and the AS-SIP EI.
4	The AS-SIP EI sends an ACK to the SC.
5	The SC instructs the media server to send a Confirmation tone to the AS-SIP EI. The Confirmation tone MUST conform to the frequency, power and cadence set forth in Table 9.5-1 .
	NOTE: SC MAY instruct media server to send a confirmation tone prior to Step 4 receipt of ACK from AS-SIP EI.
6	The INVITE transaction is terminated upon the occurrence of the first of the following two events:
	a. The user of the AS-SIP EI disconnects ('hangs up') within ten (10) seconds of the commencement of the confirmation tone. The AS-SIP EI sends a BYE and SC responds with a 200 OK, or

STEP	INSTRUCTION
	b. Ten (10) seconds elapse from the commencement of the confirmation tone and the SC does not receive a BYE from the AS-SIP EI. The SC sends a BYE to the AS-SIP EI and the AS-SIP EI responds with a 200 OK.

SIP-006340.a If the SC cannot successfully process the star 91 command received in Step 2 of SIP-006340 then at Step 5 the media server is instructed by the SC to play the reorder tone instead of the confirmation tone. The reorder tone **MUST** conform to the frequency, power and cadence set forth in [Table 9.5-1](#). The INVITE transaction is then completed in accordance with the provisions of Step 6.

Example of Request-URI field of INVITE whose userinfo part is *91:

sip: *91@uc.mil;user=phone

Referring to [Figure 9.5-12](#), IP-to-IP Call Forwarding Busy (AS-SIP EI), assume that at some time before the call request, the user IP Party B at location 1 (i.e., AS-SIP EI B at location 1) has enabled call forwarding busy to IP Party B at location 2 by sending a *90 with the DSN number of location 2 to its SC (i.e., SC for Party B at location 1).

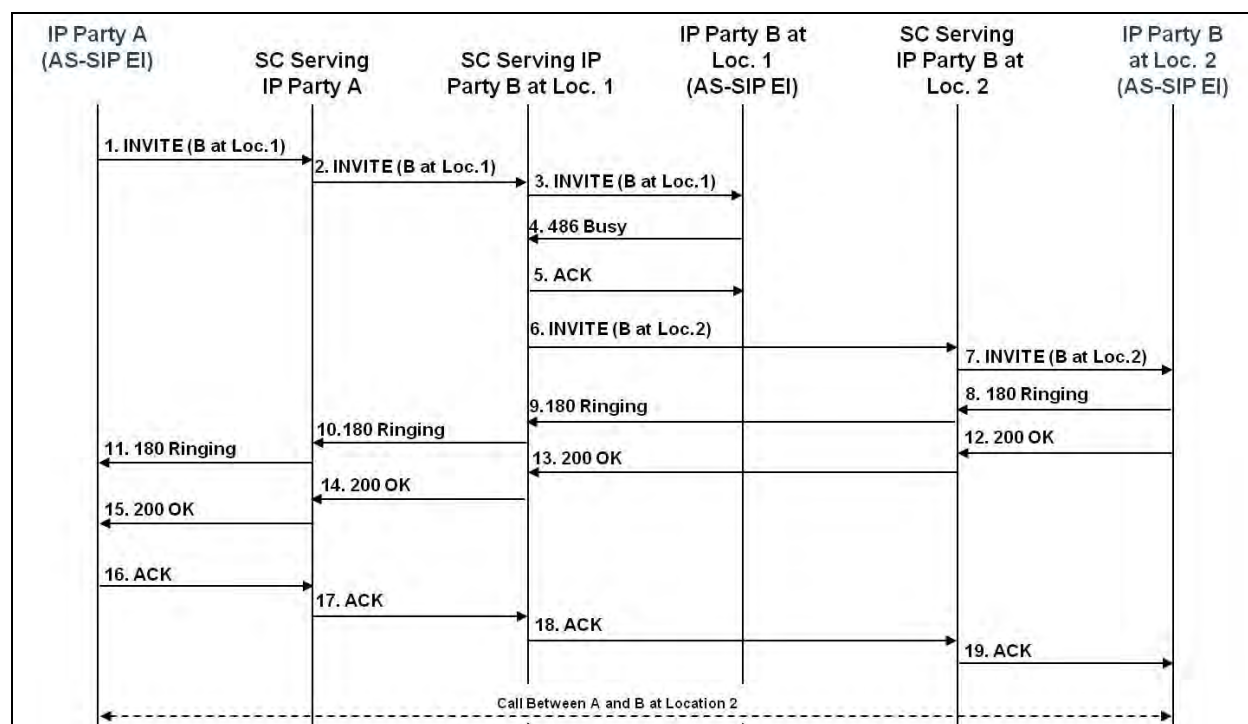

Figure 9.5-12. IP-to-IP Call Forwarding Busy (AS-SIP EI)

AS-SIP EI A sends an INVITE (Step 1) to its SC, which is forwarded to the AS-SIP EI B at location 1 (Step 3). AS-SIP EI B at location 1 responds with a 486 (Busy Here) response (Step 4) to its SC. The SC AS-SIP EI B at location 1 in turn sends an ACK (Step 5) to AS-SIP EI B at location 1, rewrites the Request URI of the original INVITE and sends the INVITE through the network to AS-SIP EI B at location 2 (received by AS-SIP EI B at location 2 in Step 7). AS-SIP

EI B at location 2 responds with a 180 (Ringing) response (Step 8), which is conveyed through the network to AS-SIP EI A (Step 11). When Party B at location 2 goes off-hook, then AS-SIP EI B at location 2 sends a 200 (OK) response (Step 12) across the network to AS-SIP EI A (Step 15). AS-SIP EI A responds with an ACK (Step 16) that is received by AS-SIP EI B at location 2 (Step 19).

The forwarded call is established now between IP Party A and IP Party B at location 2.

9.6 CALL TRANSFER

There are three actors in a given transfer event, each playing one of the following roles:

- Transferee – the party being transferred to the transfer target.
- Transferor – the party initiating the transfer.
- Transfer target – the new party being introduced into a call with the transferee.

The call transfer feature enables the call transferor, who has two calls (one with transferee and one with transfer target), to create either a direct signaling and bearer path between the transferee and the transfer target, or just a direct bearer path between the transferee and transfer target depending on the call flow used to implement the call transfer.

9.6.1 Call Transfer Modes

Call transfer can be operated in two different modes: unattended (blind) and attended (consultation transfer). Blind call transfer will forward the transferee to the new destination without talking to the transfer target. The alternative to this type of call transfer would be consultation transfer, where the call transferor will have a chance to talk to the transfer target before making the transfer.

9.6.2 Unattended Transfer – Call Transferor: SIP

Two methods have been approved for conducting the unattended call transfer:

Method 1: Transferor: The transferor SC uses the REFER request to provide the transferee with the contact information of the transfer target and to instruct the transferee to initiate a session with the transfer target. The call flow is depicted in [Figure 9.6-1](#), Unattended Call Transfer for IP EIs (REFER Method).

Method 2: Transferor: The transferor SC uses re-INVITEs with the transferee and an INVITE with the transfer target in place of the use of the REFER request. The call flow is depicted in [Figure 9.6-2](#), Unattended Call Transfer for IP EIs (INVITE and re-INVITE Method).

9.6.2.1 Unattended Call Transfer for IP EIs (REFER Method)

Figure 9.6-1, Unattended Call Transfer for IP EIs (REFER Method), presents the SIP call flow for the unattended call transfer between a transferor, transferee, and transfer target that are all IP EIs.

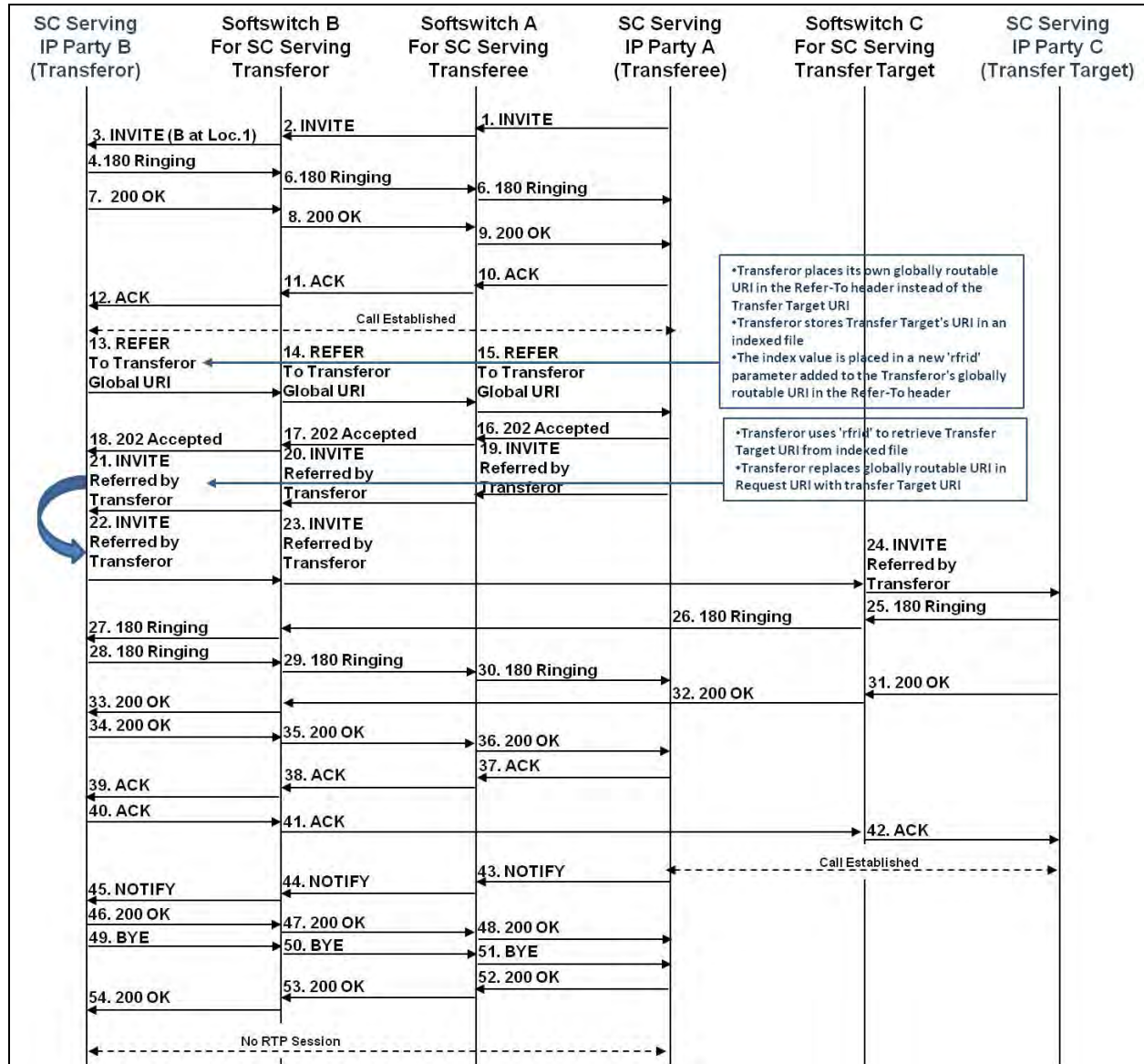

Figure 9.6-1. Unattended Call Transfer for IP EIs (REFER Method)

The basic sequence of events is as follows:

- The transferee and the transferor establish a session.
- The transferor uses the REFER request to provide the transferee with the contact information of the transfer target and to instruct the transferee to initiate a session with the transfer target.

NOTE: The transferor SC substitutes its own globally routable URI for that of the transfer target in the Refer-To header to direct the INVITE generated by the transferee through the transferor SC. The Refer-To header also includes an “rfrid” parameter that is preserved when the transferee creates the INVITE based on the REFER and the “rfrid” parameter is used by the transferor to look up the previously stored URI of the transfer target.

- The transferee acknowledges the REFER request and establishes a session with the transferor.
- The transferee notifies the transferor of the successful establishment of the session between the transferee and the transfer target. The transferor terminates the session with the transferee.

NOTE: [Figure 9.6-1](#) does not depict the call flows between SCs and IP EIs. A summary of the changes to the call flow, when the IP EIs are AS-SIP EIs, is described after both [Figure 9.6-1](#) and the accompanying table describing the unattended call transfer.

ASAC

In [Figure 9.6-1](#), the call flow requires the transferor SC to temporarily allocate three call counts while the unattended transfer is in the process of being established and maintain two call counts from the call count budget for the duration of the call even though no bearer traffic related to the transferred call actually transits the access link to the enclave where the transferor is located. The transferee SC temporarily allocates two call budgets while the unattended transfer is in the process of being established, and then goes back down to one call count for the duration of the call. The transfer target SC allocates one call count.

STEP	INSTRUCTION
1, 2, 3	Upon receiving an initial call request message from IP Party A (transferee) (not depicted in the call flow diagram), the SC serving IP Party A sends an INVITE to its assigned SS (SS A). SS A forwards the INVITE to the SS for the SC serving IP Party B (transferor) (SS B). SS B forwards the INVITE to the SC serving IP Party B (transferor).
	NOTE: Signaling is not depicted between the EI serving IP Party A (transferee) and the SC serving IP Party A (transferee). In addition, signaling is not depicted between the SC serving IP Party B (transferor) and the EI serving IP Party B (transferor).
4, 5, 6	The SC serving IP Party B (transferor) sends a 180 (Ringing) response to SS B. SS B forwards the 180 (Ringing) response to SS A, which forwards the 180 (Ringing) response to the SC serving IP Party A (transferee).
	NOTE: Signaling is not depicted between the transferor’s IP EI and the SC serving the transferor. In addition, signaling is not depicted between the transferee and the transferee’s IP EI.
7, 8, 9	When IP Party B (transferor) goes off-hook (i.e., answers the call), the SC serving IP Party B sends a 200 (OK) response to SS B. SS B forwards the 200 (OK) response to SS A, which forwards the 200 (OK) response to the SC serving IP Party A (transferee).

STEP	INSTRUCTION
	NOTE: Signaling is not depicted between the transferor's IP EI and the SC serving the transferor. In addition, signaling is not depicted between the SC serving the transferee and the transferee's IP EI.
10, 11, 12	The SC serving IP Party A (transferee) sends an ACK to SS A. SS A forwards the ACK to SS B, which forwards the ACK to the SC serving IP Party B (transferor).
	NOTE: Signaling is not depicted between the EI serving IP Party A (transferee) and the SC serving IP Party A (transferee). In addition, signaling is not depicted between the SC serving IP Party B (transferor) and the EI serving IP Party B (transferor).
13, 14, 15	The transferor (IP Party B) wishes to transfer the call to a third party, the transfer target (IP Party C), and instructs the IP EI to initiate a request for a call transfer to the transfer target. In the case of a SIP EI, the message takes the form of a REFER request. In the case of an H.323 or proprietary IP EI, the SC serving the transferor MUST create the REFER request when the transferor signals an intent to transfer the call.
	The transferor SC either receives a REFER request from the transferor EI or generates a REFER request. The transferor SC placed its own globally routable URI into the Refer-To header, stores the number of the transfer target, and adds an "rfrid" parameter to the URI in the Refer-To header. The subsequent INVITE from the transferee to the transferor's globally routable URI will include the "rfrid" parameter and the transferor SC will use the value of the "rfrid" parameter to retrieve the DSN telephone number of the transfer target.
	When IP Party B makes a precedence call request identifying the transfer target, then the transferor SC MAY perform authentication per Requirement SIP-004720.
	If the priority of the call between the transferor and transferee is different from the priority requested by IP Party B for the call with the transfer target then the transferor SC MUST set the priority of the REFER request to the higher priority of the two.
	The SC serving the transferor sends the REFER request to SS B. The REFER request includes a Refer-To header with the SIP URI of the transfer target (IP Party C). The REFER request also MAY include the Referred-By header that contains the SIP URI of the transferor. SS B forwards the REFER request to SS A, which forwards the REFER request to the SC serving IP Party A (transferee).
	NOTE: Signaling is not depicted between the transferor's IP EI and the SC serving the transferor. In addition, signaling is not depicted between the SC serving the transferee and the transferee's IP EI.
16, 17, 18	The SC serving the transferee responds to the REFER request with a 202 (Accepted) response that it sends to SS A. SS A forwards the 202 (Accepted) response to SS B. SS B forwards the 202 (Accepted) response to the SC serving the transferor.
	NOTE: Signaling is not depicted between the transferee's IP EI and the SC serving the transferee. In addition, signaling is not depicted between the SC serving the transferor and the transferor's IP EI.
19, 20, 21	The SC serving the transferee creates (or forwards*) an INVITE using the SIP URI in the Refer-To header of the REFER request (received in Step 15 from the transferor) to generate the Request-URI of the INVITE and includes the "rfrid" parameter.
	NOTE: The Request-URI of the INVITE is addressed to the transferor SC's globally routable URI; not to the transfer target.
	The transferee SC MUST ensure that the priority level in the Resource-Priority header of the INVITE is identical to the priority level of the corresponding REFER received from the transferor SC and MUST correct the priority level if it does not match that of the corresponding REFER.
	The INVITE MAY include a Referred-By header that contains the SIP URI of the transferor.

STEP	INSTRUCTION
	The SC serving the transferee sends the INVITE to SS A. SS A sends the INVITE to SS B, which sends the INVITE to the transferor SC.
	*If the transferee is a SIP EI or AS-SIP EI
22, 23, 24	The transferor SC retrieves the DSN telephone number of the transfer target, removes its globally routable URI from the Request-URI and replaces it with a SIP URI where the userinfo part is the DSN number of the transfer target.
	The transferor SC sends the INVITE to SS B. SS B sends the INVITE to SS C. SS C sends the INVITE to the SC serving IP Party C.
	NOTE: Signaling is not depicted between the transferee's IP EI and the SC serving the transferee. In addition, signaling is not depicted between the SC serving the transfer target and the transfer target's IP EI.
25, 26, 27, 28, 29, 30	The SC serving the transfer target sends a 180 (Ringing) response to SS C. SS C sends a 180 (Ringing) response to SS B. SS B sends a 180 (Ringing) response to the SC serving the transferor. The SC serving the transferor sends the 180 (Ringing) response to SS B, which sends the 180 (Ringing) to SS A, and SS A sends the 180 (Ringing) response to the SC serving the transferee.
	NOTE: Signaling is not depicted between the transfer target's IP EI and the SC serving the transfer target. In addition, signaling is not depicted between the SC serving the transferee and the transferee's IP EI.
31, 32, 33, 34, 35, 36	The SC serving the transfer target sends a 200 (OK) response to SS C. SS C sends a 200 (OK) response to SS B. SS B sends a 200 (OK) response to the SC serving the transferor. The SC serving the transferor sends the 200 (OK) response to SS B, which sends the 200 (OK) response to SS A, and SS A sends the 200 (OK) response to the SC serving the transferee.
	NOTE: Signaling is not depicted between the transfer target's IP EI and the SC serving the transfer target. In addition, signaling is not depicted between the SC serving the transferee and the transferee's IP EI.
37, 38, 39, 40, 41, 42	The SC serving the transferee sends an ACK to SS A. SS A sends the ACK to SS B. SS B sends the ACK to the SC serving the transferee. The SC serving the transferee sends the ACK to SS B, which sends the ACK to SS C and SS C sends the ACK to the SC serving the transfer target.
	NOTE: Signaling is not depicted between the transferee's IP EI and the SC serving the transferee. In addition, signaling is not depicted between the SC serving the transfer target and the transfer target's IP EI.
43, 44, 45	The SC serving the transferee reports the success of the call transfer to the transferor by creating (or forwarding*) a NOTIFY request with a body having the SIP response status line: SIP/2.0 200 OK.
	The SC serving the transferee sends the NOTIFY request to SS A. SS A forwards the NOTIFY request to SS B. SS B forwards the NOTIFY request to the SC serving the transferor.
	NOTE: Signaling is not depicted between the transferee's IP EI and the SC serving the transferee. In addition, signaling is not depicted between the SC serving the transferor and the transferor's IP EI.
	* If the transferee is a SIP EI or AS-SIP EI
46, 47, 48	The SC serving the transferor responds to the NOTIFY request by creating a 200 (OK) response. The SC serving the transferor sends the 200 (OK) response to SS B. SS B sends the 200 (OK) response to SS A. SS A sends the 200 (OK) response to the SC serving the transferee.
	NOTE: Signaling is not depicted between the transferor's IP EI and the SC serving the transferor. In addition, signaling is not depicted between the SC serving the transferee and the transferee's IP EI.

STEP	INSTRUCTION
49, 50, 51	The SC serving the transferor now terminates the RTP session with the transferee. The SC serving the transferor sends a BYE request to SS B. SS B sends the BYE request to SS A. SS A sends the BYE request to the SC serving the transferee.
	NOTE: Signaling is not depicted between the transferor's IP EI and the SC serving the transferor. In addition, signaling is not depicted between the SC serving the transferee and the transferee's IP EI.
52, 53, 54	The SC serving the transferee responds to the BYE request with a 200 (OK) response. The transferee sends the BYE request to SS A. SS A sends the 200 (OK) response to SS B. SS B sends the 200 (OK) response to the SC serving the transferor.
	NOTE: Signaling is not depicted between the transferee's IP EI and the SC serving the transferee. In addition, signaling is not depicted between the SC serving the transferor and the transferor's IP EI.

If the IP EIs are AS-SIP EIs, then the call flow is extended as follows:

- The initial INVITE originates at the transferee AS-SIP EI and is forwarded to the transferor AS-SIP EI (steps 1–3 extended).
- The subsequent 180 (Ringing) and 200 (OK) responses originate at the transferor AS-SIP EI and are forwarded to the transferee AS-SIP EI (steps 4–6 and 7–9 extended).
- The ACK originates at the transferee AS-SIP EI and is forwarded to the transferor AS-SIP EI (steps 10–12 extended).
- The transferor AS-SIP EI generates the REFER request and the REFER is forwarded to the transferee AS-SIP EI (steps 13–15 extended).
- The transferee AS-SIP EI originates and sends the 202 (Accepted) response (steps 16–18 extended).
- The transferee AS-SIP EI creates an INVITE using the SIP URI in the Refer-To header of the REFER request (received from the transferor) to generate the Request-URI of the INVITE for the transfer target and sends the INVITE to the transferor SC globally routable URI, which, in turn, forwards the INVITE to the transfer target AS-SIP EI (steps 19–24 extended).
- The transfer target AS-SIP EI generates and sends the 180 (Ringing) and 200 (OK) responses to the transferee AS-SIP EI (steps 25–30 and steps 31–36 extended).
- The transferee AS-SIP EI responds with an ACK that is forwarded to the transfer target AS-SIP EI (steps 37–42 extended).
- The transferee AS-SIP EI sends a NOTIFY request with a body having the SIP response status line: SIP/2.0 200 OK to the transferor AS-SIP EI (steps 43–45 extended).
- The transferor AS-SIP EI responds with a 200 (OK) response to the NOTIFY request, which it sends to the transferee AS-SIP EI (steps 46–48 extended).
- The transferor AS-SIP EI originates and sends the BYE request to the transferee AS-SIP EI (steps 49–51 extended).

- The transferee AS-SIP EI responds with the 200 (OK) response to the BYE request and sends it to the transferor AS-SIP EI (steps 52–54 extended).

9.6.2.2 Unattended Call Transfer for IP EIs (INVITE and re-INVITE Method)

[Figure 9.6-2](#), Unattended Call Transfer for IP EIs (INVITE and re-INVITE Method), presents an alternative SIP call flow for the unattended call transfer between a transferor, transferee, and transfer target that makes use of re-INVITES and INVITES (as opposed to the REFER request).

The basic sequence of events is as follows:

- The transferee and the transferor establish a session.
- The transferor places the session with the transferee on hold (music on hold is optional).
- The user served by the transferor’s SC makes a call transfer request intended for the transfer target and the transferor SC initiates the session establishment process with the transfer target (sends the INVITE and receives a 180 (Ringing) response).

NOTE: In the case of a precedence call transfer request, the transferor SC MAY perform authentication of the user per Requirement SIP-004720.

NOTE: If the user requests a call transfer with the transfer target where the priority is lower than the priority of the existing call between the transferee and transferor, then the transferor SC MUST place the higher priority value (from the transferee-transferor session) into the Resource-Priority header of the INVITE to the transfer target.

NOTE: If the priority of the call request to the transfer target is greater than the priority of the existing call between the transferee and transferor, then the transferor SC MUST set the priority of the Resource-Priority header in all the following UPDATES and re-INVITES that it sends to the transferee at the higher priority level (of the call being initiated to the transfer target).

- The transferor SC updates the connected party information with the transferee to reflect the identity of the transfer target.
- The transferor SC stops the music on hold if previously enabled and inserts ringback tone into bearer stream with the transferee.
- The transferor SC receives a 200 (OK) response from the transfer target and stops playing the ringback tone to the transferee.
- The transferor SC uses a re-INVITE with the transferee to provide the transferee with the transfer target’s IP address and udp port for the RTP bearer stream between the transferee and the transfer target.

- The transferor completes the session establishment with the transfer target and provides the transfer target with the transferee's IP address and udp port for the RTP stream between the transfer target and the transferee.

NOTE: The call flows are not depicted between SCs and the IP EIs.

NOTE: [Figure 9.6-2](#) does not depict the call flows between SCs and IP EIs.

ASAC

In [Figure 9.6-2](#), Unattended Call Transfer for IP EIs (INVITE and re-INVITE Method), the call flow requires the transferor SC to allocate two call counts from the call count budget for the duration of the call even though no bearer traffic related to the given call actually transits the access link to the enclave where the transferor is located. The transferee SC and the transfer target SC each allocates one call count.

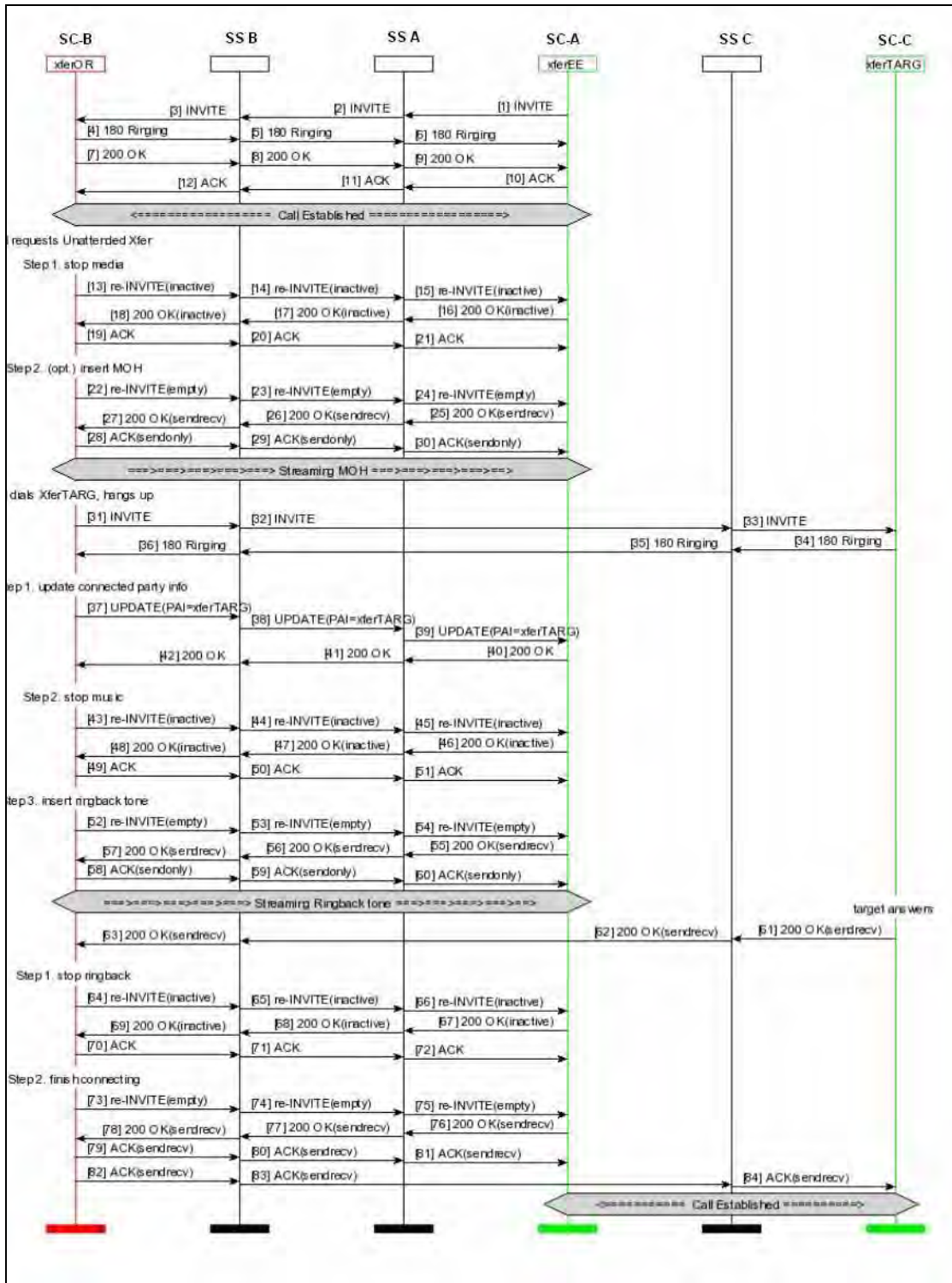

Figure 9.6-2. Unattended Call Transfer for IP EIs (INVITE and re-INVITE Method)

9.6.3 Attended Transfer – Call Transferor: SIP

Two methods have been approved for conducting the attended call transfer: The first method makes use of the REFER with the Replaces method and the second makes use of INVITEs and re INVITEs.

9.6.3.1 Attended Call Transfer for IP EIs (REFER Method)

[Figure 9.6-3](#), Attended Call Transfer for IP EIs (REFER Method), presents the SIP call flow for the attended call transfer (using the REFER with the Replaces method) between a transferor, transferee, and transfer target that are all IP EIs. The call flow is loosely based on ETSI TS 183 029 V2.5.0, Telecommunications and Internet Converged Services and Protocols for Advanced Networking (TISPAN); PSTN/ISDN simulation services: Explicit Communication Transfer (ECT); Protocol specification.

The basic sequence of events is as follows:

- The transferee and the transferor establish a session.
- The transferor places the session with the transferee on hold (music on hold is optional).
- The transferor establishes a session with the transfer target.
- The transferor places the session with the transfer target on hold (music on hold is optional).
- The transferor then proceeds with the creation of a REFER request intended for the transferee. Normally, the URI of the transfer target would be used by the transferor SC to populate the Refer-To URI field. However, to enable the successful completion of the attended call transfer using the REFER with the Replaces method, it is necessary to keep the transferor SC in the signaling path of the REFER-triggered INVITE. As a result, the transferor SC inserts its own globally routable URI into the Refer-To header. The transferor SC places the Call-ID, to-tag, and from-tag information for the target dialog (from the perspective of the transferor) in a single, fully escaped the Replaces header field, which is inserted into the Refer-To header (see the example following the figure). Then the REFER is forwarded downstream toward the transferee.

NOTE: The transferor SC stores the actual transfer target URI in an indexed file and the index entry is placed in a new “rfrid” URI parameter that is inserted into the userinfo field of the Refer-To URI as follows:

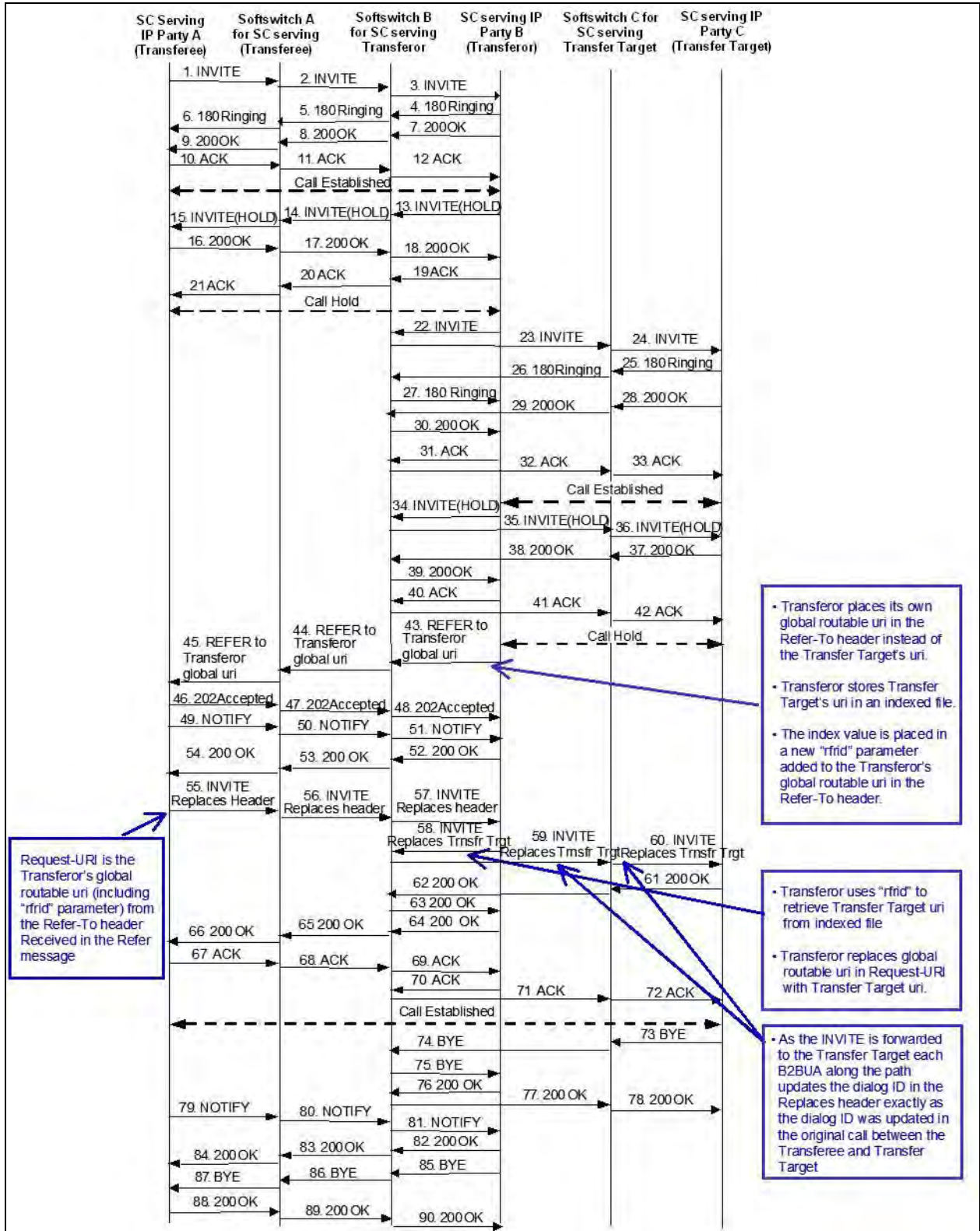

Figure 9.6-3. Attended Call Transfer for IP EIs (REFER Method)

Example:

Refer-
To:<sip:3121000000;rfrid=123456@uc.mil;user=phone>;Replaces=59243588173
4450904%3Bto-tag%3D9m2n3wq%3Bfrom-tag3D763231

- The transferee accepts or acknowledges the REFER request.
- The transferee attempts to establish a session by sending an INVITE request to the contact identified in the Refer-To header. The INVITE request includes a single Replaces header field value (i.e., the un-escaped Replaces header field value from the Refer-To header within the body of the REFER request, which triggered the corresponding INVITE request).

NOTE: Now the transferor SC is permanently in the signaling path between the transferee and transfer target until the transferred call between the transferee and the transfer target is eventually terminated.

- The Transferor SC receives the INVITE request. It uses the “rfrid” value to look up and retrieve the actual transfer target URI. The transferor SC replaces its globally routable URI in the Request-URI with the actual transfer target URI and forwards the INVITE request toward the transfer target.
- As the INVITE request is forwarded from the transferor SC to the transfer target, the dialog ID value in the Replaces header is “updated” (mapped to the dialog ID value of a corresponding “call leg” as recognized by each signaling appliance along the signaling path) on each hop along the signaling path.
- After successfully establishing a session with the transferee, the transfer target ends the session with the transferor.
- The transferee notifies the transferor of the successful establishment of the session between the transferee and the transfer target.
- The transferor ends the session with the transferee.

NOTE: [Figure 9.6-3](#), Attended Call Transfer for IP EIs (REFER Method), does not depict the call flows between SCs and the IP EIs. A summary of the changes to the call, if the IP EIs were AS-SIP EIs, is described after [Figure 9.6-3](#) and the accompanying table describing the attended call transfer.

ASAC

In [Figure 9.6-3](#), Attended Call Transfer for IP EIs (REFER Method), the call flow requires the transferor SC to allocate four call counts temporarily while the attended transfer is in the process of being established and to allocate two call counts from the call count budget for the duration of the call even though no bearer traffic related to the given call actually transits the access link to the enclave where the transferor is located. The transferee SC temporarily allocates two call budgets while the attended transfer is in the process of being established, and then again goes

down to one call count for the duration of the call. The transfer target SC temporarily allocates two call budgets while the attended transfer is in the process of being established, and then again goes down to one call count for the duration of the call.

STEP	INSTRUCTION
1, 2, 3	Upon receiving an initial call request message from IP Party A (transferee) (not depicted in the call flow diagram), the SC serving IP Party A sends an INVITE to its assigned SS (SS A). SS A forwards the INVITE to the SS for the SC serving IP Party B (transferor) (SS B). SS B forwards the INVITE to the SC serving IP Party B (transferor).
	NOTE: Signaling is not depicted between the EI serving IP Party A (transferee) and the SC serving IP Party A (transferee). In addition, signaling is not depicted between the SC serving IP Party B (transferor) and the EI serving IP Party B (transferor).
4, 5, 6	The SC serving IP Party B (transferor) sends a 180 (Ringing) response to SS B. SS B forwards the 180 (Ringing) response to SS A, which forwards the 180 (Ringing) response to the SC serving IP Party A (transferee).
	NOTE: Signaling is not depicted between the EI serving IP Party B (transferor) and the SC serving IP Party B (transferor). In addition, signaling is not depicted between the SC serving IP Party A (transferee) and the EI serving IP Party A (transferee).
7, 8, 9	When IP Party B (transferor) goes off-hook (i.e., answers the call), the SC serving IP Party B sends a 200 (OK) response to SS B. SS B forwards the 200 (OK) response to SS A, which forwards the 200 (OK) response to the SC serving IP Party A (transferee).
	NOTE: Signaling is not depicted between the EI serving IP Party B (transferor) and the SC serving IP Party B (transferor). In addition, signaling is not depicted between the SC serving IP Party A (transferee) and the EI serving IP Party A (transferee).
10, 11, 12	The SC serving IP Party A (transferee) sends an ACK to SS A. SS A forwards the ACK to SS B, which forwards the ACK to the SC serving IP Party B (transferor).
	NOTE: Signaling is not depicted between the EI serving IP Party A (transferee) and the SC serving IP Party A. In addition, signaling is not depicted between the SC serving IP Party B and the EI serving IP Party B (transferor).
13, 14, 15	The transferor initiates a call hold with the transferee.
	In response to a request on the part of the transferor, the SC serving the transferor sends a mid-call INVITE to SS B. The INVITE includes the attribute line “a=sendonly” or “a=inactive” if the stream had been a sendrecv media stream, or “a=inactive” if the stream had been a recvonly stream. SS B forwards the mid-call INVITE to SS A, which forwards the mid-call INVITE to the SC serving the transferee.
	NOTE: The SIP UA MAY also support establishing a call hold by sending a mid-call INVITE that includes a session description that is the same as in the original request, but the “c” destination addresses for the media streams to be put on hold are set to zero: c=IN IP4 0.0.0.0. NOTE: Signaling is not depicted between the transferor’s EI and the SC serving the transferor. In addition, signaling is not depicted between the SC serving the transferee and the EI serving the transferee.
16, 17, 18	The SC serving the transferee sends a 200 (OK) response to SS A. SS A sends the 200 (OK) response to SS B. SS B sends the 200 (OK) response to the SC serving the transferor.
	NOTE: Signaling is not depicted between the transferee’s EI and the SC serving the transferee. In addition, signaling is not depicted between the SC serving the transferor and the EI serving the transferor.

STEP	INSTRUCTION
19, 20, 21	The SC serving the transferor sends an ACK to SS B. SS B sends an ACK to SS A. SS A sends the ACK to the SC serving the transferee.
	NOTE: Signaling is not depicted between the transferor's EI and the SC serving the transferor. In addition, signaling is not depicted between the SC serving the transferee and the EI serving the transferee.
22, 23, 24	Upon receiving a call request message from the transferor (not depicted in the call flow diagram), the SC serving the transferor sends an INVITE to SS B.
	NOTE: When the user (transferor) initiates a precedence call request intended for the transfer target, then the transferor SC MAY performs authentication per Requirement SIP-004720).
	SS B forwards the INVITE to the SS C (which is responsible for the SC serving the transfer target.) SS C forwards the INVITE to the SC serving the transfer target (IP Party C).
	NOTE: Signaling is not depicted between the IP EI serving the transferor and the SC serving the transferor. In addition, signaling is not depicted between the SC serving the transfer target and the IP EI serving the transfer target.
25, 26, 27	The SC serving the transfer target sends a 180 (Ringing) response to SS C. SS C forwards the 180 (Ringing) response to SS B, which forwards the 180 (Ringing) response to the SC serving the transferor.
	NOTE: Signaling is not depicted between the IP EI serving the transfer target and the SC serving the transfer target. In addition, signaling is not depicted between the SC serving the transferor and the IP EI serving the transferor.
28, 29, 30	When the transfer target goes off-hook (i.e., answers the call), the SC serving the transfer target sends a 200 (OK) response to SS C. SS C forwards the 200 (OK) response to SS B, which forwards the 200 (OK) response to the SC serving the transferor.
	NOTE: Signaling is not depicted between the EI serving IP Party C (transfer target) and the SC serving the transfer target. In addition, signaling is not depicted between the SC serving IP Party A (transferor) and the EI serving IP Party A (transferor).
31, 32, 33	The SC serving IP Party B (transferor) sends an ACK to SS B. SS B forwards the ACK to SS C, which forwards the ACK to the SC serving IP Party C (transfer target).
	NOTE: Signaling is not depicted between the EI serving IP Party B (transferor) and the SC serving IP Party B (transferor). In addition, signaling is not depicted between the SC serving IP Party C (transfer target) and the EI serving IP Party C (transfer target).
34, 35, 36	The transferor initiates a call hold with the transfer target.
	In response to a request on the part of the transferor, the SC serving the transferor sends a mid-call INVITE to SS B. The INVITE includes the attribute line "a=sendonly" or "a=inactive" if the stream had been a sendrecv media stream, or "a=inactive" if the stream had been a recvonly stream. SS B forwards the mid-call INVITE to SS C, which forwards the mid-call INVITE to the SC serving the transfer target.
	NOTE: The SIP UA also MAY support establishing a call hold by sending a mid-call INVITE that includes a session description that is the same as in the original request, but the "c" destination addresses for the media streams to be put on hold are set to zero: c=IN IP4 0.0.0.0.
	NOTE: Signaling is not depicted between the transferor's EI and the SC serving the transferor. In addition, signaling is not depicted between the SC serving the transfer target and the EI serving the transfer target.

STEP	INSTRUCTION
37, 38, 39	The SC serving the transfer target sends a 200 (OK) response to SS C. SS C sends the 200 (OK) response to SS B. SS B sends the 200 (OK) response to the SC serving the transferor.
	NOTE: Signaling is not depicted between the transfer target's EI and the SC serving the transfer target. In addition, signaling is not depicted between the SC serving the transferor and the EI serving the transferor.
40, 41, 42	The SC serving the transferor sends an ACK to SS B. SS B sends an ACK to SS C. SS C sends the ACK to the SC serving the transfer target.
	NOTE: Signaling is not depicted between the transferor's EI and the SC serving the transferor. In addition, signaling is not depicted between the SC serving the transfer target and the EI serving the transfer target.
43, 44, 45	The transferor (IP Party B) wishes to transfer the call with the transferee (IP Party A) to the transfer target (IP Party C) and instructs the IP EI to initiate a request for a call transfer to the transfer target. In the case of an attended call transfer and a SIP EI, the message takes the form of a REFER request where the Refer-To header has the format indicated in RFC 3515, page 3, example 3. To wit, the SIP URI of the transfer target is followed by "?," followed by "Replaces=" followed by the Call ID of the established dialog between the transferor and the Transfer target (where the "@" symbol is replaced by "%40"), followed by "%3Bto-tag=%3D," followed by the value of the to-tag of the dialog between the transferor and the transfer target, followed by "%3Bfrom-tag=%3D," followed by the value of the from-tag of the dialog between the transferor and the transfer target. (For an example, please see draft-ietf-sipping-service-examples, Section 2.5, Transfer Attended Message F15).
	Upon generating the REFER or receiving the REFER from a served AS-SIP EI or SIP EI, the transferor SC stores the transfer target's uri in an indexed file.
	The transferor SC places its own global routable uri in the Refer-To header.
	The transferor SC places the index value (used to access the transfer target URI in the indexed file) in a new "rfrid" parameter added to the transferor SC's globally routable URI in the Refer-To header.
	If the Call ID, to-tag, or from-tag used by the transferor SC in the established call to the transfer target is different from the values entered by the transferor SIP EI, then the transferor SC places its values for the Call-ID, to tag, and from tag in the Replaces field of the Refer-To header.
	If the priority of the call between the transferor and transferee is different from the priority of the call between the transferor and the transfer target, then the transferor SC MUST set the priority in the Resource-Priority header of the REFER request to the higher priority level.
	The transferor SC sends the REFER request to SS B. SS B forwards the REFER request to SS A. SS A sends the REFER request to the SC serving IP Party A (the transferee SC).
	NOTE: All AS-SIP signaling appliances in the signaling path from the transferor SC through the transferee SC must preserve the entire URI including the "rfrid" parameter located in the Refer-To header.
46, 47, 48	The SC serving the transferee responds to the REFER request with a 202 (Accepted) response that it sends to SS A. SS A forwards the 202 response to SS B. SS B forwards the 202 response to the SC serving the transferor.
	NOTE: Signaling is not depicted between the transferee's IP EI and the SC serving the transferee. In addition, signaling is not depicted between the SC serving the transferor and the transferor's IP EI.
49, 50, 51	The SC serving the transferee creates (or forwards*) a NOTIFY request with a body having the SIP response status line: SIP/2.0 100 Trying. The SC serving the transferee sends the NOTIFY request to SS A. SS A forwards the NOTIFY request to SS B. SS B forwards the NOTIFY request to the SC serving the transferor.

STEP	INSTRUCTION
	NOTE: Signaling is not depicted between the transferee's IP EI and the SC serving the transferee. In addition, signaling is not depicted between the SC serving the transferor and the transferor's IP EI.
	*If the transferee uses a SIP EI
52, 53, 54	The SC serving the transferor sends a 200 (OK) response to the NOTIFY request to SS B. SS B forwards the 200 (OK) response to SS A, which forwards the 200 (OK) response to the SC serving the transferee.
	NOTE: Signaling is not depicted between the transferor's IP EI and the SC serving the transferor. In addition, signaling is not depicted between the SC serving the transferee and the transferee's IP EI.
55, 56, 57	The SC serving the transferee creates (or forwards*) an INVITE addressed to the transferor SC's globally routable URI. The Request-URI field is the SIP URI from the Refer-To header of the REFER request (Step 45) that consists of the globally routable URI of the transferor SC and the "rfrid" parameter. The INVITE request also includes a Replaces header with a Call-ID, to-tag, and from-tag where their values are taken from the Refer-To header of the REFER request (Step 45). The SC serving IP Party A sends an INVITE request to SS A, which forwards the INVITE request to SS B, which forwards the INVITE request to the SC serving IP Party B (i.e., transferor SC).
	The transferee SC MUST ensure that the priority level in the Resource-Priority header of the INVITE request is identical to the priority level of the corresponding REFER request received from the transferor's SC and MUST correct the priority level if it does not match that of the corresponding REFER request.
	NOTE: Signaling is not depicted between the transferee's IP EI and the SC serving the transferee.
	*If the transferee uses a SIP EI
58, 59, 60	The transferor's SC uses value in the "rfrid" parameter to retrieve the transfer target URI.
	The transferor's SC replaces its global routable URI in the Request-URI with the transfer target URI.
	As the INVITE request is forwarded from the transferor's SC to the transfer target various AS-SIP signaling appliances implemented as B2BUAs will need to update the dialog ID in the Replaces header to match the dialog ID changes made across call legs to the established call between the transferor and the transfer target.
	The transferor's SC sends the INVITE request to SS B, which sends the INVITE request to SS C, which sends the INVITE request to the SC serving IP Party C.
	NOTE: Signaling is not depicted between the SC serving the transfer target and the transfer target's IP EI.
61, 62, 63, 64, 65, 66	The SC serving the transfer target sends a 200 (OK) response to SS C. It forwards the 200 (OK) response to SS B, which forwards the 200 (OK) response to the SC serving the transferor, which forwards the 200 (OK) response back to SS B, which forwards the 200 (OK) response to SS A, which forwards the 200 (OK) response to the SC serving the transferee.
	NOTE: Signaling is not depicted between the transfer target's IP EI and the SC serving the transfer target. In addition, signaling is not depicted between the SC serving the transferee and the transferee's IP EI.
67, 68, 69, 70, 71, 72	The SC serving the transferee sends an ACK to SS A. SS A sends the ACK to SS B. SS B sends the ACK to the SC serving the transferor. The SC serving the transferor sends the ACK back to SS B. SS B sends the ACK to SS C. SS C sends the ACK to the SC serving the transfer target.

STEP	INSTRUCTION
	NOTE: Signaling is not depicted between the transferee's IP EI and the SC serving the transferee. In addition, signaling is not depicted between the SC serving the transfer target and the transfer target's IP EI.
73, 74, 75	The transfer target terminates the session with the transferor.
	The SC serving the transfer target sends a BYE request to SS C. It sends the BYE request to SS A, which sends the BYE request to the SC serving the transferor.
	NOTE: Signaling is not depicted between the transfer target's IP EI and the SC serving the transfer target. In addition, signaling is not depicted between the SC serving the transferor and the transferor's IP EI.
76, 77, 78	The SC serving the transferor sends a 200 (OK) response to SS A. It sends a 200 (OK) response to SS C, which sends a 200 (OK) response to the SC serving the transfer target.
	NOTE: Signaling is not depicted between the transferor's IP EI and the SC serving the transferor. In addition, signaling is not depicted between the SC serving the transfer target and the transfer target's IP EI.
79, 80, 81	The SC serving the transferee reports the success of the call transfer to the transferor by creating (or forwarding*) a NOTIFY request with a body having the SIP response status line: SIP/2.0 200 OK. The SC serving the transferee sends the NOTIFY request to SS A. It forwards the NOTIFY request to SS B, which forwards the NOTIFY request to the SC serving the transferor.
	NOTE: Signaling is not depicted between the transferee's IP EI and the SC serving the transferee. In addition, signaling is not depicted between the SC serving the transferor and the transferor's IP EI.
	*If the transferee uses a SIP EI
82, 83, 84	The SC serving the transferor responds to the NOTIFY request with a 200 (OK) response. The SC serving the transferor sends the 200 (OK) response to SS B. It sends the 200 (OK) response to SS A, which sends the 200 (OK) response to the SC serving the transferee.
	NOTE: Signaling is not depicted between the transferor's IP EI and the SC serving the transferor. In addition, signaling is not depicted between the SC serving the transferee and the transferee's IP EI.
85, 86, 87	The SC serving the transferor sends a BYE request to SS B to initiate the session termination between the transferor and the transferee. SS B sends the BYE request to SS A. It sends the BYE request to the SC serving the transferee.
	NOTE: Signaling is not depicted between the transferor's IP EI and the SC serving the transferor. In addition, signaling is not depicted between the SC serving the transferee and the transferee's IP EI.
88, 89, 90	The SC serving the transferee responds to the BYE request with a 200 (OK) response.
	The SC serving the transferee sends the 200 (OK) response to SS A. It sends the 200 (OK) response to SS B, which sends the 200 (OK) response to the SC serving the transferor.
	NOTE: Signaling is not depicted between the transferee's EI and the SC serving the transferee. In addition, signaling is not depicted between the SC serving the transferor and the transferor's IP EI.

If the IP EIs are AS-SIP EIs, then the call flow is extended as follows:

- The initial INVITE request originates at the transferee's AS-SIP EI and is forwarded to the transferor's AS-SIP EI (steps 1–3 extended).

- The subsequent 180 (Ringing) and 200 (OK) responses originate at the transferor's AS-SIP EI and are forwarded to the transferee's AS-SIP EI (steps 4–6 and 7–9 extended).
- The ACK originates at the transferee's AS-SIP EI and is forwarded to the transferor's AS-SIP EI (steps 10–12 extended).
- The transferor's AS-SIP EI sends a re-INVITE request to the transferee's AS-SIP EI to place the call on hold (steps 13–15 extended).
- The transferee's AS-SIP EI responds with a 200 (OK) response that is forwarded to the transferor's AS-SIP EI (steps 16–18 extended).
- The transferor's AS-SIP EI sends an ACK to the transferee's AS-SIP EI and is forwarded to the transferor's AS-SIP EI (steps 19–21 extended).
- The transferor's AS-SIP EI sends an INVITE request to the transfer target's AS-SIP EI (steps 22–24 extended).
- The subsequent 180 (Ringing) and 200 (OK) responses originate at the transfer target's AS-SIP EI and are forwarded to the transferor's AS-SIP EI (steps 25–27 and 28–30 extended).
- The ACK originates at the transferor's AS-SIP EI and is forwarded to the transfer target's AS-SIP EI (steps 31–33 extended).
- The transferor's AS-SIP EI sends a re-INVITE request to the transfer target's AS-SIP EI to place the call on hold (steps 34–36 extended).
- The transfer target's AS-SIP EI responds with a 200 (OK) response that is forwarded to the transferor's AS-SIP EI (steps 37–39 extended).
- The transferor's AS-SIP EI sends an ACK to the transfer target's AS-SIP EI and is forwarded to the transferor's AS-SIP EI (steps 40–42 extended).
- The transferor's AS-SIP EI generates a REFER request where the Refer-To header has the format indicated in RFC 3515, page 3, example 3 (in the previous table, see steps 43–45) (Step 43 extended). Upon receiving the REFER request, the transferor's SC stores the transfer target's uri in an indexed file, places its own global routable uri in the Refer-To header, places the index value (used to access the transfer target's URI in the indexed file) in a new "rfrid" parameter that is added to its globally routable URI in the Refer-To header (If the Call-ID, to-tag, or from-tag used by the transferor's SC in the established call to the transfer target is different from the values entered by the transferor's AS-SIP EI, then the transferor's SC places its values for Call-ID, to-tag, and from-tag in the Replaces field of the Refer-To header.) (Step 43). The REFER request is forwarded to the transferee's AS-SIP EI (steps 44 and 45 extended).

NOTE: The transferee's SC and the transferee's AS-SIP EI must preserve the entire URI including the "rfrid" parameter located in the Refer-To header.

- The transferee's AS-SIP EI sends a 202 (Accepted) response and a NOTIFY request to the transferor's AS-SIP EI (steps 46–48 and steps 49–51 extended).

- The transferor's AS-SIP EI responds to the NOTIFY request by sending a 200 (OK) response to the transferee's AS-SIP EI (steps 52–54 extended).
- The transferee's AS-SIP EI creates an INVITE with a Replaces header addressed to the transferor's SC globally routable URI. The Request-URI field is the SIP URI from the Refer-To header of the REFER request (Step 45) that consists of the globally routable URI of the transferor's SC and the "rfrid" parameter (steps 55–57 extended).
- The transferor SC uses value in "rfrid" parameter to retrieve the transfer target's URI and replaces its globally routable URI in the Request-URI with the transfer target's URI. Then the transferor's SC sends an INVITE request to the transfer target's UC SP EI (steps 58–60 extended).
- The transfer target's AS-SIP EI responds with 200 (OK) response to the transferee's AS-SIP EI (steps 61–66 extended).
- The transferee's AS-SIP EI sends an ACK to the transfer target's AS-SIP EI (steps 67–72 extended).
- The transfer target's AS-SIP EI ends the session with the transferor's AS-SIP EI by sending a BYE request (steps 73–75 extended).
- The transferor's AS-SIP EI responds with a 200 (OK) response to the transfer target's AS-SIP EI (steps 76–78 extended).
- The transferee's AS-SIP EI notifies the transferor's AS-SIP EI of a successful transfer by sending a NOTIFY request (steps 79–81 extended).
- The transferor's AS-SIP EI responds with 200 (OK) response to the transferee's AS-SIP EI (steps 82–84 extended).
- The transferor's AS-SIP EI terminates the session with the transferee's AS-SIP EI by sending a BYE request (steps 85–87 extended).
- The transferee's AS-SIP EI responds with 200 (OK) response to the transferor's AS-SIP EI (steps 88–90 extended).

9.6.3.2 Attended Call Transfer for IP EI (INVITE and re-INVITE Method)

[Figure 9.6-4](#), Attended Call Transfer for IP EI (INVITE and re-INVITE Method), presents an alternative SIP call flow for the attended call transfer between a transferor, transferee, and transfer target that makes use of INVITE and re-INVITE requests (as opposed to the REFER request and an INVITE request with a Replaces header).

The basic sequence of events is as follows:

- The transferee and the transferor establish a session.
- The transferor places the session with the transferee on hold (music on hold is optional).
- The transferor and the transfer target establish a session.

NOTE: In the case of a precedence call transfer request, the transferor's SC MAY perform authentication of the user per Requirement SIP-004720.

- The transferor stops the music on hold with the transferee, if previously enabled, and places the call on hold without media.
- The transferor places the call with the transfer target on hold (music on hold is optional).

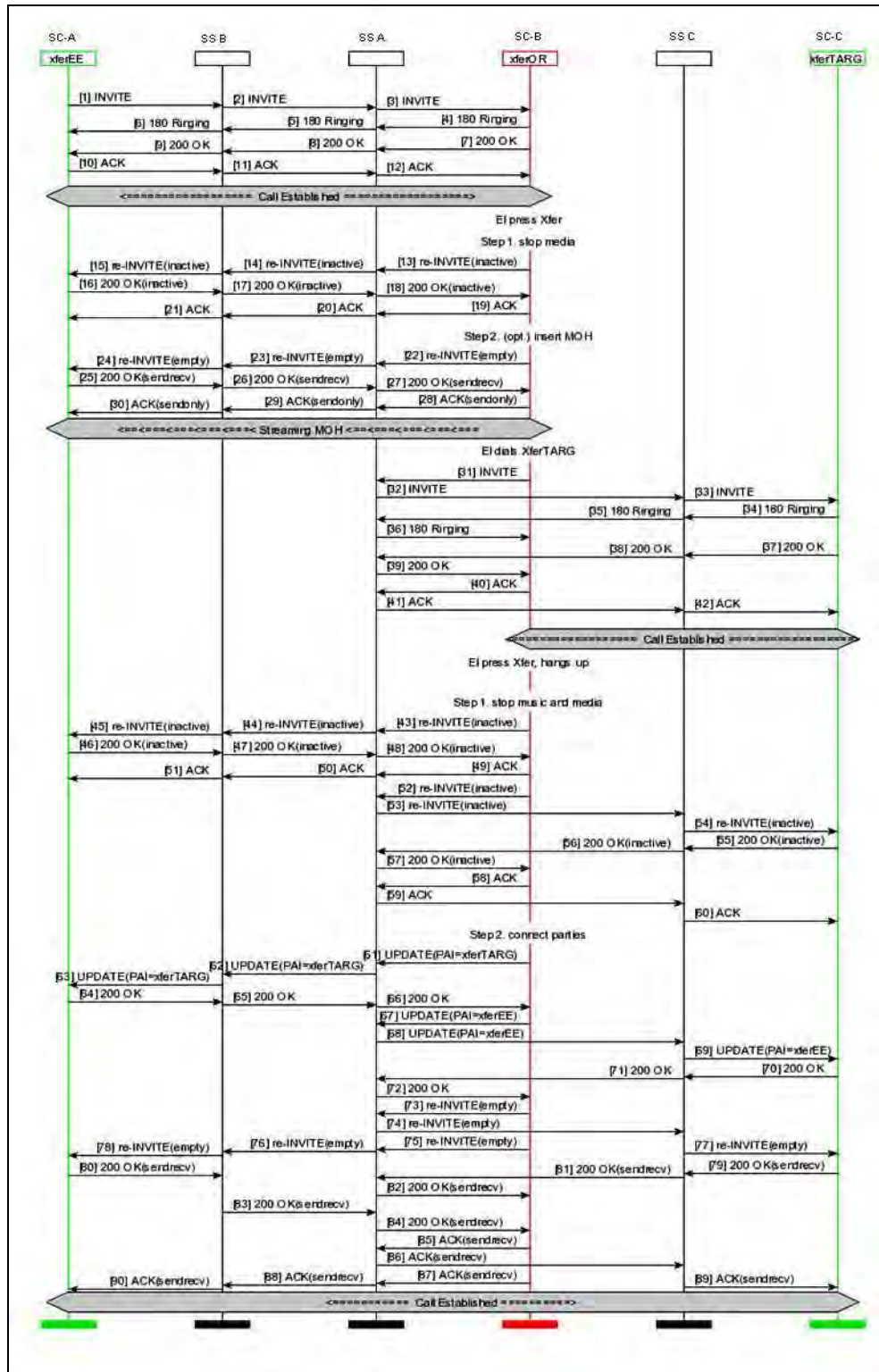

Figure 9.6-4. Attended Call Transfer for IP EI (INVITE and re-INVITE Method)

- The transferor updates the connected party information with the transferee to reflect the identity of the transfer target.
- The transferor updates the connected party information with the transfer target to reflect the identity of the transferee.
- The transferor initiates a re-INVITE request with the transferee to obtain an IP address and udp port to be provided to the transfer target and initiates a separate re-INVITE request with the transfer target to obtain an IP address and udp port for the bearer stream to provide to the transferee.

NOTE: If the user requests a call transfer in which the priority of the call between the transferor and transfer target is lower than the priority of the existing call between the transferee and transferor, then the transferor LSC MUST place the higher priority value (from the transferee-transferor session) into the Resource-Priority header of all the following UPDATES and re-INVITES that it sends to the transfer target.

NOTE: If the user requests a call transfer in which the priority of the call between the transferor and transfer target is greater than the priority of the existing call between the transferee and transferor, then the transferor SC MUST place the higher priority value (from the transferor-transfer target session) into the Resource-Priority header in all the following UPDATES and re-INVITES that it sends to the transferee.

- The transferor provides the transferee with the IP address and udp port information obtained from the transfer target when the transferor sends the sdp answer to the transferee (ACK request 87, 88, 90).
- The transferor provides the transfer target with the IP address and udp port information obtained from the transferee when the transferor sends the sdp answer to the transfer target (ACK request 85, 86, 89).

NOTE: The call flows are not depicted between SCs and the IP EIs.

ASAC

In [Figure 9.6-4](#), Attended Call Transfer for IP EI (INVITE and re-INVITE Method), the call flow requires the transferor's SC to allocate two call counts from the call count budget for the duration of the call even though no bearer traffic related to the given call actually transits the access link to the enclave where the transferor is located.

9.7 THREE-WAY AUDIO CALL

Three-way audio calls can be performed at an EI (see [Section 15.1](#)) or at an audio conference server in the form of an ad hoc conference consisting of 3 participants (see [Section 10.2.1](#)) or at a

SC serving a proprietary EI that is making the three-way call request (analogous to PBX three-way call support for server EIs) (see [Section 15.2](#)).

9.7.1 Three-Way Audio Call Performed by EI

9.7.1.1 Precedence and Preemption Rule for Three-Way Audio Calls at EI

SIP-006350 When the call legs in a three-way call have different priority levels, the EI does NOT adjust the priority level of the lower priority call leg to match the precedence of the higher priority call leg.

SIP-006360 Whenever an ~~EI (either AS-SIP EI with P&P or a proprietary EI)~~ is the focus for a three-way call and ~~if~~ the user of the EI goes on-hook pursuant to receipt of a preemption tone then the other 2 participants MUST be disconnected from three-way call.⁸⁷

NOTE: As a general matter, whenever the user of an EI that is the focus for a three-way call terminates participation in the call then the other 2 participants MUST be disconnected from the call.

[Figure 9.7-1](#) depicts the call flow for an endpoint preemption at AS-SIP EI B that is the focus for a three-way call that includes AS-SIP EI A and AS-SIP EI C.

⁸⁷ The RO AS-SIPEI does not play the preemption tone so the user at an RO AS-SIP EI that is the focus of a three-way call cannot go on-hook pursuant to receipt of a preemption tone. However, the RO AS-SIP EI can be the focus for a three-way call and if the user of the RO AS-SIP EI (that is the focus for a three-way call) terminates participation in the call then the other 2 participants must be disconnected.

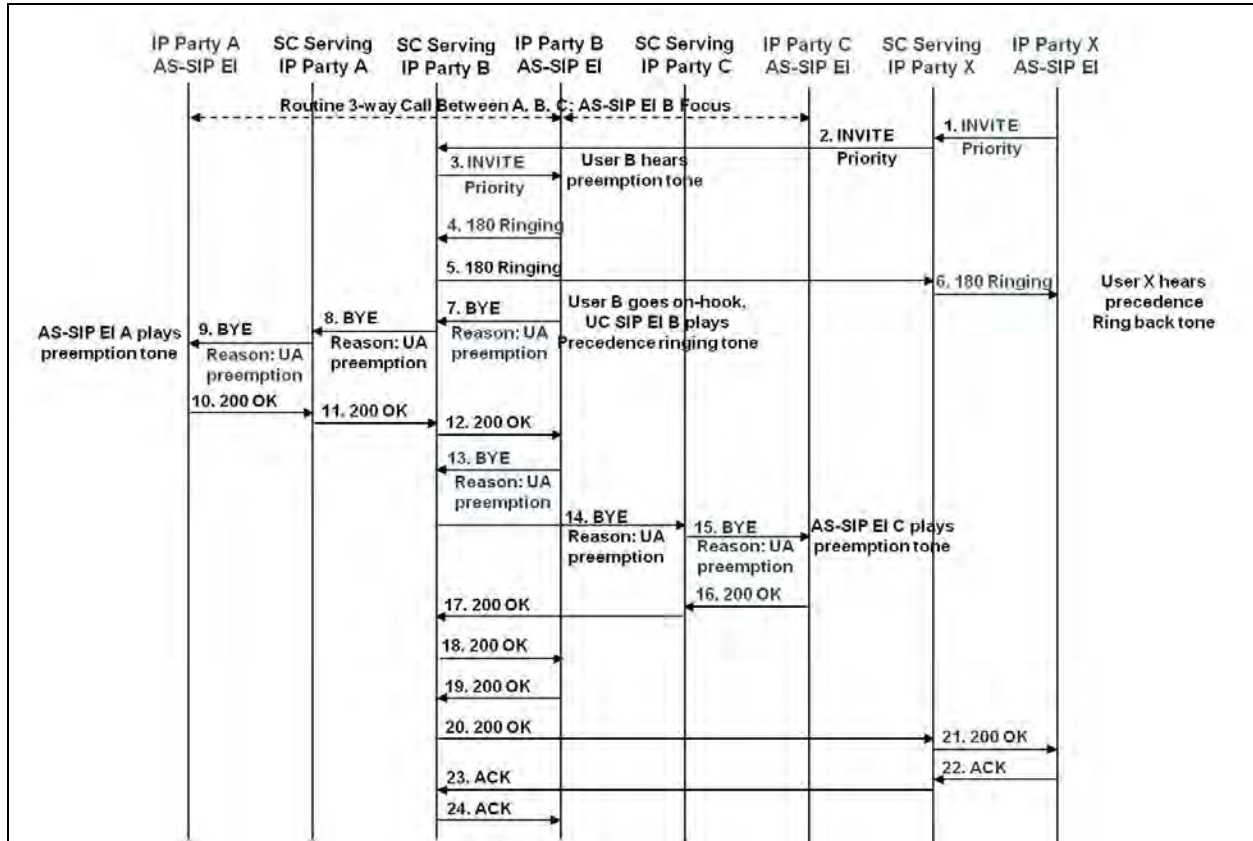

Figure 9.7-1. Endpoint Preemption of Three-Way Call

Referring to [Figure 9.7-1](#), the call flow proceeds as follows:

STEP	INSTRUCTION
1–3	AS-SIP EI X generates a ‘priority’ INVITE that it sends to AS-SIP EI B. Assuming AS-SIP EI B has no idle appearances then AS-SIP EI B must conduct an endpoint preemption of the existing three-way call to accept the ‘priority’ call. AS-SIP EI B plays the preemption tone to user B.
4–6	AS-SIP EI B responds to INVITE by sending 180 ringing to AS-SIP EI B. AS-SIP EI B plays precedence ringback tone to user X.
7–9	AS-SIP EI B sends a BYE to AS-SIP EI A. The BYE includes a Reason Header for Preemption whose cause is 1, “UA Preemption.” Upon receipt of the BYE, AS-SIP EI A plays the preemption tone to user A for up to 3 seconds.
10–12	AS-SIP EI A responds to the BYE by sending 200 OK.
	NOTE: At some point user B goes on-hook and AS-SIP EI B plays the precedence ringing tone.
13–15	AS-SIP EI B sends a BYE to AS-SIP EI C. The BYE includes a Reason Header for Preemption whose cause is 1, “UA Preemption.” Upon receipt of the BYE, AS-SIP EI C plays the preemption tone to user C for up to 3 seconds.
16–18	AS-SIP EI C responds to the BYE by sending 200 OK.
19–21	User B goes on-hook and AS-SIP EI B sends a 200 OK to AS-SIP EI X. AS-SIP EI X ceases playing precedence ringback.
22–24	AS-SIP EI X sends ACK to AS-SIP EI B. The new call between AS-SIP EI X and AS-SIP EI B is

STEP	INSTRUCTION
	now completely established.

SIP-006370 Whenever the focus for a three-way call is at an SC or conference server (instead of at an EI) then even when the originator of the three-way call terminates participation in the call, the other 2 participants are NOT required to be disconnected from the call.

9.7.1.2 Proprietary IP EI (i.e., non-AS-SIP EI) Provides Focus for Three-Way Audio Call

[Figure 9.7-2](#), Proprietary EI provides Focus for Three-Way Call, presents the call flow for a three-way audio call in which a proprietary EI B provides the mixer function for a call between proprietary EI A and proprietary EI B and a call between proprietary EI B and proprietary EI C.

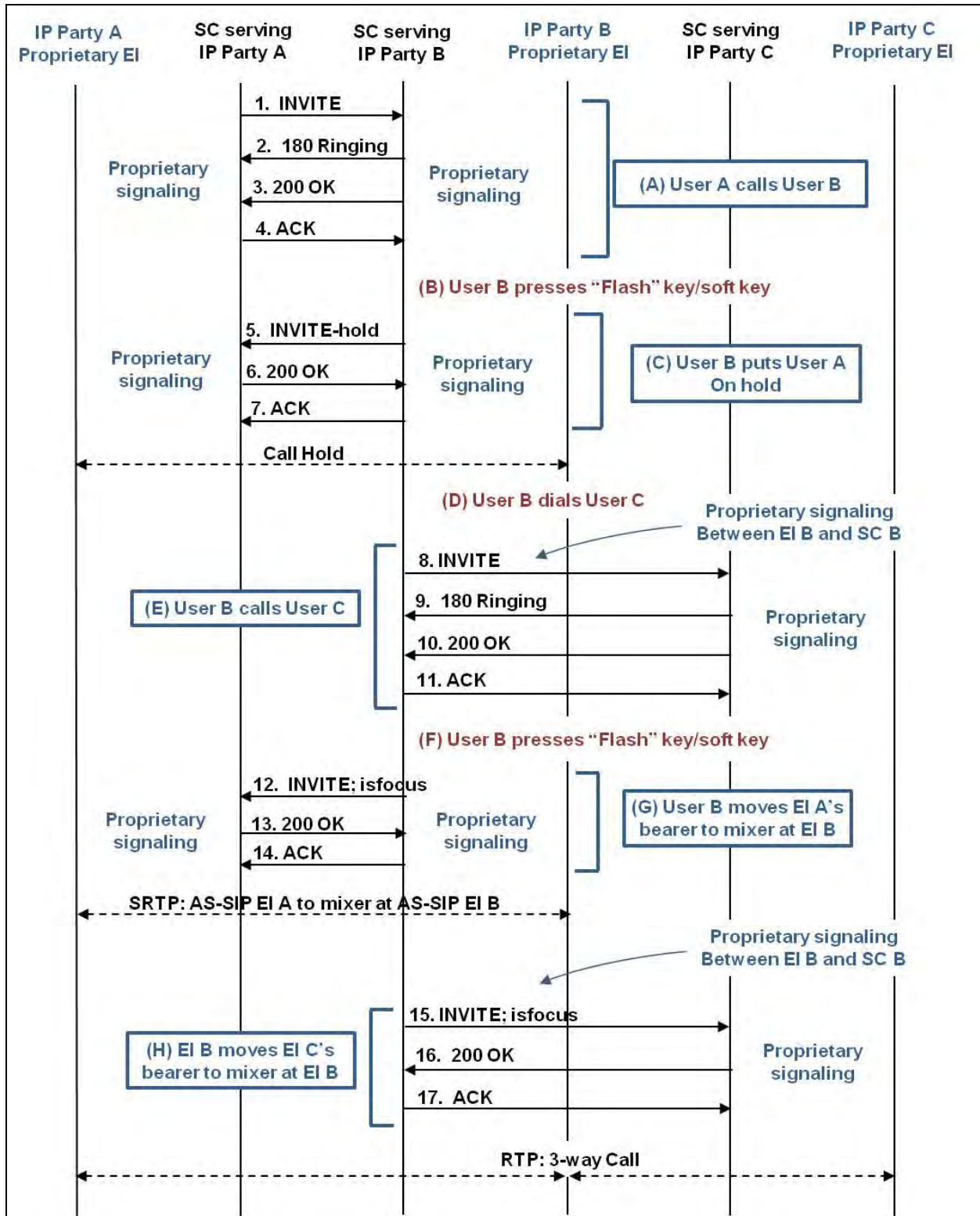

Figure 9.7-2. Proprietary EI Provides Focus for Three-Way Call

The call sequence proceeds as follows:

ACTIVITY REF	STEP	INSTRUCTION
A	1–4	User A calls User B: The SC serving IP party A conducts AS-SIP call set-up with the SC serving IP party B.
		NOTE: The proprietary signaling between EI A and the SC serving EI A and the proprietary signaling between EI B and the SC serving EI B is not depicted in the figure.
B	User Action	User B presses the “Flash” key – this will trigger call hold with EI A and enable User B to dial User C.
C	5–7	SC serving IP party B conducts call hold with SC serving IP party A.
D	User Action	User B enters User C’s phone number or makes a selection to call User C (the user interface can vary).
E	8–11	User B calls User C: The SC serving IP party B conducts AS-SIP call setup with the SC serving IP party C.
F	User Action	User B presses the “Flash” key: This will trigger EI B to move the bearer with EI A to the mixer function at EI B and to move the bearer with EI C to the mixer function at EI B.
G	12–14	The SC serving EI B uses a re-INVITE with the SC serving EI A to move the SRTP bearer to EI B’s mixer.
		NOTE: If the SC supports generation of the ‘isfocus’ feature parameter then the SC adds the “isfocus” feature parameter to the Contact header of the re-INVITE to indicate the call leg is being placed into a conference.
H	15–17	The SC serving EI B uses a re-INVITE with the SC serving EI C to move the SRTP bearer to EI B’s mixer.
		NOTE: If the SC supports generation of the ‘isfocus’ feature parameter then the SC adds the “isfocus” feature parameter to the Contact header of the re-INVITE to indicate the call leg is being placed into a conference.
Result:		The three-way call is now established at proprietary EI B.

9.7.1.3 AS-SIP EI Provides Focus for Three-Way Audio Call

[Figure 9.7-3](#), AS-SIP EI provides Focus for Three-Way Call, presents the call flow for a three-way audio call in which AS-SIP EI B provides the mixer function for a call between AS-SIP EI A and AS-SIP EI B and a call between AS-SIP EI B and AS-SIP EI C.

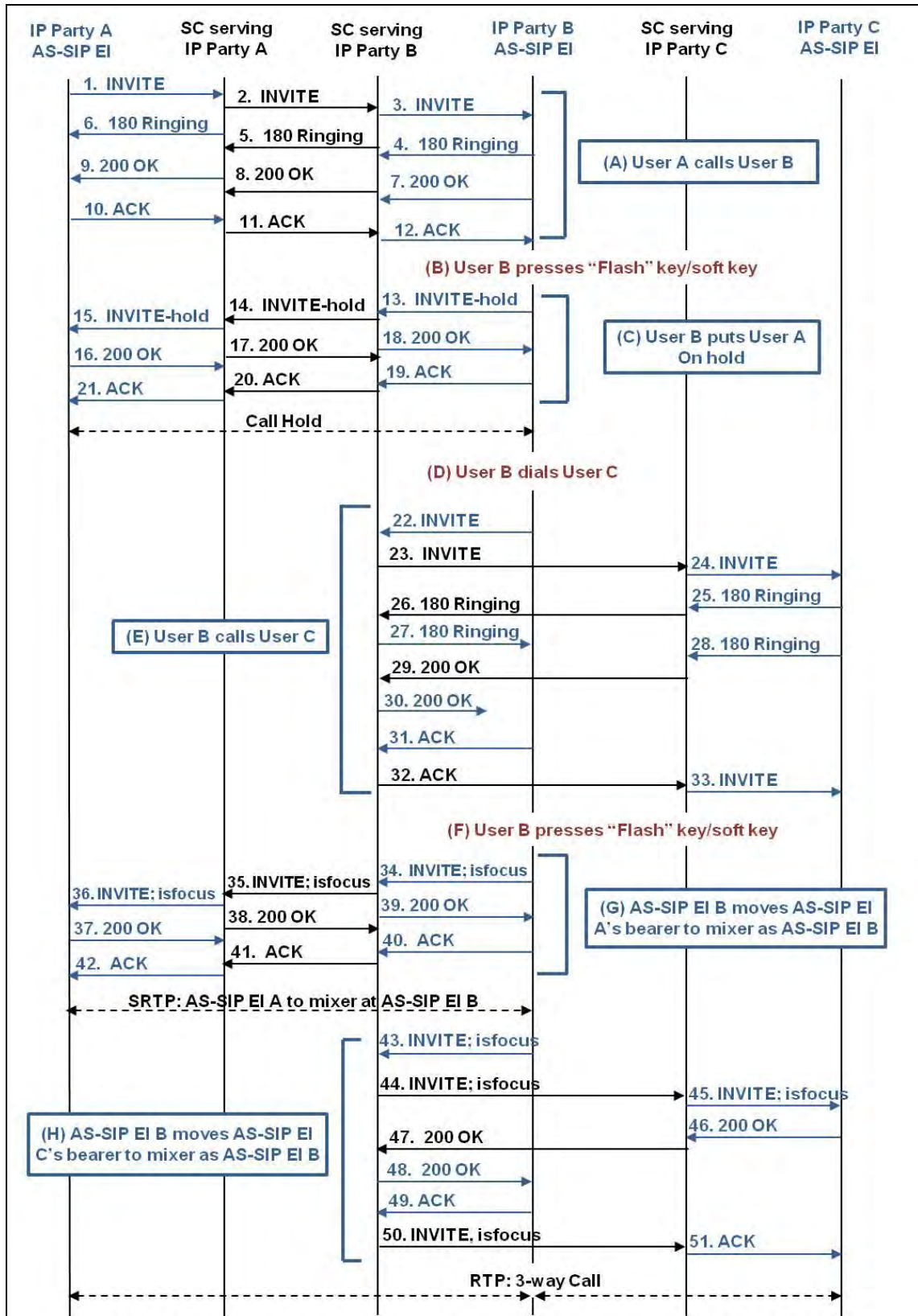

Figure 9.7-3. AS-SIP EI Provides Focus for Three-Way Call

The call sequence proceeds as follows:

ACTIVITY REF	STEP	INSTRUCTION
A	1–12	User A calls User B: AS-SIP EI A conducts call set-up with the AS-SIP EI B.
B	User Action	User B presses the ‘Flash’ key – this will trigger call hold with AS-SIP EI A and enable user B to dial user C.
C	13–21	AS-SIP EI B conducts call hold with AS-SIP EI A.
D	User Action	User B enters User C’s phone number or makes a selection to call User C (the user interface can vary).
E	22–33	User B calls User C: AS-SIP EI B conducts call set-up with AS-SIP EI C.
F	User Action	User B presses the ‘Flash’ key: This will trigger AS-SIP EI B to move the bearer with AS-SIP EI A to the mixer function at AS-SIP EI B and to move the bearer with AS-SIP EI C to the mixer function at AS-SIP EI B.
G	34–42	AS-SIP EI B uses a re-INVITE with AS-SIP EI A to move the SRTP bearer to AS-SIP EI B’s mixer.
		NOTE: If AS-SIP EI B supports generation of the ‘isfocus’ feature parameter then the AS-SIP EI B adds the ‘isfocus’ feature parameter to the Contact header of the re-INVITE to indicate the call leg is being placed into a conference.
H	43–51	The SC serving EI B uses a re-INVITE with the SC serving EI C to move the SRTP bearer to EI B’s mixer.
		NOTE: If AS-SIP EI B supports generation of the ‘isfocus’ feature parameter then the AS-SIP EI B adds the ‘isfocus’ feature parameter to the Contact header of the re-INVITE to indicate the call leg is being placed into a conference.
Result:		The three-way call is now established at AS-SIP EI B.

9.7.2 Three-Way Audio Call Performed by SC on Behalf of Served Proprietary EI w/i SC SUT

Current SC implementations provide three-way calling for served proprietary EIs. This section details the requirements for two alternative SC-based three-way audio call scenarios:

1. The SC serving the user at a proprietary EI that requests the three-way call uses the REFER method to establish the three-way call.
2. The SC serving the user at a proprietary EI that requests the three-way call uses re-INVITE and UPDATE requests to establish the three-way call.

NOTE: The use of the SC-based methods for implementing the three-way audio calling service is limited to the case in which the three-way call request is made by a proprietary EI served by the SC. An SC is NOT required to offer either of the SC-based three-way audio calling services described in [Section 9.7.2.2](#) or [9.7.2.3](#).

9.7.2.1 Precedence and Preemption Rule for Three-Way Audio Calls at SC

SIP-006380 When the call legs in a three-way call have different priority levels the SC takes no action to adjust the priority level of the lower priority call leg to match the precedence of the higher priority call leg.

9.7.2.2 Refer Method for Three-Way Call at SC

ASAC

During the REFER Method, a three-way call is set up:

- SC serving EI A has a maximum of two call counts.
- SC serving EI B has a maximum of three call counts.
- SC serving EI C has a maximum of two call counts.

Upon completion of the establishment of the three-way call:

- SC serving EI A has one call count.
- SC serving EI B has two call counts.
- SC serving EI C has one call count.

Call Flow

[Figure 9.7-4](#), Three-Way Call at SC (REFER Method), depicts the call sequence for an SC employing the REFER method to conduct a three-way call on behalf of a served proprietary EI. (To enhance clarity and save space, the SSs serving the SCs have not been included in [Figure 9.7-5](#).)

NOTE: IP Party A establishes the first call with IP Party B; the user at IP Party B initiates the three-way call and initiates the second call with IP Party C; IP Party C is the third party in the three-way call.

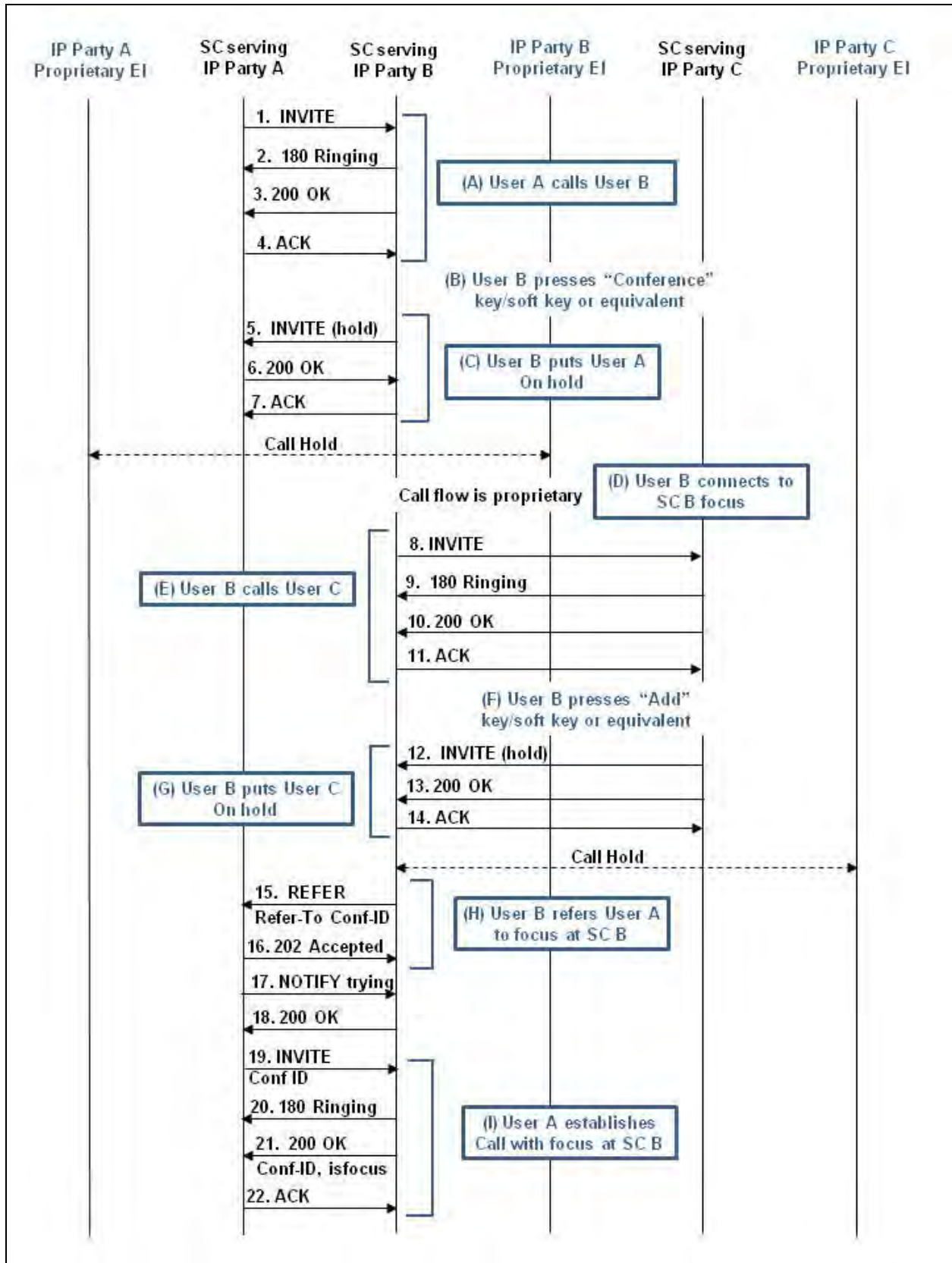

Figure 9.7-4. Three-Way Call at SC (REFER Method) (Steps 1–22)

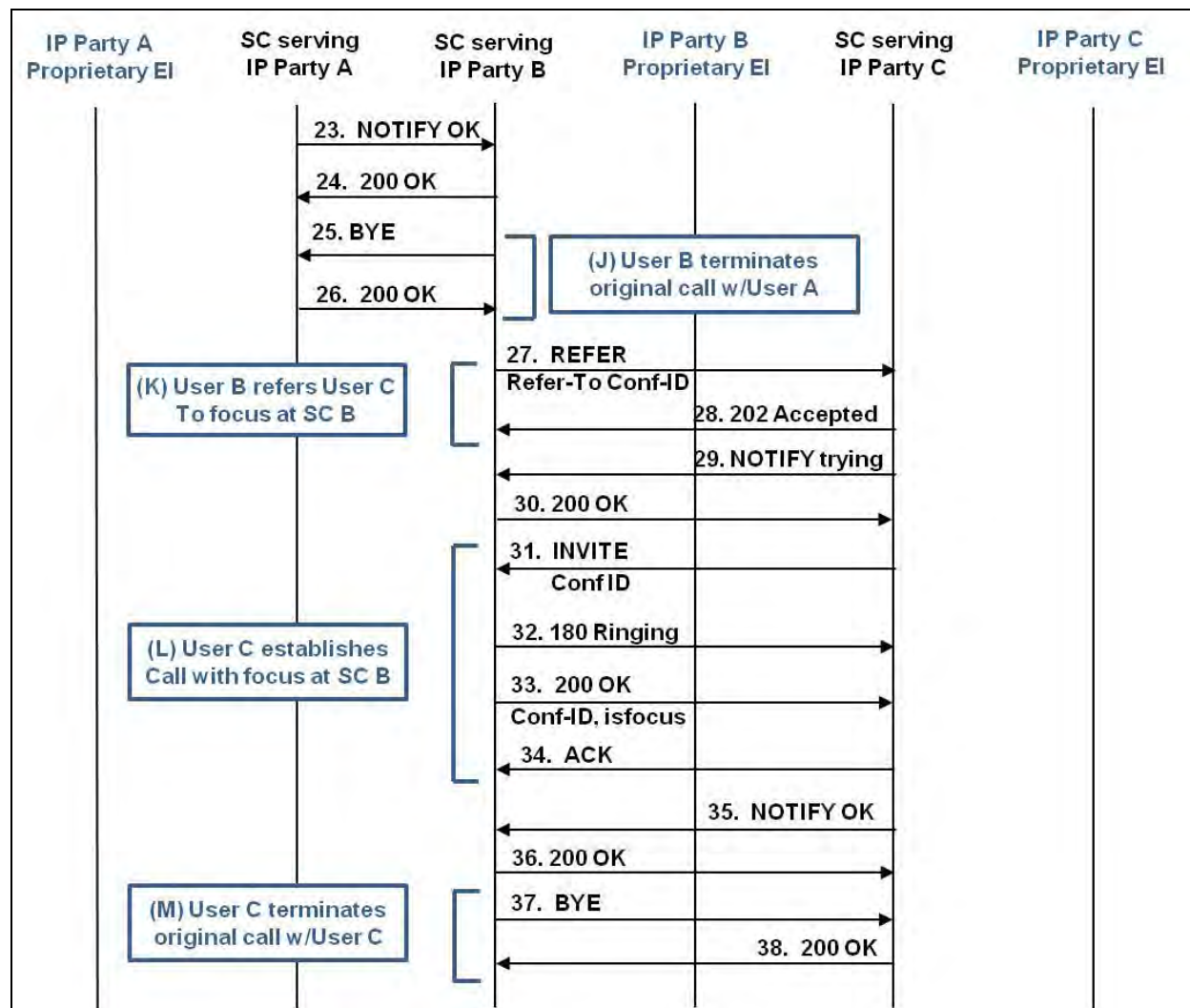

Figure 9.7-5. Three-Way Call at SC (REFER Method) (Steps 23–38)

The call flow sequence for the three-way call using the REFER method is as follows:

ACTIVITY REF	STEP	INSTRUCTION
A	1–4	The SC serving IP Party A establishes a call with the SC serving IP Party B.
B	User Action	The user at IP Party B presses the Conference button/soft key (or equivalent), receives dial tone, and dials User C’s phone number.
C	5–7	The SC serving IP Party B conducts a call hold with the SC serving IP Party A.
D	User Action	IP Party B initiates a session with a focus at the SC serving IP Party B. The SC generates a globally routable Conference URI (also known as Conf-ID) for the new session.
		NOTE: Since User B is using a proprietary EI, the signaling between EI B and the SC serving EI B is vendor dependent and not depicted.
E	8–11	The SC serving IP Party B establishes a call with the SC serving IP Party C.
F	User Action	User C agrees to enter into a three-way call and User at IP Party B presses the Add button/soft key (or equivalent).

ACTIVITY REF	STEP	INSTRUCTION
G	12–14	The SC serving IP Party B conducts a call hold with the SC serving IP Party C.
H	15–18	The SC serving IP Party B generates a REFER request that it sends to the SC serving IP Party A. The SC serving IP Party A responds with 202 (Accepted) response, and then sends a NOTIFY request with the body SIP/2.0 100 trying to which the SC serving IP Party B responds with 200 (OK) response.
		NOTE: The SIP URI of the Refer-to header in the REFER request is the Conf-ID generated by the conference server in Activity Reference D.
II	19–22	The SC serving IP Party A joins the conference session. The Request-URI of the INVITE request sent by the SC serving IP Party A is the globally routable Conf-ID and the SC serving IP Party B MUST include the Conf-ID in the Contact header of the 200 response. If the SC serving IP party B supports the “isfocus” feature tag then the SC serving IP party B adds the “isfocus” feature tag to the Contact header of the 200 response
	23–24	The SC serving IP Party A sends a NOTIFY request with the body SIP/2.0 200 OK to the SC serving IP Party B and receives a 200 (OK) response.
J	25–26	The SC serving IP Party B terminates the call with the SC serving IP Party A.
K	27–30	The SC serving IP Party B generates a REFER request that it sends to the SC serving IP Party C. The SC serving IP Party C responds with 202 (Accepted) response, and then sends a NOTIFY request with the body SIP/2.0 100 trying to which the SC serving IP Party B responds with a 200 (OK) response.
		NOTE: The SIP URI of the Refer-to header of the REFER request is the Conf-ID generated by the conference server in Activity Reference D.
L	31–34	The SC serving IP Party C joins the conference session. The Request-URI of the INVITE request sent by the SC serving IP Party C is the globally routable Conf-ID, and the SC serving IP Party B MUST include the Conf-ID in the Contact header of the 200 response. If the SC serving IP party B supports the “isfocus” feature tag then the SC serving IP party B adds the “isfocus” feature tag to the Contact header of the 200 response.
	35–36	The SC serving IP Party A sends a NOTIFY request with the body SIP/2.0 200 OK to the SC serving IP Party B and receives a 200 (OK) response.
M	37–38	The SC serving IP Party B terminates call with the SC serving IP Party C.

9.7.2.3 Re-INVITE Method for Three-Way Call at SC

ASAC

During the re-INVITE method, a three-way call is set up:

- SC serving EI A has a maximum of one call count.
- SC serving EI B has a maximum of two call counts.
- SC serving EI C has a maximum of one call count.

Upon completion of the establishment of the three-way call:

- SC serving EI A has one call count.
- SC serving EI B has two call counts.

- SC serving EI C has one call count.

Call Flow

[Figure 9.7-6](#), Three-Way Call at SC (Re-INVITE Method), depicts the call sequence for an SC employing the re-INVITE method to conduct a three-way call on behalf of a served proprietary EI. (To save space and to enhance clarity, the SSs serving the SCs have not been included in [Figure 10.2-1](#).)

NOTE: IP Party A establishes the first call with IP Party B; the user at IP Party B initiates the three-way call and initiates the second call with IP Party C; IP Party C is the third party in the three-way call.

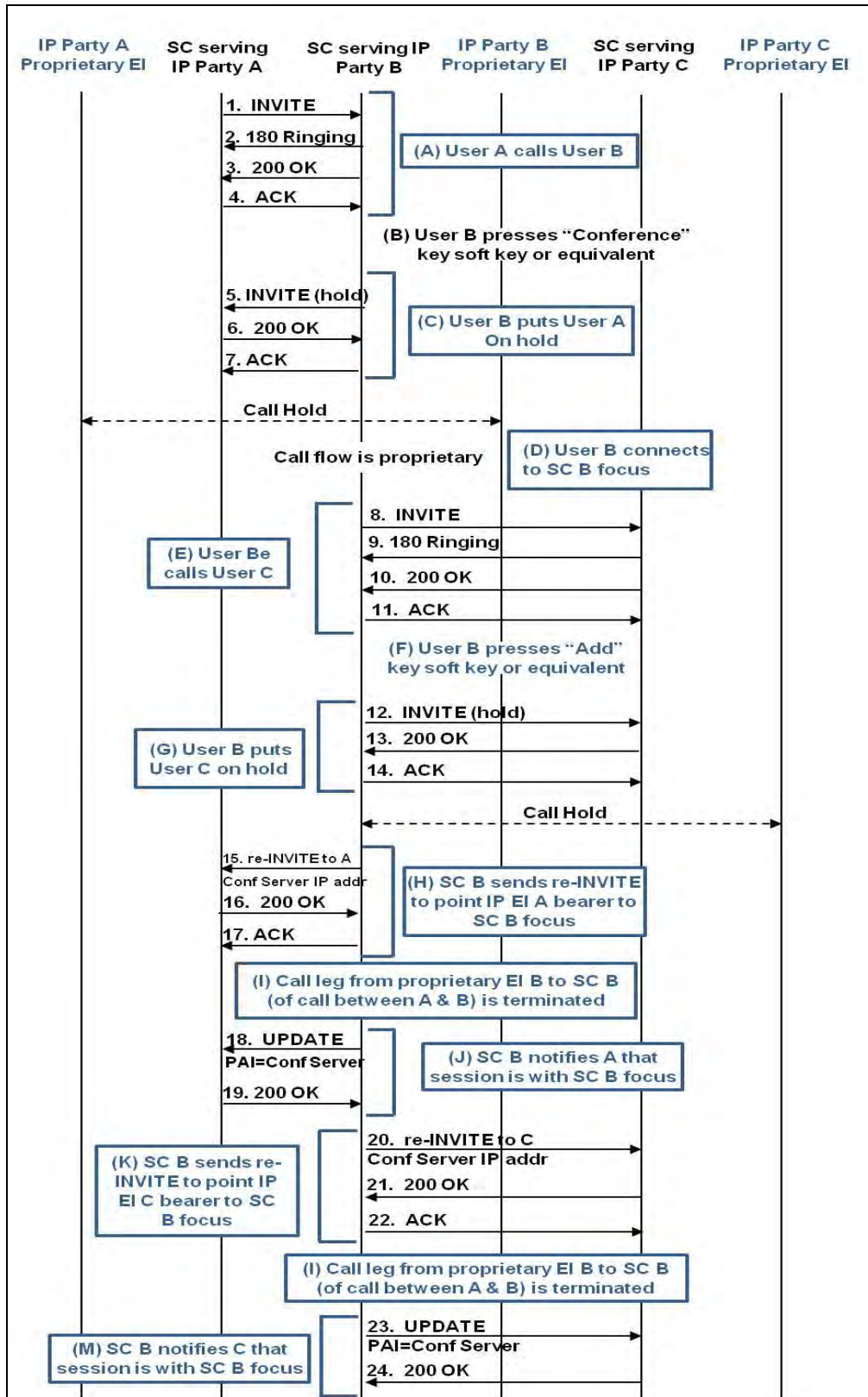

Figure 9.7-6. Three-Way Call at SC (RE-INVITE Method)

The call flow sequence for the three-way call using the re-INVITE method is as follows:

STEP	INSTRUCTION
1–4	The SC serving IP Party A establishes a call with SC serving IP Party B (steps 1–4).
	User at IP Party B presses Conference button/soft key (or equivalent), receives dial tone, and dials User C’s phone number.
5–7	The SC serving IP Party B conducts call hold with SC serving IP Party A (steps 5–7).
	IP Party B initiates session with a focus at SC serving IP Party B. The SC generates a globally routable Conference URI (also known as a Conf-ID) for the new session.
	NOTE: Since User B is using a proprietary EI, the signaling between EI B and the SC serving EI B is vendor dependent and not depicted.
8–11	The SC serving IP Party B establishes a call with the SC serving IP Party C (steps 8–11).
	User C agrees to enter into a three-way call and user at IP Party B presses the Add button or soft key (or equivalent).
12–14	The SC serving IP Party B conducts a call hold with the SC serving IP Party C (steps 12–14).
15–17	The SC serving IP Party B sends a re-INVITE request to the SC serving IP Party A. The re-INVITE transaction enables the SC serving IP Party B to point the IP Party A bearer to the focus and enables the SC serving IP party B to renegotiate the media stream with the SC serving IP Party A. The SC serving IP Party B places the Conf-ID (from Step D) and the feature tag “isfocus” in the Contact header of the INVITE request. If the SC serving IP party B supports the “isfocus” feature tag then the SC serving IP party B adds the “isfocus” feature tag to the Contact header of the INVITE request (steps 15–17).
	The SC serving IP Party B signals IP Party B that the call between IP Party A and IP Party B is being terminated. The call termination is conducted using proprietary signaling between the SC serving IP Party B and IP Party B.
18–19	The SC serving IP Party B sends an UPDATE request to the SC serving IP Party A having a P-Asserted-Identity header in which the name-addr field identifies the SC B focus and the SIP URI is the conference-ID for the session generated in Step D (steps 18 and 19).
20–22	The SC serving IP Party B sends a re-INVITE request to the SC serving IP Party C. The re-INVITE transaction enables the SC serving IP Party B to point the IP Party C bearer to the focus and enables the SC serving IP party B to renegotiate the media stream with the SC serving IP Party C. The SC serving IP Party B places the Conf-ID (from Step D) in the Contact header of the INVITE request. If the SC serving IP party B supports the “isfocus” feature tag then the SC serving IP party B adds the “isfocus” feature tag to the Contact header of the INVITE request (steps 20–22).
	The SC serving IP Party B signals IP Party B that the call between IP Party C and IP Party B is being terminated. The call termination is conducted using proprietary signaling between the SC serving IP Party B and IP Party B.
23–24	The SC serving IP Party B sends an UPDATE request to the SC serving IP Party C having a P-Asserted-Identity header in which the name-addr field identifies the SC B focus and the SIP URI is the Conf-ID for the session generated in Step D (steps 23 and 24).

SECTION 10 AUDIO AND VIDEO CONFERENCE SERVICES

10.1 AUDIO CONFERENCE SERVERS AND VIDEO CONFERENCE SERVERS

A conference server can be implemented as one of the following:

- An audio conference server only (otherwise known as an audio conference bridge).
- A video conference server only (otherwise known as a Multipoint Control Unit [MCU]).
- An audio-video conference server (capable of simultaneously supporting both audio conference sessions and video conference sessions).

10.1.1 SC (or SS)-Conference Server Configurations

SIP-006390 There are 2 valid ‘SC (or SS) – conference server’ configurations:

1. A conference server that is a component of a SC (or SS) system under test. The interface between the conference server and the SC (or SS) is proprietary and not subject to specification by the UCR.
2. An AS-SIP conference server that is a stand-alone component constituting its own system under test. The AS-SIP conference server **MUST** have an AS-SIP interface and **MUST** connect to a SC (or SS) over the AS-SIP interface.

Vendors may implement either configuration.

NOTE: The conference server call flows in this section are designed to support architectural flexibility in the placement of conference server resources. The default conference server for an EI may be at the SC directly serving the EI or at another SC within the enclave or at a SC or SS that is at a remote location from the EI.

SIP-006400 [Optional] It is an optional requirement for a conference server that is a component of a SC (or SS) to support the RFC 4575 conference event package.

SIP-006410 [Optional] It is an optional requirement for a stand-alone AS-SIP conference server to support the RFC 4575 conference event package.

SIP-006420 [Optional] It is an optional requirement for a conference server that is a component of a SC (or SS) to include the “isfocus” feature parameter in the Contact header field for purposes of indicating that the AS-SIP dialog belongs to a conference.

SIP-006430 [Optional] It is an optional requirement for a stand-alone AS-SIP conference server to include the “isfocus” feature parameter in the Contact header field for purposes of indicating that the AS-SIP dialog belongs to a conference.

SIP-006440 In order to initiate an Ad Hoc Conference an AS-SIP EI MUST be configured with the globally routable Conference-Factory URI for its designated audio conference server.

SIP-006450 When the designated audio conference server for proprietary EIs served by an SC is either located at a remote SC or SS or is an AS-SIP conference server then in order to support initiation of Ad Hoc conferences by served EIs the SC MUST be provisioned with the globally routable Conference-Factory URI of the audio conference server.

10.1.2 Precedence and Preemption Rules for Audio and Video Conference Servers

SIP-006460 When the call legs in an ad hoc conference session have different priority levels the conference server is NOT required to elevate the conference precedence level to the highest precedence level of the dialed conferees.⁸⁸

SIP-006470 The conference server is NOT required to conduct preemption. When a conference server that does NOT support preemption receives a call request to join a session that is currently at its maximum allotment of session participants, the AS-SIP conference server SHALL respond with a 480 (Temporarily Unavailable). When a conference server that does NOT support preemption and is currently at its maximum number of concurrent sessions, receives a call request to initiate a new session then the conference server SHALL respond with a 480 (Temporarily Unavailable).⁸⁹

10.1.3 Definitions of Terms

Conference Factory URI: A published URI associated with a conference server to which users send call requests in order to automatically create ad-hoc conferences. In the DSN the userinfo part of the Conference Factory URI consists of a designated routable 10-digit number assigned to a conference server. The Conference Factory URI is the Request-URI of the INVITEs sent by users to a conference server in order to automatically create ad-hoc conferences. (see RFC 4579, Session Initiation Protocol (SIP) Call Control – Conferencing for User Agents, Section 3.2 and Section 5.4).

Conference URI (used interchangeably in this document with the terms Conference ID or Conf-ID): “A URI, usually a SIP URI, that identifies the focus of a conference.” (from RFC 4353 Conferencing Framework with SIP Section 2). The Conference URI is a unique URI assigned to a conference session that enables the routing of SIP requests to the dedicated conference focus for the conference session. In the DSN the userinfo part of the Conference URI consists of a routable 10-digit number (which is a member of a pool of numbers owned by the conference

⁸⁸ Note: In the case of Meet Me conferences and scheduled conferences the conference precedence level is not elevated to the highest precedence level of the dialed conferees. In Preset conferences the conference host is dialed at the highest precedence level of any conferee.

⁸⁹ If a vendor chooses to develop a conference server with the capability to conduct preemption then the applicable requirements are set forth in DoD UCR 2013, Section 3 subsection 3.4.3.4.2.3 Multilevel Precedence and Preemption.

server) that is assigned to a particular conference. The Conference URI is the Request-URI of the INVITE that a user sends to join a specific conference or the Request-URI of the SUBSCRIBE request that a user sends to subscribe to the conference event package for a specific conference.

10.1.4 EI Requirements Related to Audio Conferencing

SIP-006480 [Optional] It is recommended but NOT required that AS-SIP EIs be conference-aware (i.e., support the SIP Event Package for Conference State [RFC 4575] and support the receipt/processing and generation of the “isfocus” feature tag placed in the Contact header of the request or response per RFC 4579 Session Initiation Protocol [SIP] Call Control - Conferencing for User Agents).

SIP-006490 [Optional] SIP EIs MAY be conference-aware (i.e., support the SIP Event Package for Conference State [RFC 4575] and support the receipt/processing and generation of the “isfocus” feature tag placed in the Contact header of the request or response per RFC 4579 Session Initiation Protocol [SIP] Call Control - Conferencing for User Agents).

SIP-006500 EIs that do not employ SIP or AS-SIP signaling are NOT required to support the SIP Event Package for Conference State (RFC 4575) or the “isfocus” feature tag (RFC 4579). The SC serving EIs that do not employ SIP or AS-SIP signaling is NOT required to support the SIP Event Package for Conference State or the “isfocus” feature tag on their behalf.

10.2 AUDIO CONFERENCING

10.2.1 Ad Hoc Audio Conference

The Ad Hoc Audio Conference is an ‘on demand’ service where the conference initiator creates the conference on the fly by sending a request to a provisioned Conference-Factory URI belonging to the conference server. The conference server creates the conference session and enables the conference initiator (a.k.a. host) to sequentially connect to each prospective participant via the conference server to invite each prospective participant to join the conference session.

The conference is NOT scheduled in advance and the participants may not receive prior notice of the date and time of the conference. In addition, they will not receive a conference-ID or a dial-in number for the conference server or an access code.

Note: For purposes of UCR 2013 an N-way audio call performed at an SC (whereby the call flow is an extension of the three-way call scenarios described in sec 9.7.2) shall be considered a compliant implementation alternative to the Ad Hoc audio conference set forth in this section.

SIP-006510 When implementing an ad hoc audio conference the call flow MUST proceed in accordance with the following event sequence:

1. The host (conference initiator) initiates a call request to the Conference-Factory URI for the conference server by pressing the Conference button (or equivalent) on the conference initiator's EI.

NOTE: Party B is the conference initiator in the ad hoc audio conference call flows.

- a. In the case of an AS-SIP EI, pressing the 'Conference' button or an equivalent key or soft key generates an INVITE in which the Conference-Factory URI is placed in the Request-URI field.
 - b. In the case of a proprietary EI for which either the conference server is not located at the SC directly serving the proprietary EI or the conference server is an AS-SIP conference server then the SC MUST generate (or forward) an INVITE and place the Conference-Factory URI in the Request-URI field.
2. The conference server prompts the caller for the caller's host code over the SRTP audio bearer.
 3. The conference initiator responds by entering the host code and transmitting it over the SRTP audio bearer per RFC 4733 RTP Payload for DTMF Digits, Telephony Tones, and Telephony Signals.
 4. Upon receipt of a valid host code the conference server creates an Ad Hoc session and provides the conference initiator with the Conference ID (Conf-ID) for the session in the contact header of the re-INVITE. If the conference server supports the "isfocus" feature tag then the conference server places the 'isfocus' feature tag in the contact header to identify that the conference server is a focus. The conference initiator's SRTP audio bearer does not yet point to the conference itself but rather the conference initiator will be prompted to add participants to the Ad Hoc conference.
 5. If the conference initiator is at an EI that is conference-aware and the Contact header of the re-INVITE included the "isfocus" feature tag then the conference initiator EI subscribes to the RFC 4575 SIP event package for conference state.

~~NOTE: AS-SIP EIs MUST be conference-aware.~~

6. The conference server prompts the conference initiator over the SRTP audio bearer to enter the phone number of a user that the conference initiator wishes to add to the conference.
7. The conference initiator sends to the conference server the phone number of a user to add to the ad hoc conference. The phone number digits are transmitted as DTMF digits over the audio bearer between the conference initiator and the conference server. The user interface of the EI will vary. For example, the user may input the digits on a keypad or select the user from a dropdown menu, etc.
8. The conference server generates an INVITE with a Request URI based upon the phone number digits received from the conference initiator. The r-priority field in the Resource-Priority header of the INVITE will be set to the same value as the r-priority field of the

INVITE originally sent by the conference initiator to the Conference-Factory URI. The session Conf-ID is placed in the sip URI of the contact header of the INVITE. If the conference server supports the “isfocus” feature tag then the conference server adds the ‘isfocus’ tag to the contact header.

NOTE: This INVITE actually initiates a 2-party call between the EI to which the INVITE is addressed (user X in the call flow diagrams) and the conference initiator.

9. The conference initiator speaks with user X over the SRTP audio bearer and asks user X to join the ad hoc conference. If user X agrees then the conference initiator sends a DTMF sequence over the SRTP audio bearer that signifies to the conference server that the user is to be added to the conference.

It is recognized that different conference servers will support different DTMF sequences for the various operations and the users will need to be apprised of the DTMF command sequences applicable to their default conference server.

It is also recognized that the user interface for selecting and sending the DTMF sequence will vary and may consist of entering symbols and digits on a keypad or pressing a hard key or selecting a soft key, etc.

10. If the user X EI is conference-aware and the Contact header of the INVITE included the “isfocus” feature tag then the user X EI subscribes to the RFC 4575 SIP event package for conference state.
11. Upon receiving a DTMF sequence indicating that user X is to be placed in the conference session, the conference server internally moves the SRTP audio bearer stream with the user X EI to the focus for the conference session. This action is transparent to the user X EI. There is no need for the conference server to send a re-INVITE to the user X EI in order to change the IP address and UDP port for the SRTP audio bearer stream.
12. The conference server prompts the conference initiator over the SRTP audio bearer to enter the phone number of another user that the conference initiator wishes to add to the conference. Essentially, the conference initiator and conference server cycle through steps 6–11 until the conference initiator has added or attempted to add all of the desired participants to the ad hoc conference. The conference initiator then joins the other participants in the ad hoc conference by entering a predefined DTMF sequence instead of another user phone number. For example, the DTMF sequence used to add participants could also be used to signal to the conference server to move the conference initiator’s SRTP audio stream to the conference session when the DTMF sequence is received in the absence of a previously received phone number.

10.2.1.1 Call Flow Diagrams

Four call flow diagrams are presented depicting the establishment of ad hoc audio conferences per the event sequence defined in SIP-006510.1. In each diagram the conference initiator is party

B. Each call flow depicts party B adding user X located at a proprietary IP EI and user Y located at an AS-SIP EI.

[Figures 10.2-1](#) through [10.2-3](#) and [Figures 10.2-4](#) through [10.2-6](#) cover the cases in which the conference server is a component of the SC and EI B is a proprietary EI and an AS-SIP EI, respectively.

[Figures 10.2-7](#) through [10.2-9](#) and [Figures 10.2-10](#) through [10.2-12](#) cover the cases in which the conference server is a stand-alone AS-SIP conference server and EI B is a proprietary EI and an AS-SIP EI, respectively.

10.2.1.1.1 Ad Hoc Conference Scenario 1: Conference Server Within SC SUT – Conference Initiator at Proprietary EI

[Figures 10.2-1](#) through [10.2-3](#), Ad Hoc Conference – Conference Server within SC SUT, Conference Initiator at Proprietary EI, depict the call flow sequence for the ad hoc call scenario in which the conference server is a component of the SC and the conference initiator is using a proprietary EI.

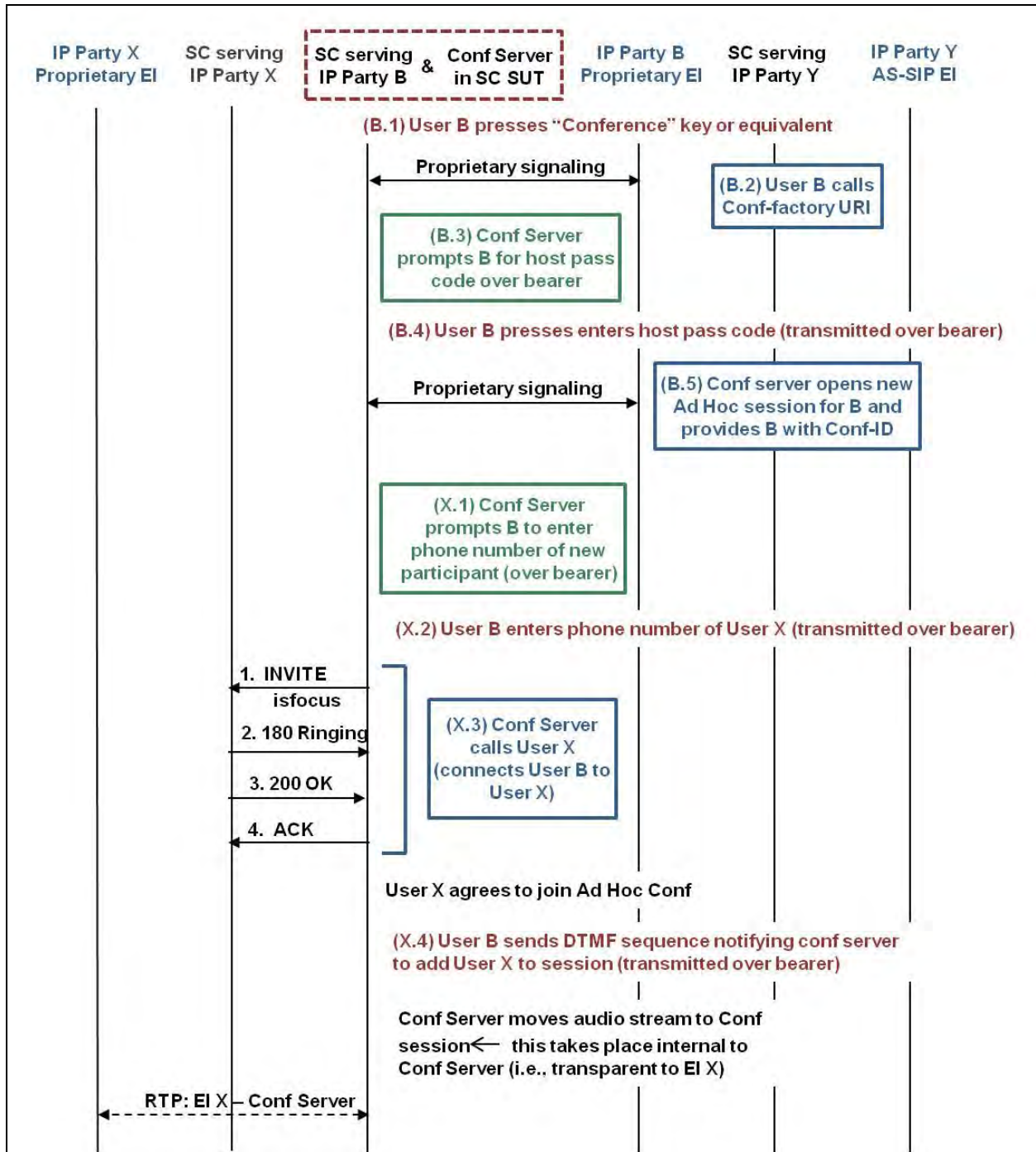

Figure 10.2-1. Ad Hoc Conference – Conference Server Within SC SUT, Conference Initiator at Proprietary EI (Steps 1–4)

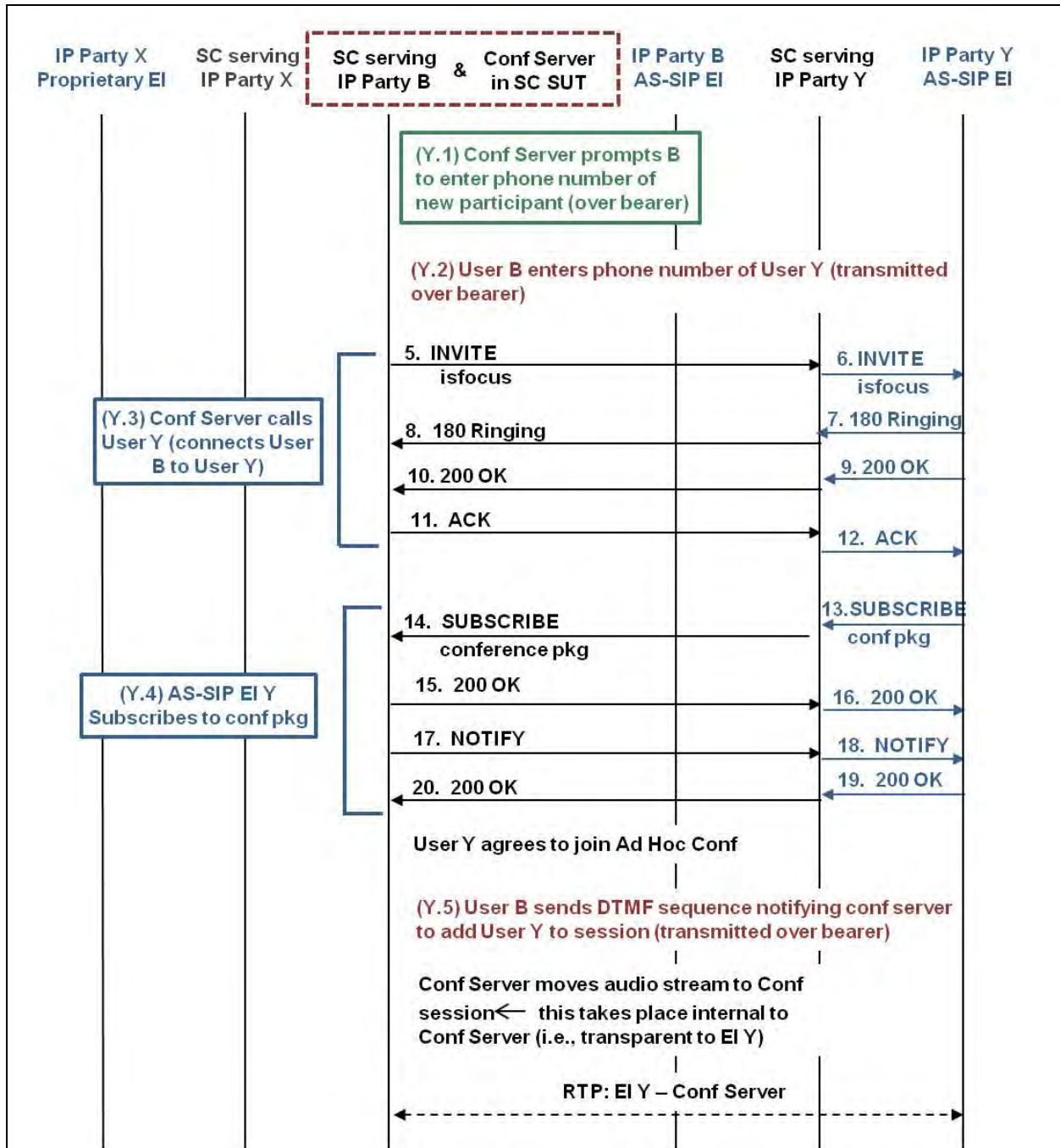

Figure 10.2-2. Ad Hoc Conference – Conference Server Within SC SUT, Conference Initiator at Proprietary EI (Steps 5–20)

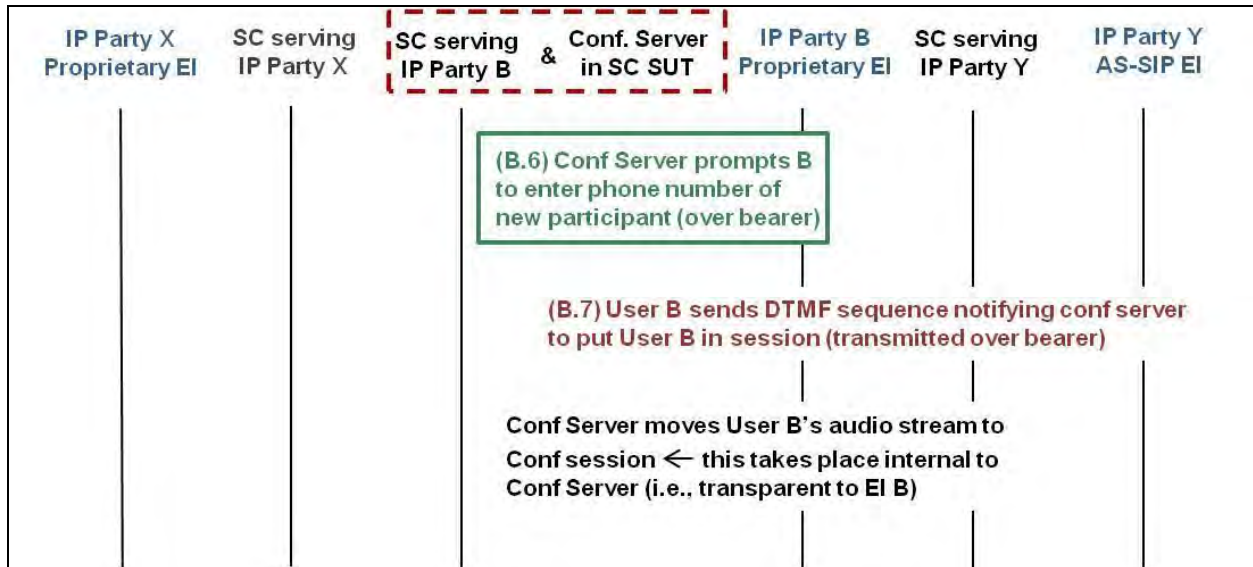

Figure 10.2-3. Ad Hoc Conference – Conference Server Within SC SUT, Conference Initiator at Proprietary EI

10.2.1.1.2 Ad Hoc Conference Scenario 2: Conference Server Within SC SUT – Conference Initiator at AS-SIP EI

[Figures 10.2-4](#) through [10.2-6](#), Ad Hoc Conference – Conference Server within SC SUT, Conference Initiator at AS-SIP EI, depict the call flow sequence for the Ad Hoc call scenario in which the Conference Server is a component of the SC and the conference initiator is using an AS-SIP EI.

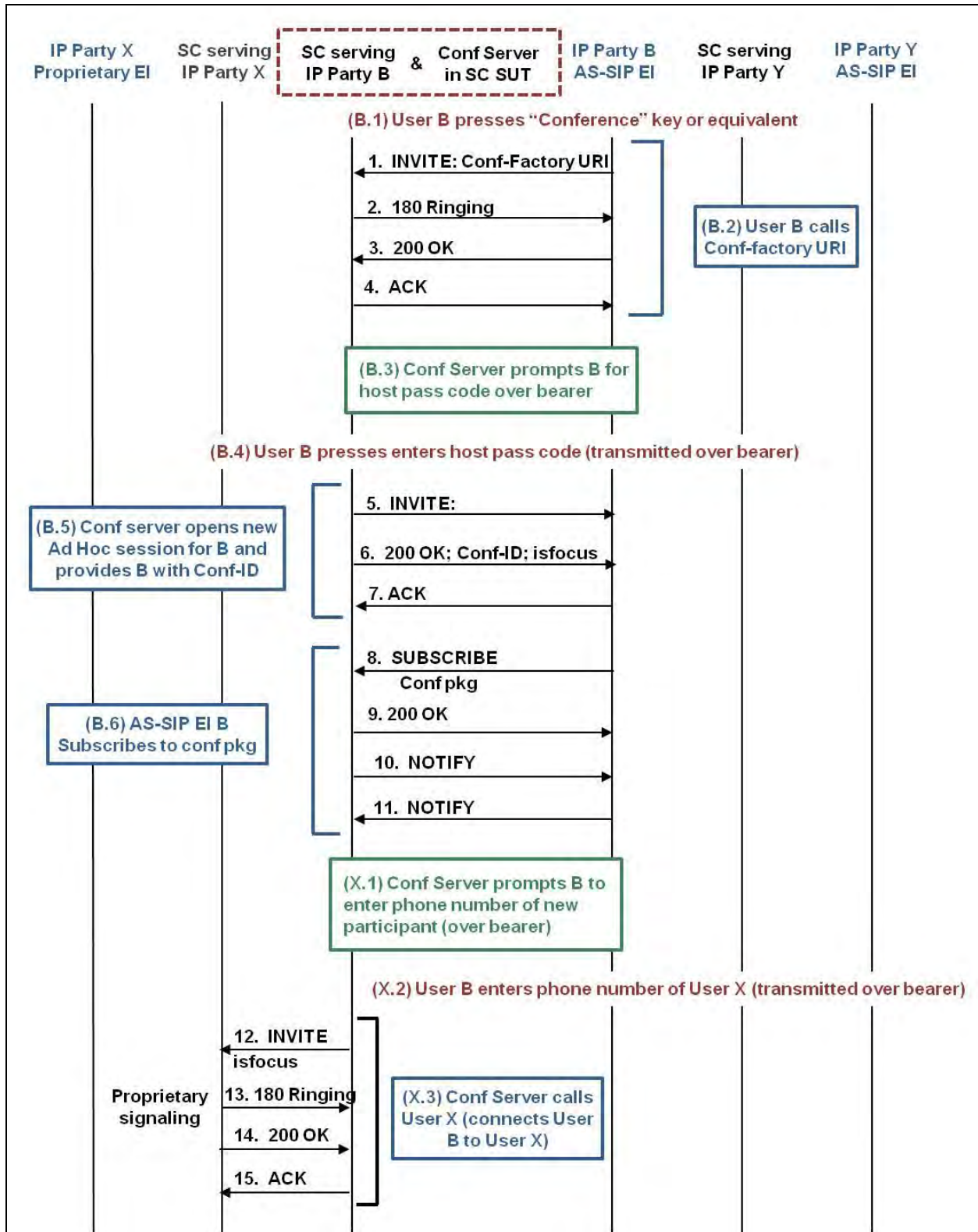

Figure 10.2-4. Ad Hoc Conference – Conference Server Within SC SUT, Conference Initiator at AS-SIP EI (Steps 1–15)

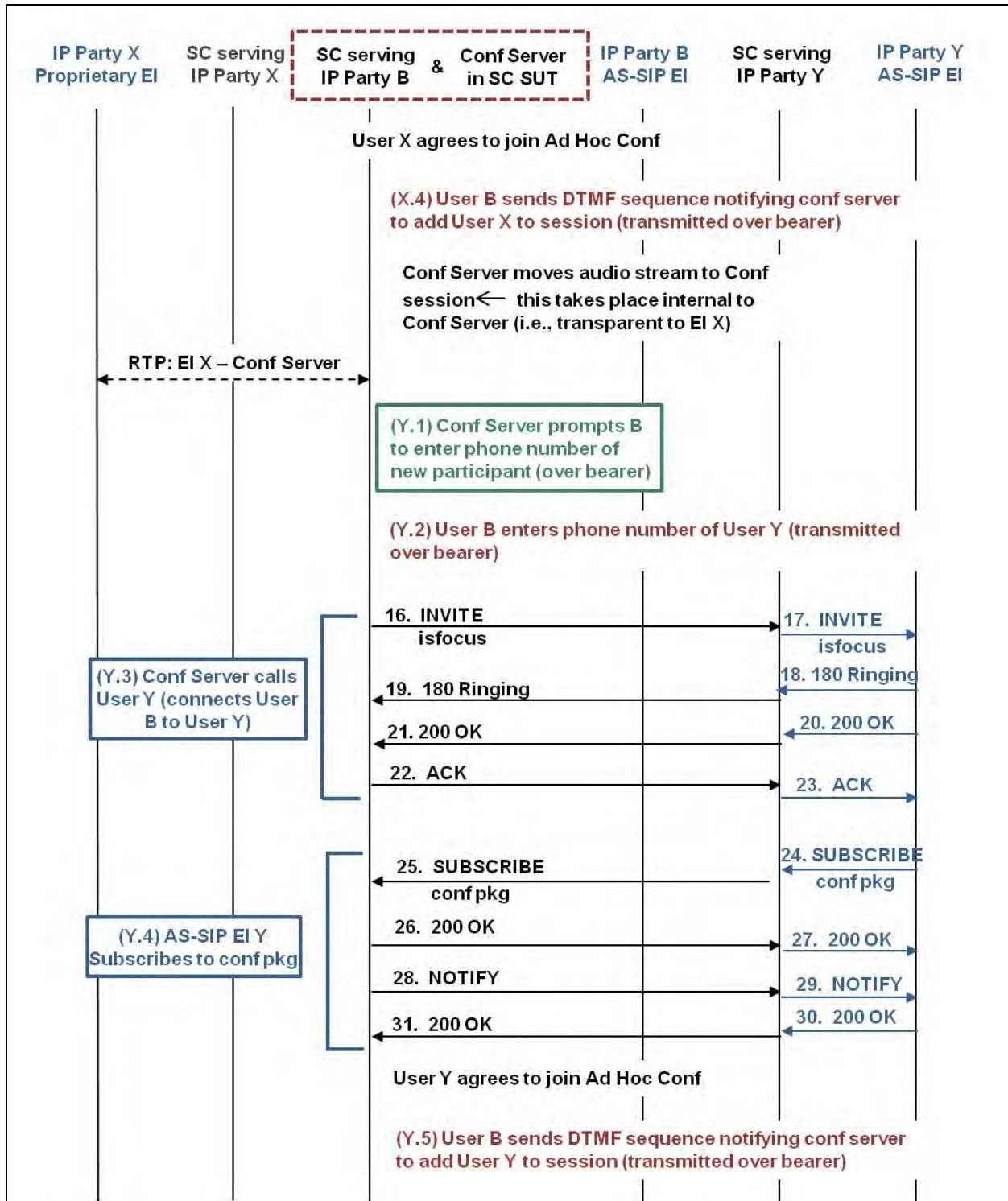

Figure 10.2-5. Ad Hoc Conference – Conference Server Within SC SUT, Conference Initiator at AS-SIP EI (Steps 16–31)

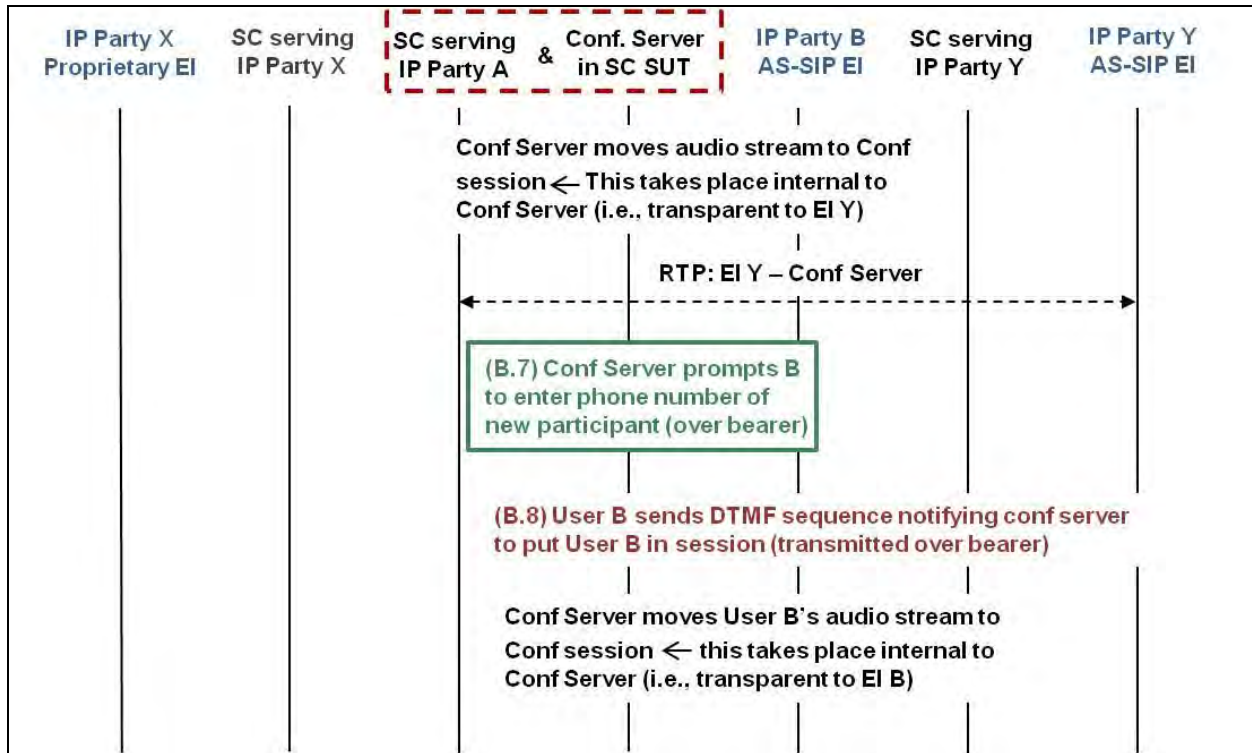

Figure 10.2-6. Ad Hoc Conference – Conference Server Within SC SUT, Conference Initiator at AS-SIP EI

10.2.1.1.3 Ad Hoc Conference Scenario 3: AS-SIP Conference Server (Stand-Alone SUT) – Conference Initiator at Proprietary EI

Figures 10.2-7 through 10.2-9, Ad Hoc Conference – AS-SIP Conference Server, Conference Initiator at Proprietary EI, depict the call flow sequence for the Ad Hoc call scenario in which the Conference Server is a stand-alone AS-SIP conference server and the conference initiator is using a proprietary EI.

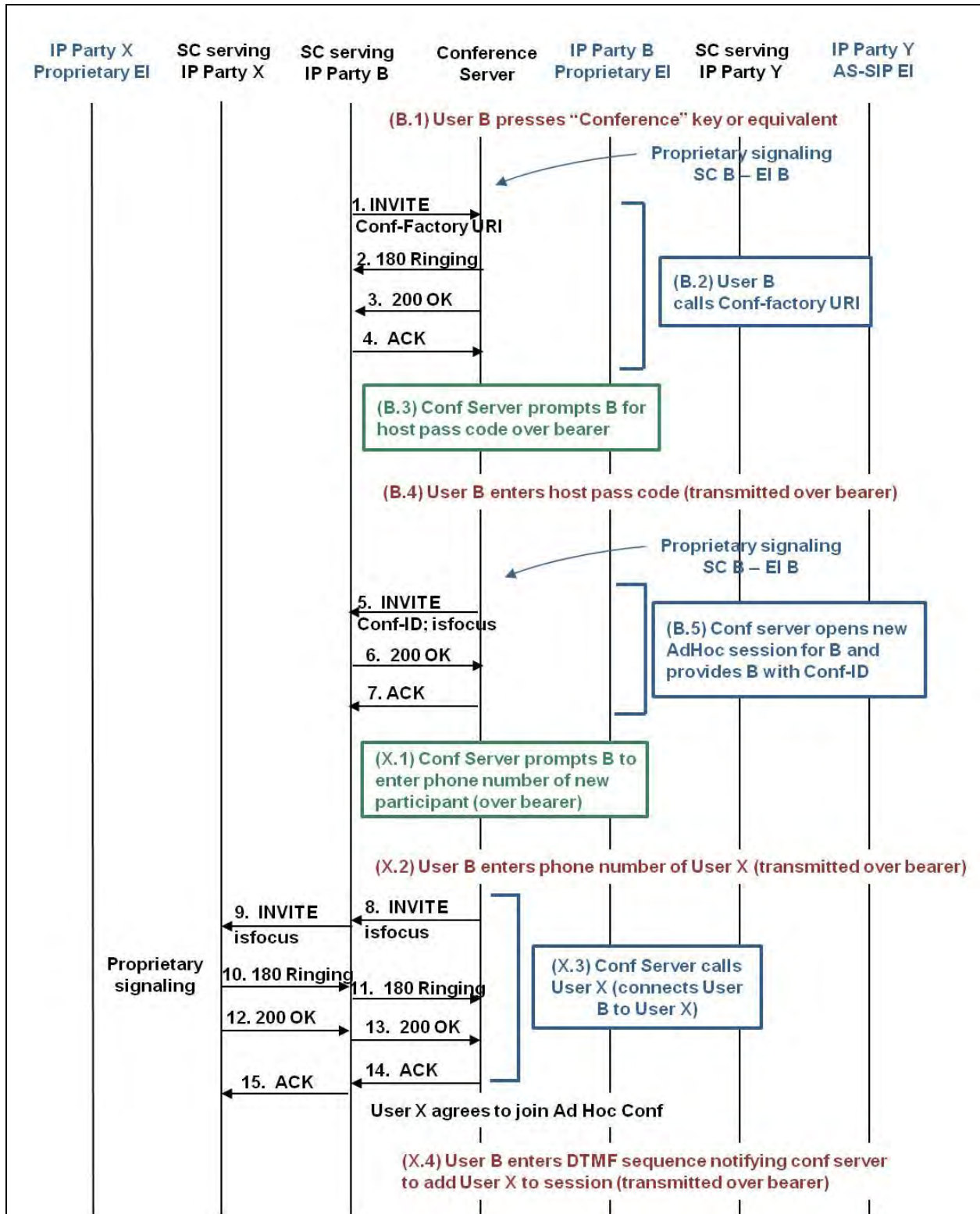

Figure 10.2-7. Ad Hoc Conference – AS-SIP Conference Server, Conference Initiator at Proprietary EI (Steps 1–15)

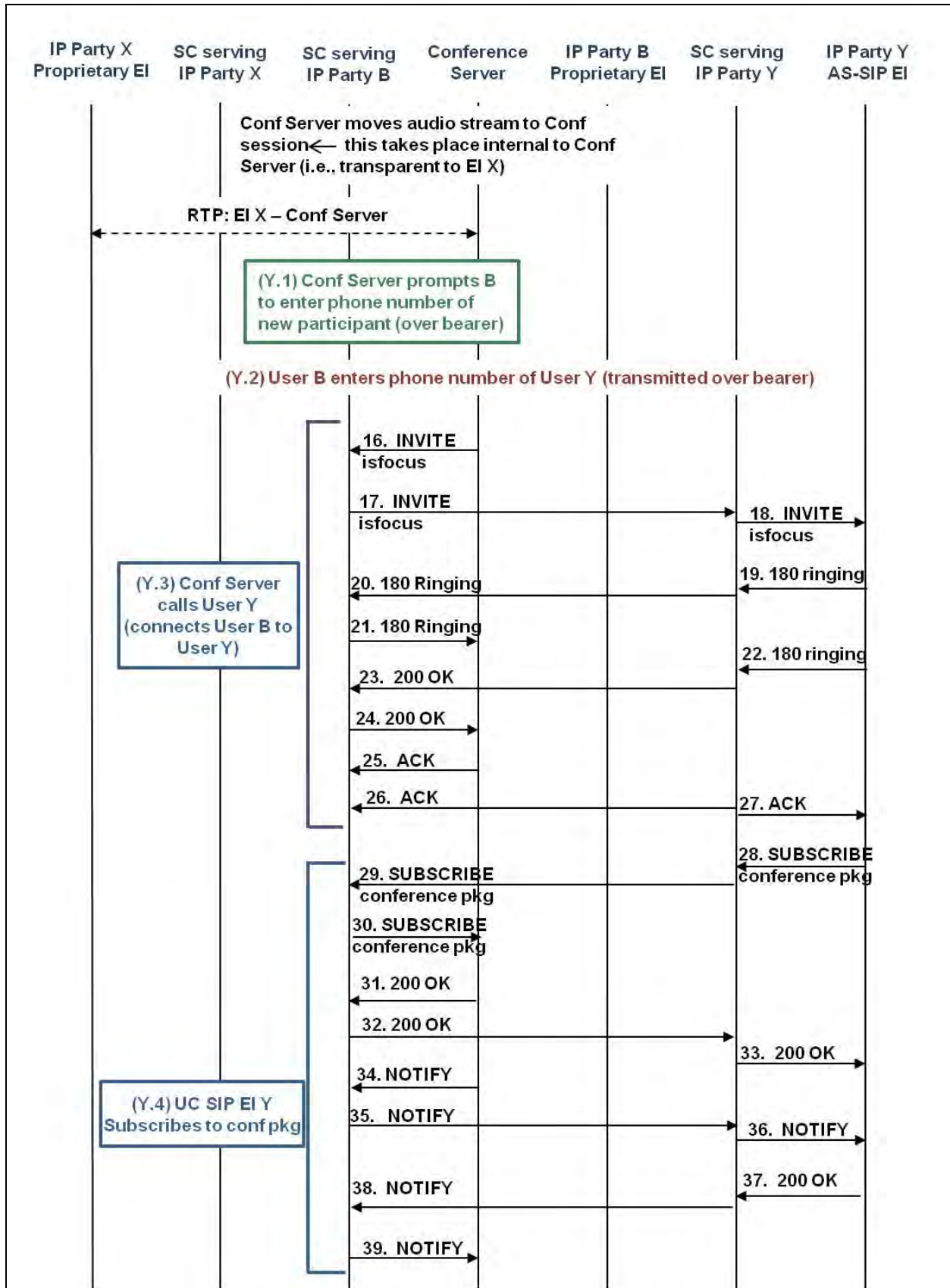

Figure 10.2-8. Ad Hoc Conference – AS-SIP Conference Server, Conference Initiator at Proprietary EI (Steps 16–39)

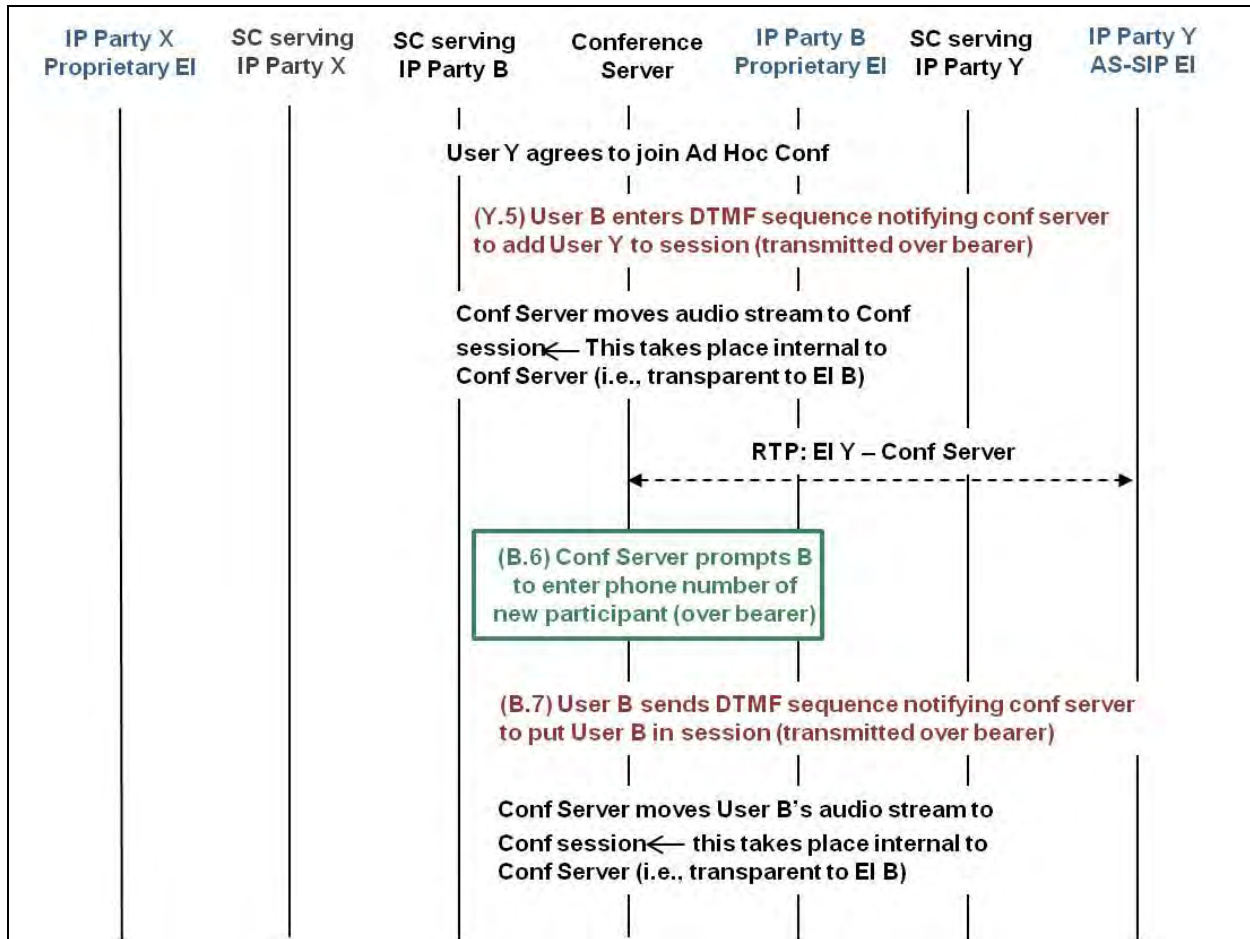

Figure 10.2-9. Ad Hoc Conference – AS-SIP Conference Server, Conference Initiator at Proprietary EI

10.2.1.1.4 Ad Hoc Conference Scenario 4: AS-SIP Conference Server (Stand-Alone SUT) – Conference Initiator at AS-SIP EI

Figures 10.2-10 through 10.2-12, Ad Hoc Conference – AS-SIP Conference Server, Conference Initiator at AS-SIP EI, depict the call flow sequence for the Ad Hoc call scenario in which the Conference Server is a stand-alone AS-SIP conference server and the conference initiator is using an AS-SIP EI.

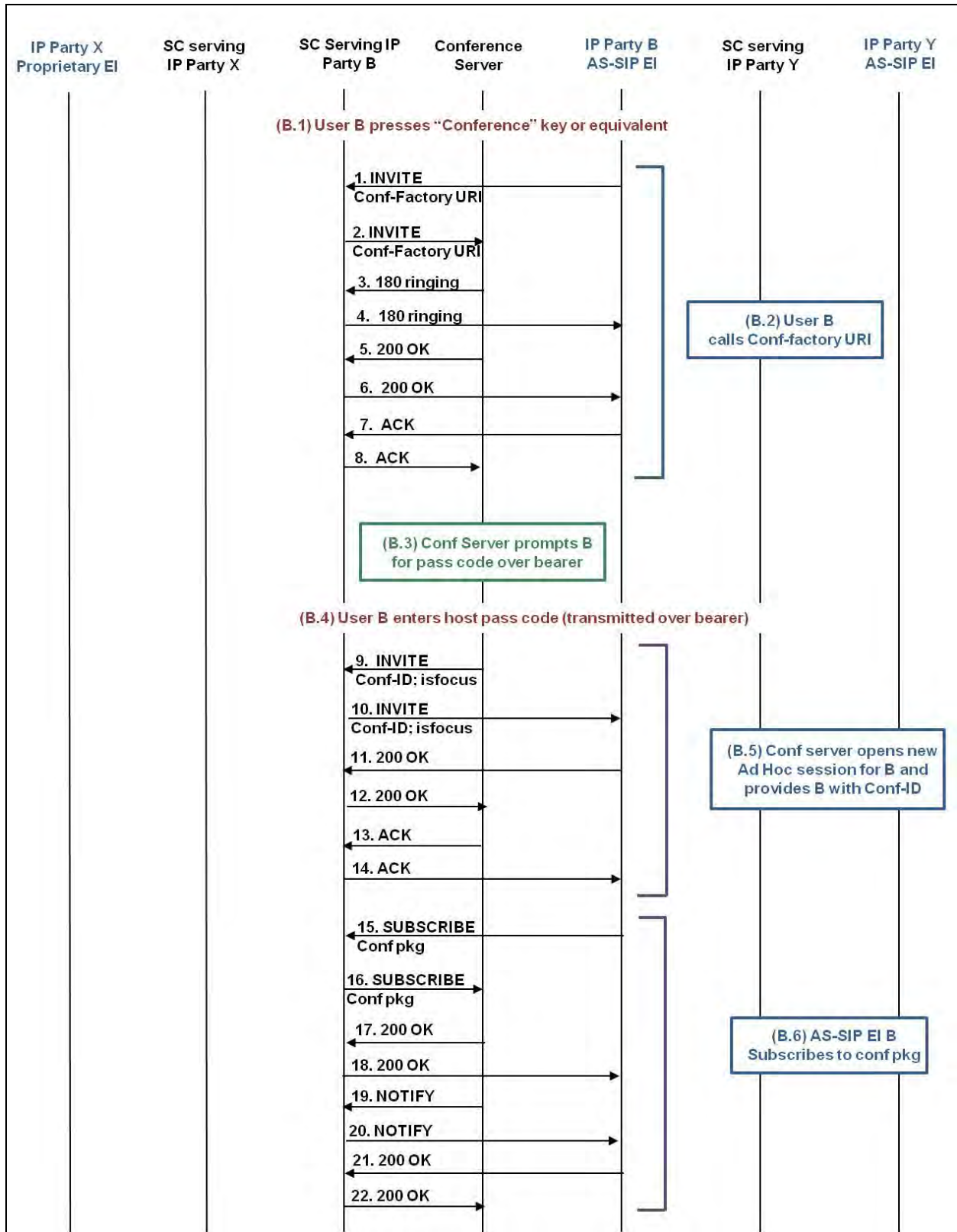

Figure 10.2-10. Ad Hoc Conference – AS-SIP Conference Server, Conference Initiator at AS-SIP EI (Steps 1–22)

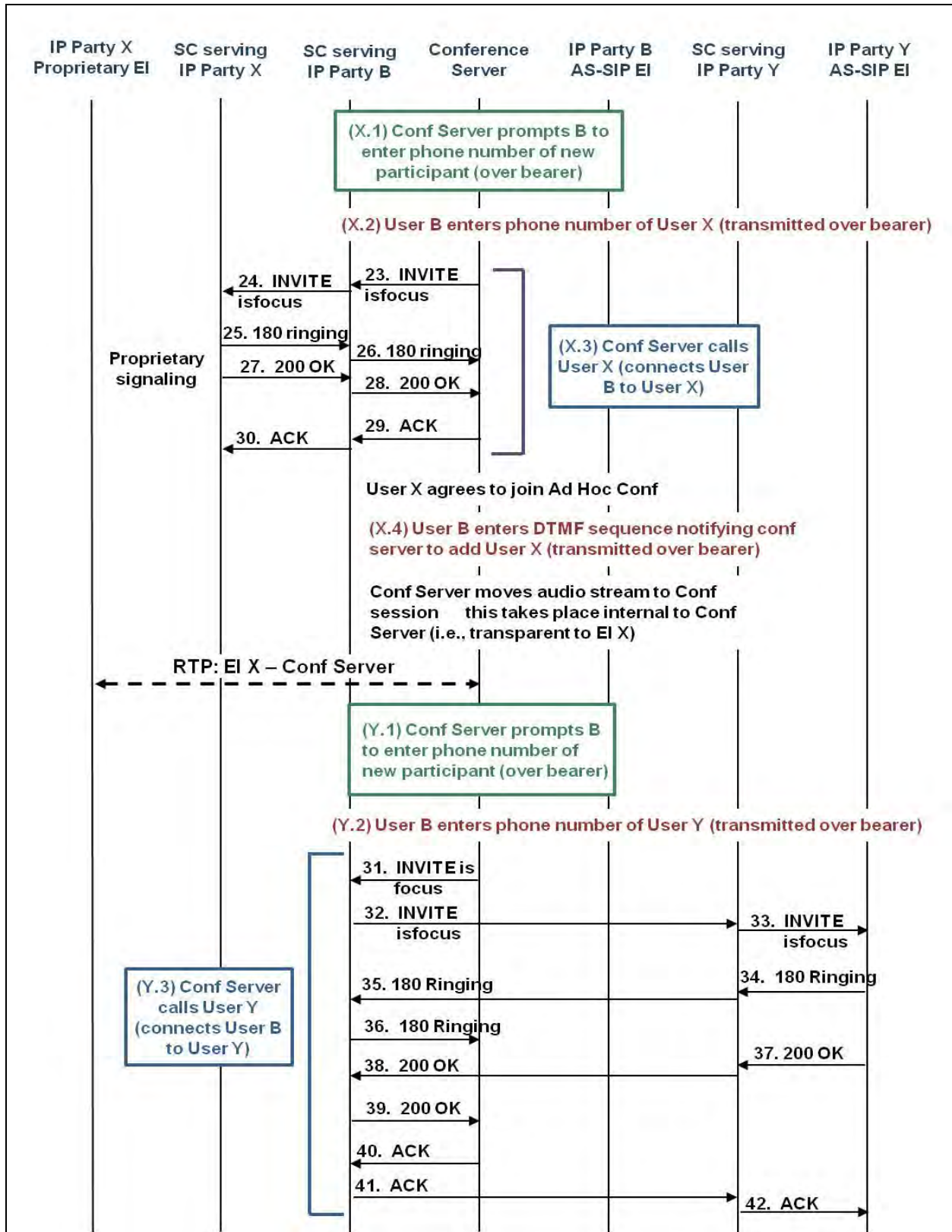

Figure 10.2-11. Ad Hoc Conference – AS-SIP Conference Server, Conference Initiator at AS-SIP EI (Steps 23–42)

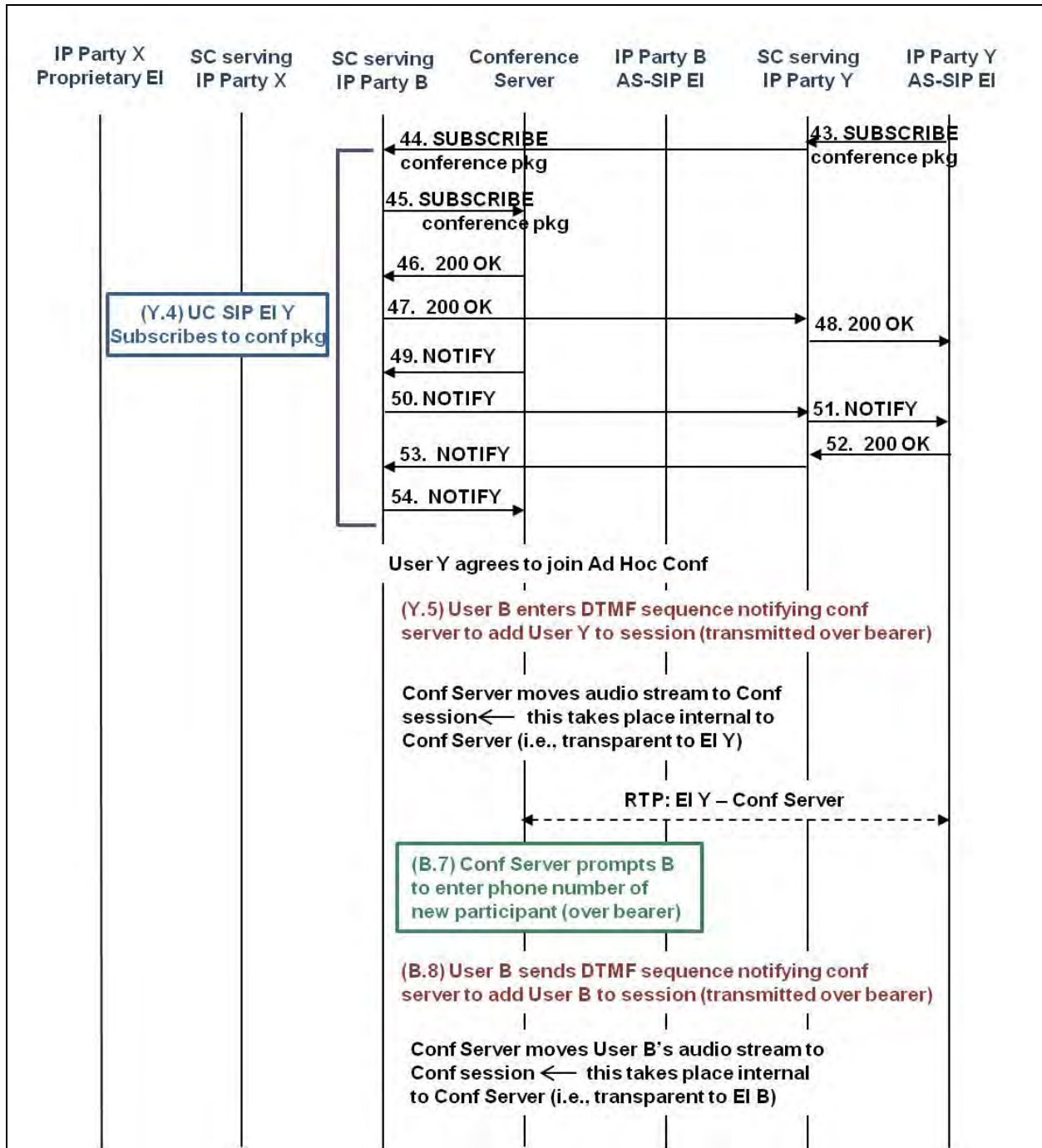

Figure 10.2-12. Ad Hoc Conference – AS-SIP Conference Server, Conference Initiator at AS-SIP EI (Steps 43–54)

ASAC

Each participant to an Ad Hoc audio conference that is located outside the enclave at which the conference server is situated causes the telephony call count at the SC of the enclave hosting the conference server to be incremented by 1.

10.2.2 Reservationless Audio Conference

The Reservationless Audio Conference (also known as a “Meet Me” Conference) enables users who are authorized to act as conference chairs to set up a conference anytime, on demand, with no reservation required, for up to a configured number of conferees. A dial-in number for the conference server and an access code are provided out-of-band to the conferees who then dial into the conference server to join the conference. A conference chair employs the same dial-in number and access code each time he or she sets up a conference. In addition, the dial-in number is generally shared among many of the conference chairs that use a given conference server.

Before a user can initiate a Reservationless Conference on a Conference Server a provisioning process takes place during which the user is added to the set of individuals authorized to act as conference chairs. As part of the provisioning process the user is furnished:

- A shared dial-in number for the Conference Server.
- An access code.
- A conference chair pin.

SIP-006520 The following properties of a reservationless audio conference **MUST** be configurable either by the users who are authorized to act as conference chairs or by administrators on behalf of users authorized to act as conference chairs:

1. Chair start/early start: The two configuration alternatives are as follows:
 - a. Chair start: Invitees who dial into the conference prior to the Chair are not placed into conference until the chair dials in and starts the conference. Conference server generally streams music to the invitees until the chair dials in and starts the conference.
 - b. Early start: Invitees who dial into the conference prior to the Chair are immediately placed into conference regardless of whether the Chair has dialed in and formally started the conference.
2. Conference termination: The two configuration alternatives are as follows:
 - a. Conference terminates when Chair disconnects from the conference.

NOTE: When this alternative is configured then the participants remaining on the conference when the Chair disconnects receive an announcement that the conference will now end and are then disconnected from the conference.
 - b. Conference continues for remaining participants when Chair disconnects from the conference.

NOTE: Conference ends when the last participant disconnects from the conference.
3. Participant ingress/egress tone: The two configuration alternatives are as follows:

- a. Tone is played to alert conference attendees when a participant enters or leaves the conference.
 - b. No tone is played when a participant enters or leaves the conference.
4. Maximum number of allowed conferees: This number is provisioned by an administrator and is not generally configurable directly by the user (i.e., chair).

SIP-006530 When implementing a reservationless audio conference, the basic call flow for conferees **MUST** proceed in accordance with the following event sequence:

At some point prior to the start time for the reservationless conference, the conferees receive the dial-in number and access code for the conference by an out of band means (e.g., e-mail, text message, IM).

1. Each conferee calls the conference server using the dial-in number provided previously by out of band means.
2. A standard call set-up (INVITE, 180 Ringing, 200 OK, ACK) establishes a 2-way SRTP audio bearer between the conferee EI and the conference server.

NOTE: If the conference server supports the “isfocus” feature tag then the conference server adds the ‘isfocus’ tag to the contact header.

3. The conference server prompts the conferee for the access code over the SRTP audio bearer stream.
4. The conferee enters the access code into the EI and the access code is transmitted as DTMF tones over the SRTP audio bearer to the conference server per RFC 4733 RTP Payload for DTMF Digits, Telephony Tones, and Telephony Signals.
5. (Optional) The conference server **MAY** prompt the caller over the SRTP audio bearer to perform a DTMF input to notify the conference server that the caller is actually the conference Chair.

NOTE: Vendors are not precluded from designing the call flow to include an additional passcode request over the SRTP audio bearer and DTMF response from the caller for added security purposes. The additional passcode would have been previously sent to the conferees by out of band means.

- a. If the conference is configured for “chair start,” then:
 - (1) If the chair has already dialed in and started the conference, the conference server places the conferee into the conference.
 - (2) If the chair has not yet started the conference, the conference server does not place the conferee into the conference and generally plays music over the audio bearer. When the chair dials in and starts the conference then the conference server moves the conferee’s audio bearer to the conference. Movement of the audio bearer to the

conference occurs within the conference server and does not involve signaling between the conference server and the EI of the conferee.

- (3) If the conference is configured for 'early start' then the conference server immediately places the conferee into the conference regardless of whether the chair has dialed in and started the conference.
6. If the conferee's EI is conference aware, and the 200 OK response sent by the conference server included the "isfocus" feature tag in the Contact header, then the EI subscribes to the RFC 4575 SIP event package for conference state.

NOTE: It is permissible for the conference-aware EI to subscribe to the RFC 4575 SIP event package for conference state at any time after the completion of Step 2.

SIP-006540 When implementing a reservationless audio conference, the basic call flow for the conference chair **MUST** proceed in accordance with the following event sequence:

(Steps 1–5 are identical for both the conferee and the conference chair.)

1. The conference chair calls the conference server using the dial-in number for the conference server.
2. A standard call set-up (INVITE, 180 Ringing, 200 OK, ACK) establishes a 2-way SRTP audio bearer between the conference chair EI and the conference server.

NOTE: If the conference server supports the "isfocus" feature tag then the conference server adds the 'isfocus' tag to the contact header.

3. The conference server prompts the conference chair for the access code over the SRTP audio bearer stream.
4. The conference chair enters the access code into the EI and the access code is transmitted as DTMF tones over the SRTP audio bearer to the conference server per RFC 4733 RTP Payload for DTMF Digits, Telephony Tones, and Telephony Signals.
5. (Optional) The conference server **MAY** prompt the conference chair over the SRTP audio bearer to perform a DTMF input to notify the conference server that the caller is actually the conference Chair.

NOTE: Vendors are not precluded from designing the call flow to include an additional passcode request over the SRTP audio bearer and DTMF response from the caller for added security purposes. The additional passcode would have been previously provisioned by or on behalf of the chair and known to the chair.

6. The conference chair enters the required DTMF input intended to indicate to the conference server that the caller is the conference chair and the conference chair enters the conference chair PIN.
7. The conference server may either:

- a. Require the conference chair to send a specified DTMF input to start the conference and when the conference chair sends the DTMF input the conference server places the conference chair into the conference or
 - b. Immediately start the conference and place the conference chair into the conference.
8. If the conference is configured for “chair start” then the conference server moves the audio bearer of all dialed-in conferees to the conference. Movement of the audio bearer to the conference occurs within the conference server and does not involve signaling between the conference server and the EIs of the dialed-in conferees.
9. If the chair’s EI is conference aware and the Contact header of the 200 response sent by the conference server included the “isfocus” feature tag then the EI subscribes to the RFC 4575 SIP event package for conference state.

NOTE: It is permissible for the conference-aware EI to subscribe to the RFC 4575 SIP event package for conference state at any time after the completion of Step 2.

10.2.2.1 Call Flow Diagrams

Four call flow diagrams are presented depicting the establishment of Reservationless Audio Conferences per the event sequence defined in SIP-006530 and in SIP-006540. In each diagram the conference initiator is party B. Each call flow depicts party B adding user X located at a proprietary IP EI and user Y located at an AS-SIP EI.

10.2.2.1.1 Reservationless Conference Scenario 1: Conference Server Within SC SUT – Conference Chair at Proprietary EI

In [Figures 10.2-13](#) and [10.2-14](#), Reservationless Conference – Conference Server within SC SUT, Conference Chair at Proprietary EI, the conference server is a component of the SC (i.e., conference server is within the SC SUT) and the Chair is using a proprietary EI. One conferee dials in before the Chair and hears music until the Chair dials in and starts the conference where the conferee is placed into the conference. One conferee dials in after the Chair has started the session and is immediately placed into the conference.

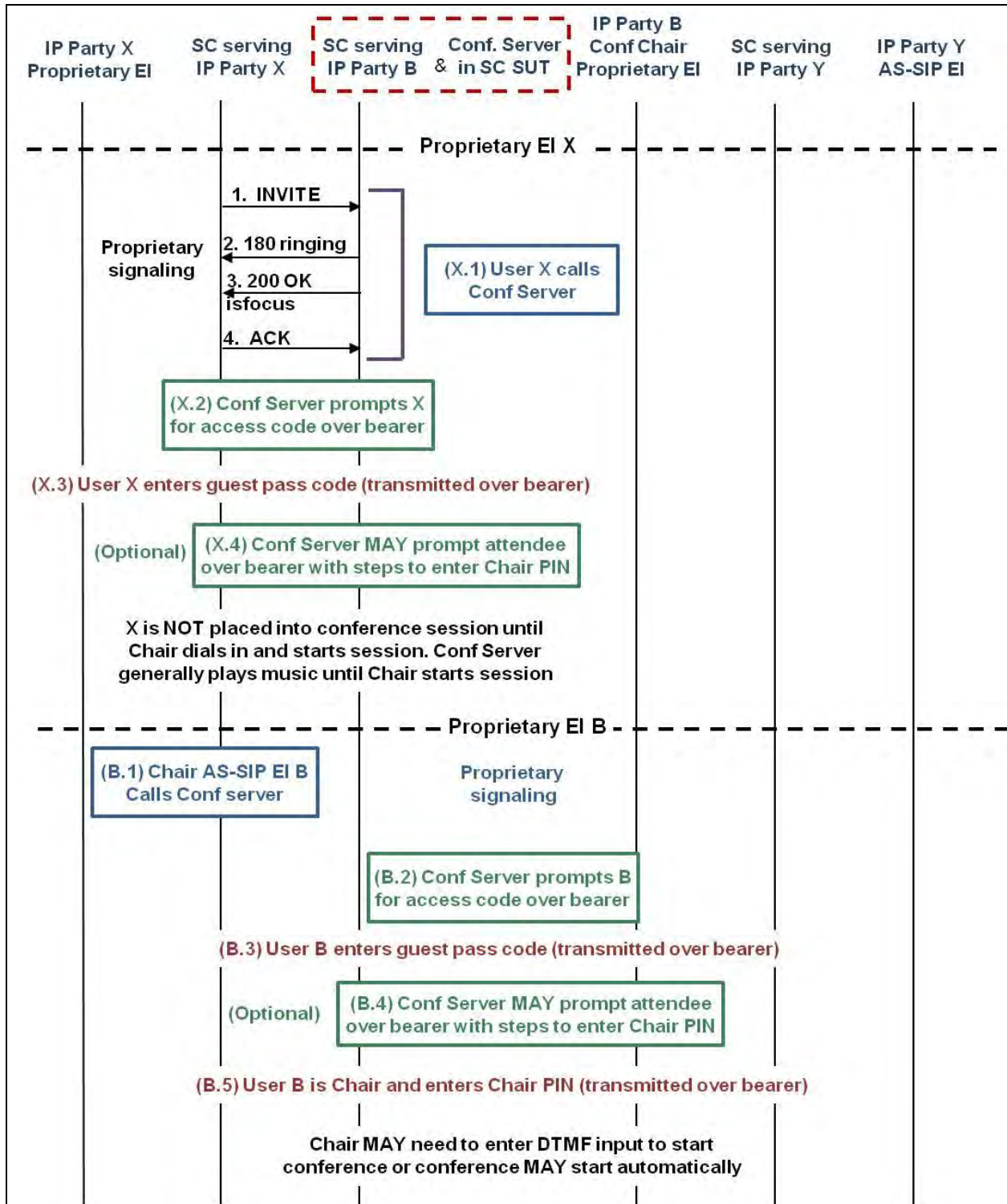

Figure 10.2-13. Reservationless Conference – Conference Server Within SC SUT, Conference Chair at Proprietary EI (Steps 1–4)

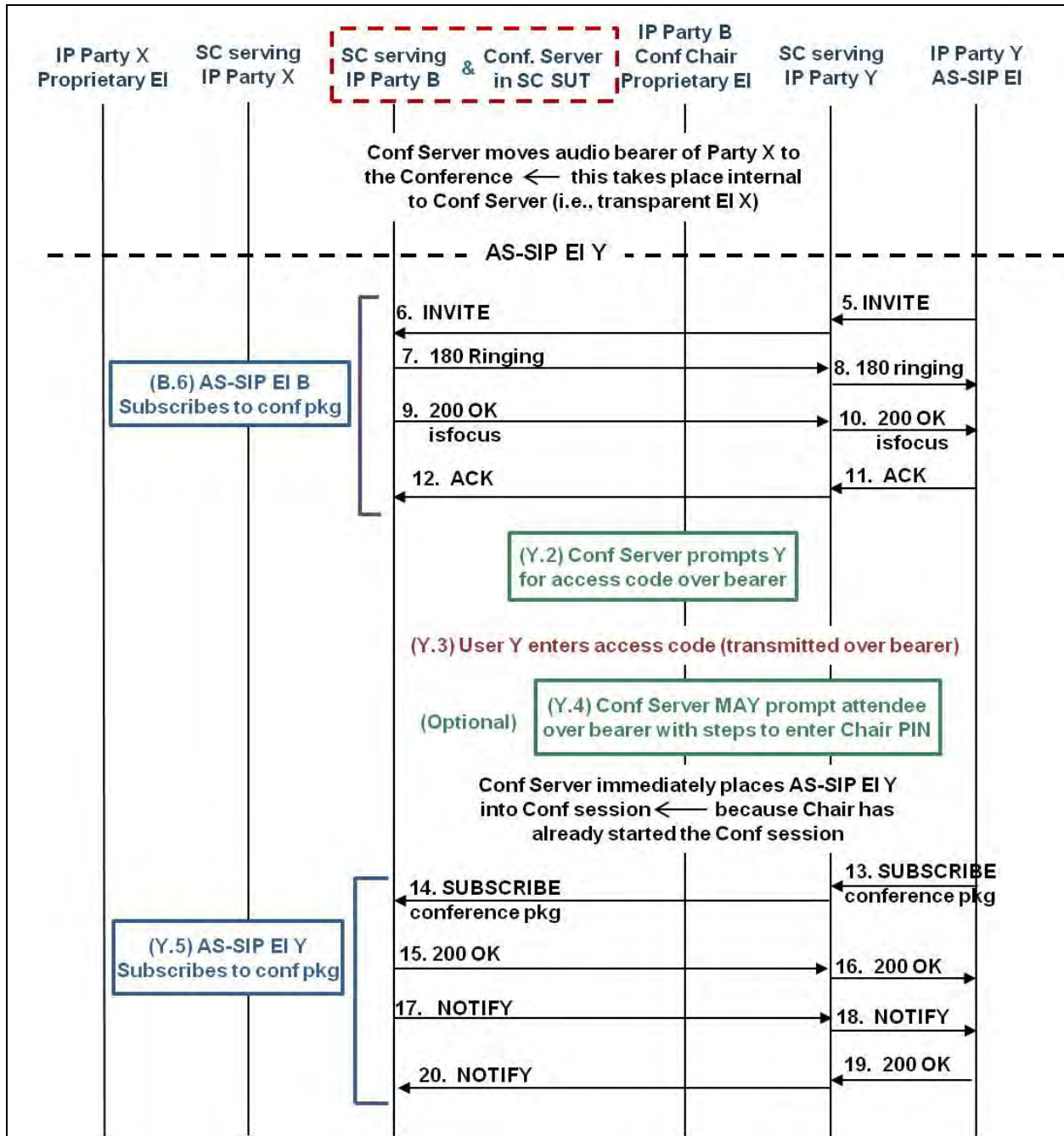

Figure 10.2-14. Reservationless Conference – Conference Server Within SC SUT, Conference Chair at Proprietary EI (Steps 5–20)

10.2.2.1.2 Reservationless Conference Scenario 2: Conference Server Within SC SUT – Conference Chair at AS-SIP EI

In [Figures 10.2-15](#) and [10.2-16](#), Reservationless Conference – Conference Server within SC SUT, Conference Chair at AS-SIP EI, the conference server is a component of the SC (i.e., conference server is within the SC SUT) and the Chair is using an AS-SIP EI. One conferee

dials in before the Chair and hears music until the Chair dials in and starts the conference and the conferee is placed into the conference. One conferee dials in after the Chair has started the session and is immediately placed into the conference.

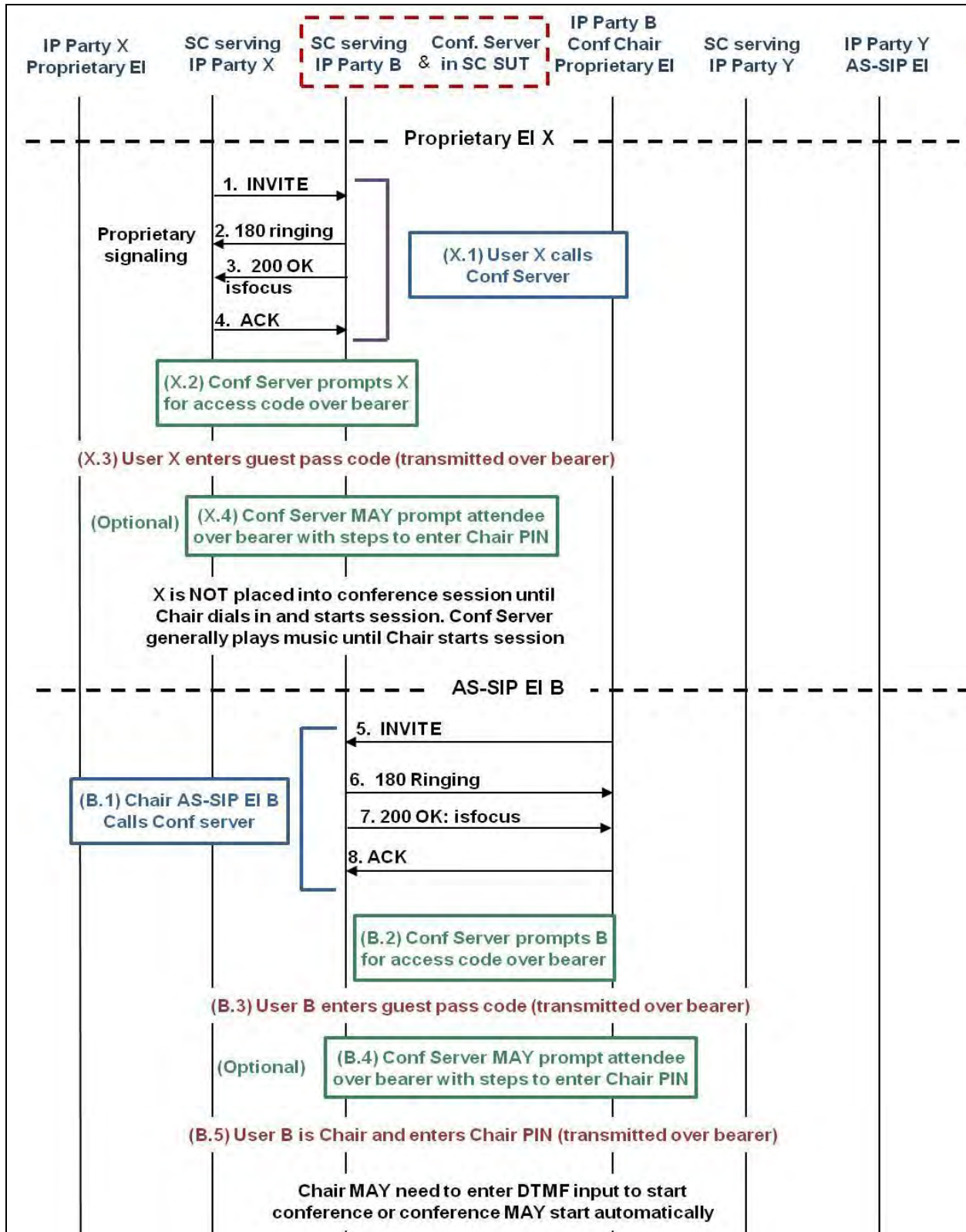

Figure 10.2-15. Reservationless Conference – Conference Server Within SC SUT, Conference Chair at AS-SIP EI (Steps 1–8)

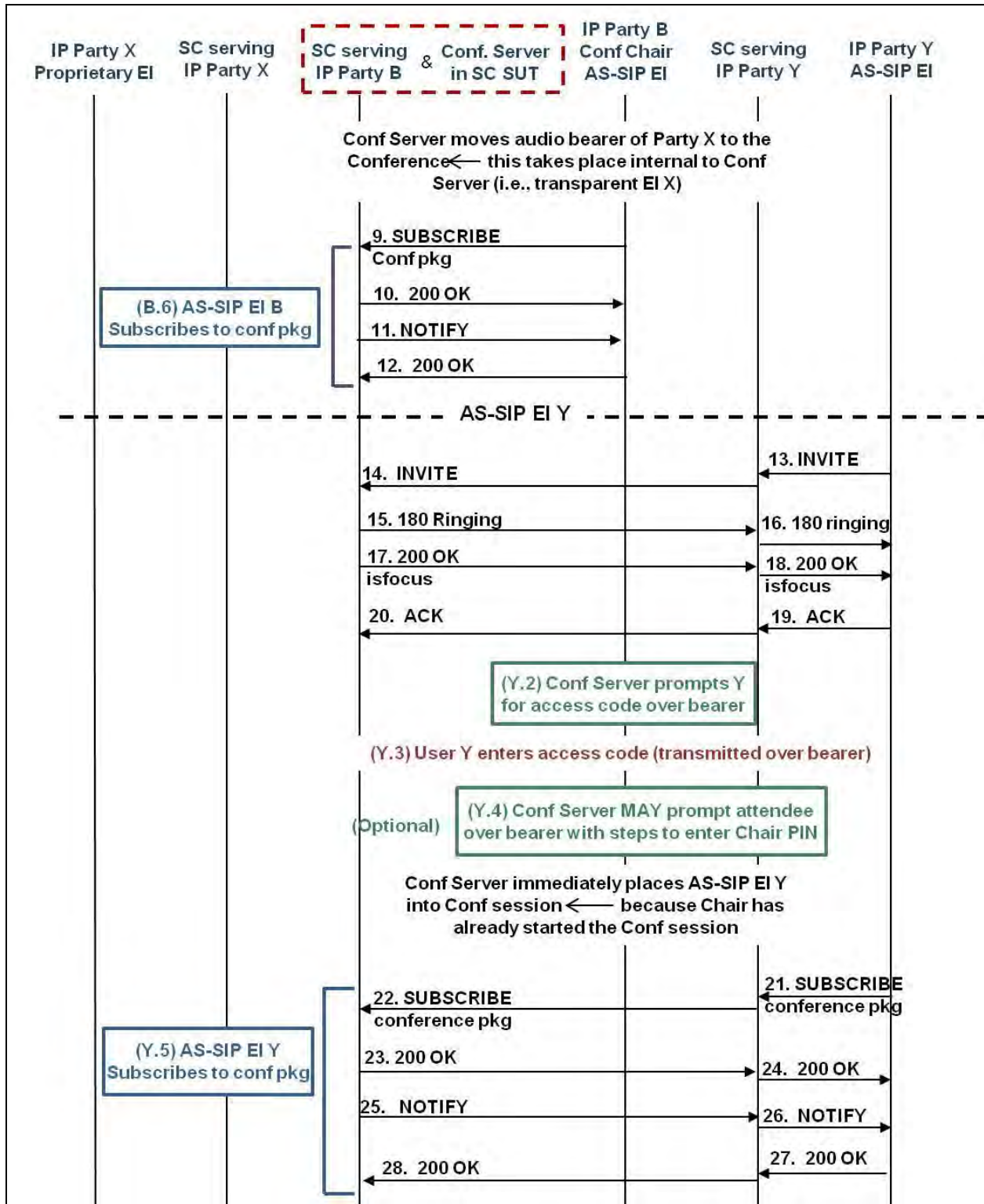

Figure 10.2-16. Reservationless Conference – Conference Server Within SC SUT, Conference Chair at AS-SIP EI (Steps 9–28)

*10.2.2.1.3 Reservationless Conference Scenario 3: AS-SIP Conference Server
(Stand-Alone SUT) – Conference Chair at Proprietary EI*

In [Figures 10.2-17](#) and [10.2-18](#), Reservationless Conference – AS-SIP Conference Server, Conference Chair at Proprietary EI, the conference server is an AS-SIP conference server connected to the SC over an AS-SIP interface and the Chair is using a proprietary EI. Two conferees dial in before the Chair starts the conference and the conferees hear music until the Chair dials in and starts the conference whereupon the two conferees are placed into the conference.

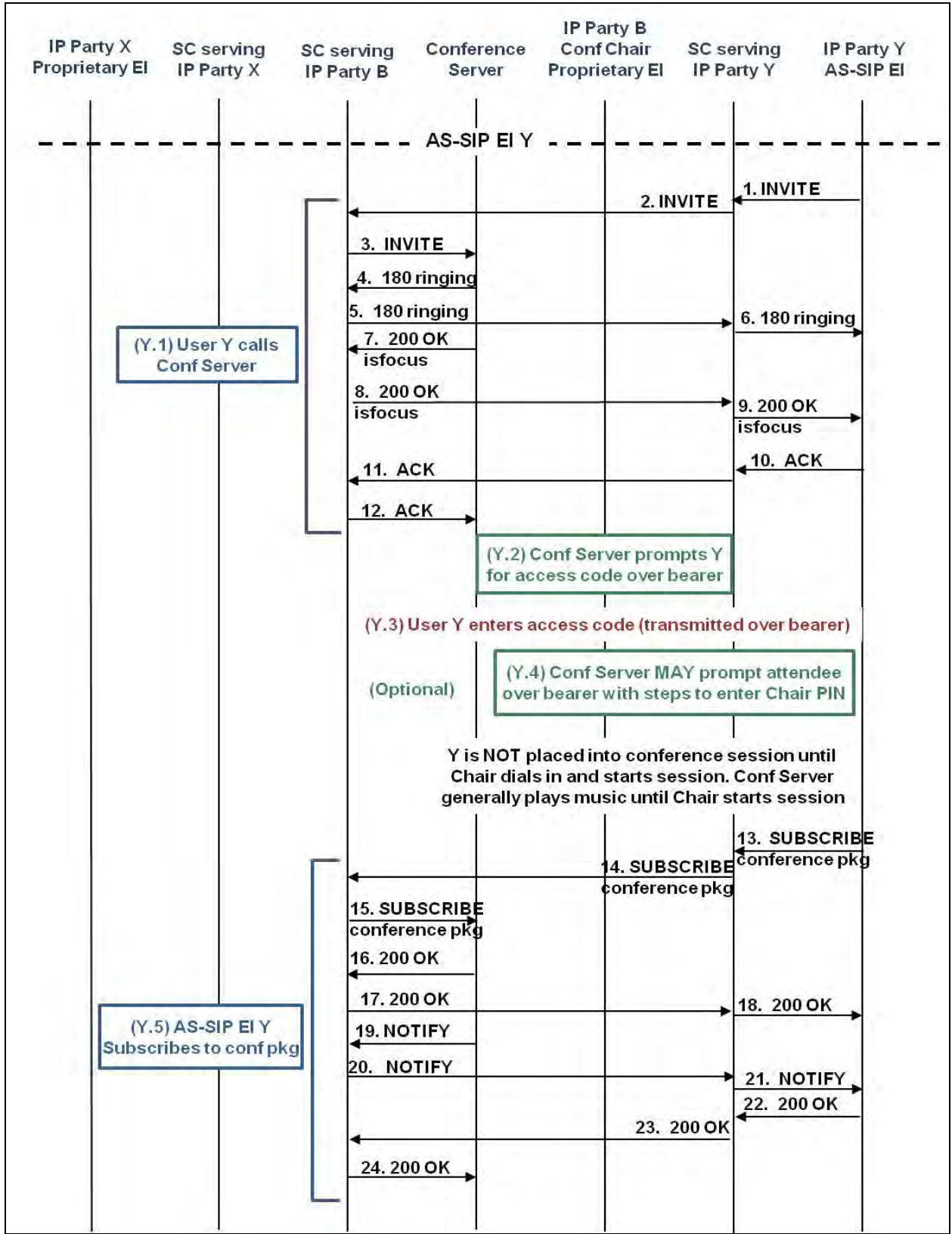

Figure 10.2-17. Reservationless Conference – AS-SIP Conference Server, Conference Chair at Proprietary EI (Steps 1–24)

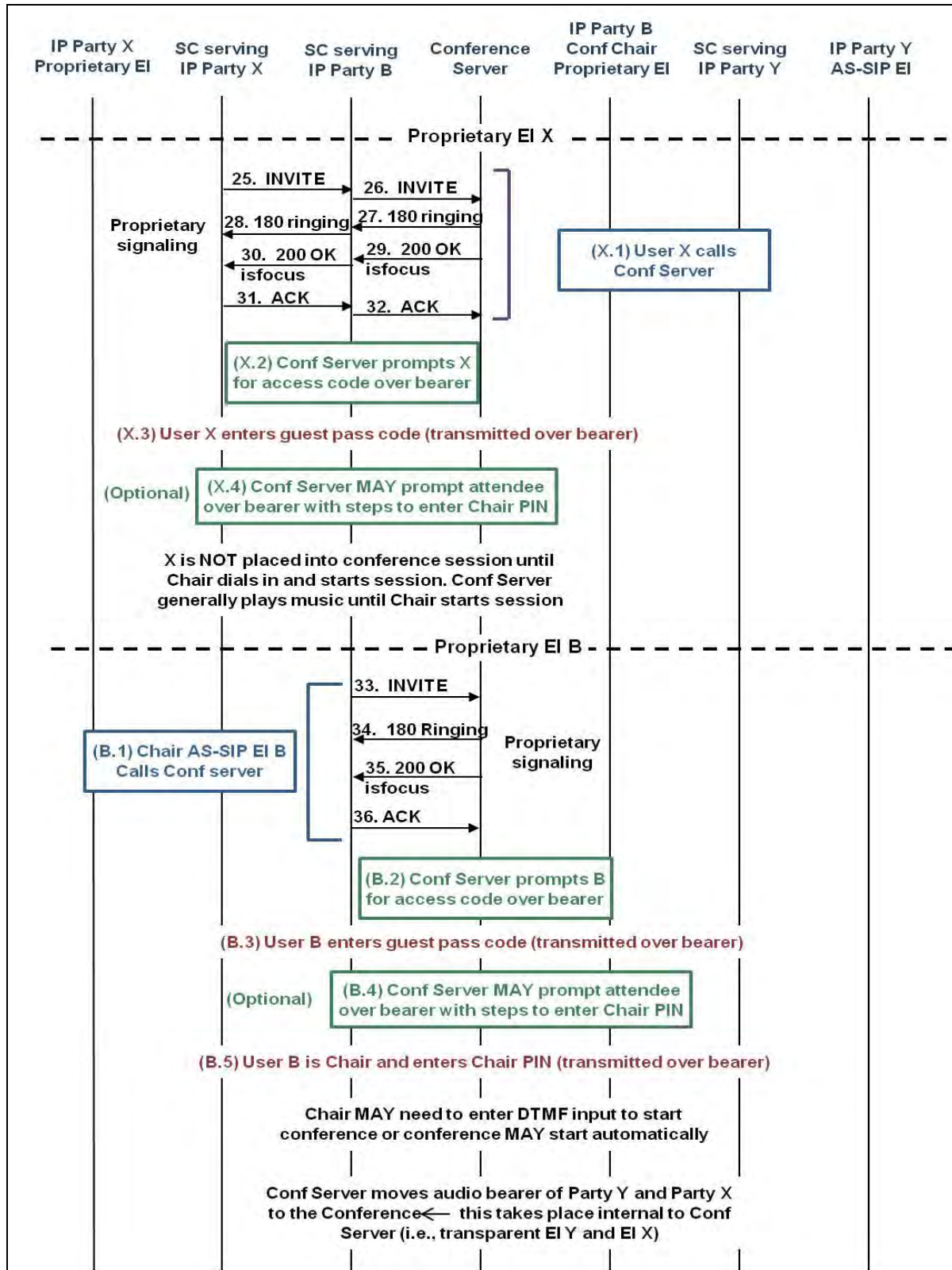

Figure 10.2-18. Reservationless Conference – AS-SIP Conference Server, Conference Chair at Proprietary EI (Steps 25–36)

*10.2.2.1.4 Reservationless Conference Scenario 4: AS-SIP Conference Server
(Stand-Alone SUT) – Conference Chair at AS-SIP EI*

In [Figures 10.2-19](#) through [10.2-21](#), Reservationless Conference – AS-SIP Conference Server, Conference Chair at Proprietary EI, the conference server is an AS-SIP conference server connected to the SC over an AS-SIP interface and the Chair is using an AS-SIP EI. Two conferees dial in before the Chair starts the conference and the conferees hear music until the Chair dials in and starts the conference whereupon the two conferees are placed into the conference.

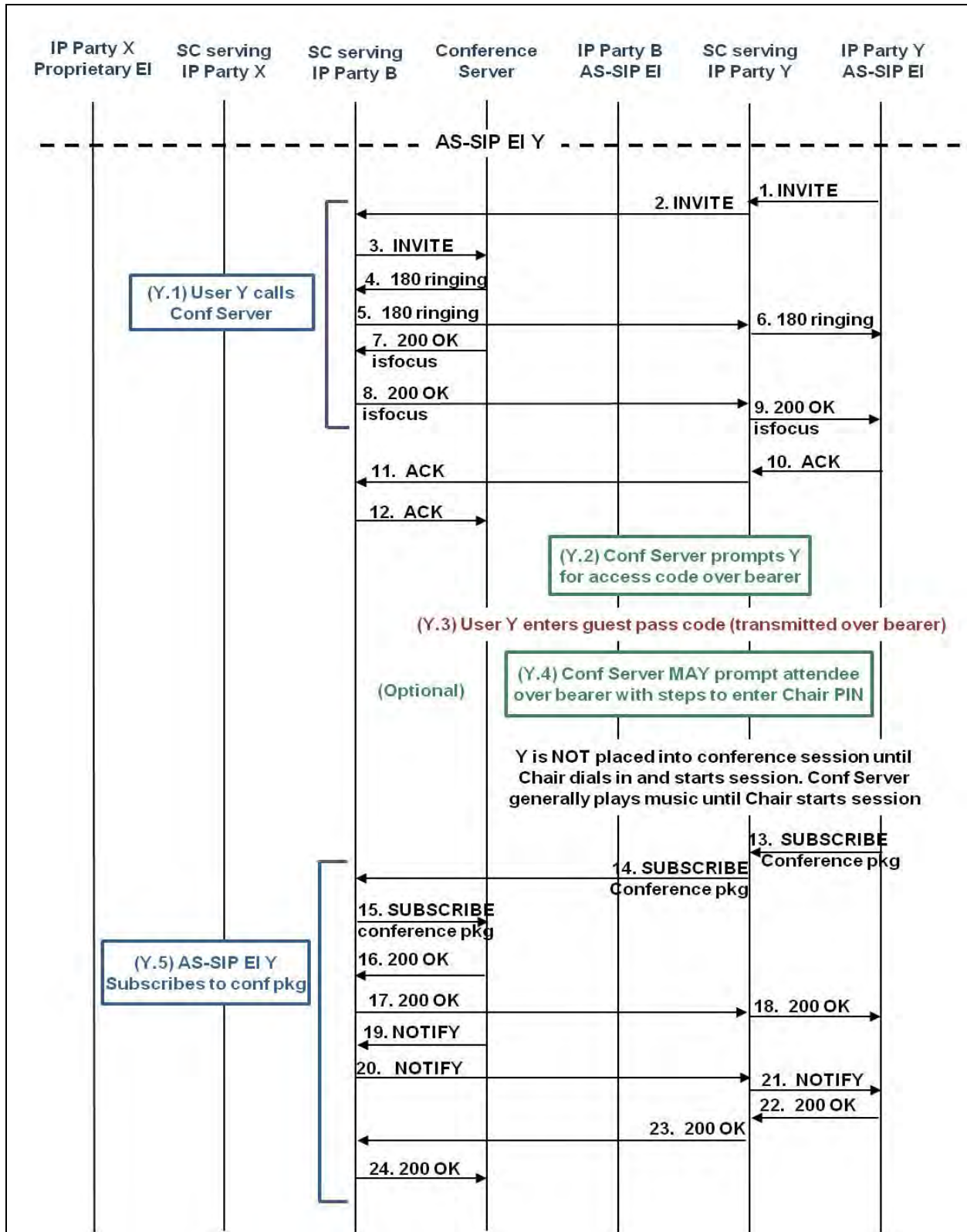

Figure 10.2-19. Reservationless Conference – AS-SIP Conference Server, Conference Chair at Proprietary EI (Steps 1–24)

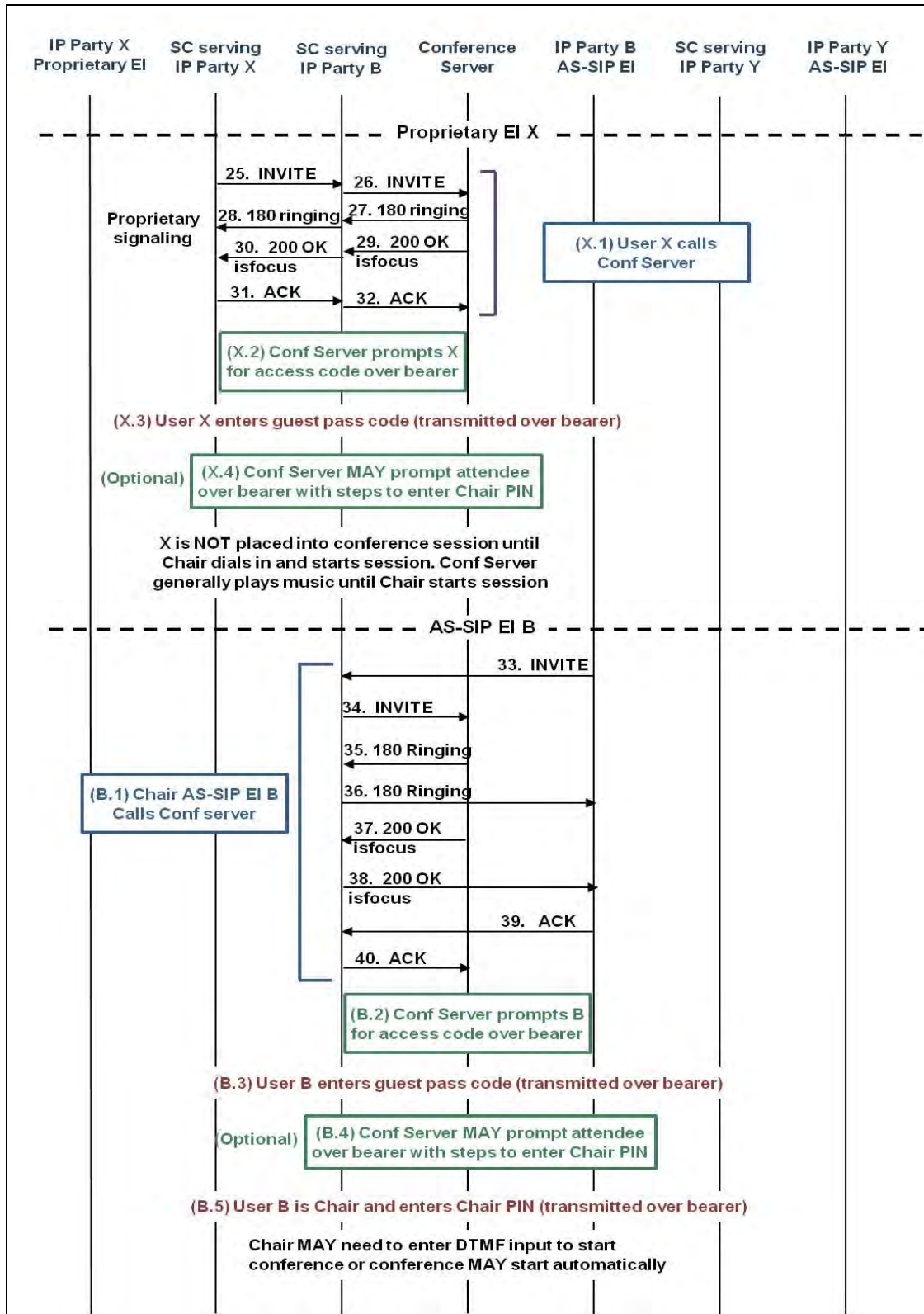

Figure 10.2-20. Reservationless Conference – AS-SIP Conference Server, Conference Chair at Proprietary EI (Steps 25–40)

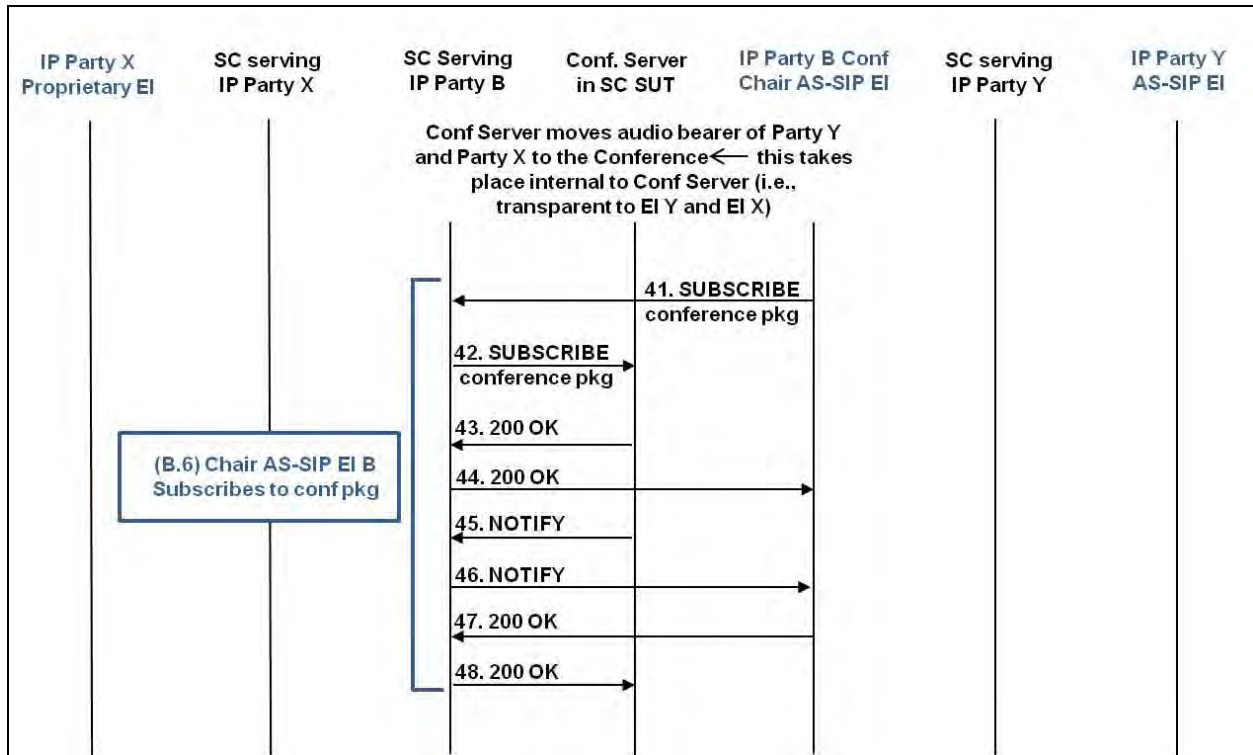

Figure 10.2-21. Reservationless Conference – AS-SIP Conference Server, Conference Chair at Proprietary EI (Steps 41–48)

ASAC

Each participant to a reservationless conference who is located outside the enclave at which the conference server is situated causes the telephony call count at the SC of the enclave hosting the conference server to be incremented by 1.

10.2.3 Scheduled Audio Conference

A Scheduled Audio Conference is scheduled in advance for a predefined date and time by the individual organizing the conference (“host”) using out of band means such as a web interface associated with the conference server. The host specifies the nature of the conference (i.e., Scheduled), the date and time for the conference, the identity of the participants for the conference, contact information for the conference participants, the intended duration of the conference, the purpose of the conference (i.e., topic(s) to be discussed), and the guest pass code to be used by the other participants to gain access to the conference. The conference server generates a conference-ID (i.e., unique conference URI) for the conference session and notifies each of the participants to the upcoming Scheduled conference of the identity of the host, the purpose of the conference, the conference-ID, date, time, and duration of the conference, and the guest pass code by an out-of-bands means, e.g., e-mail, text message, instant message.

At the appointed time, each meeting participant initiates a call request to the Conference-ID and the call flow sequence proceeds as follows:

1. At the designated date and time, the participants initiate a call request to the Conference-ID. The conference server initially accepts a point-to-point unicast session with each participant and if the conference server supports the “isfocus” feature tag then the conference server provides the “isfocus” feature tag in the Contact header of the 200 OK however technically the SRTP audio stream is not yet connected to the focus for the Scheduled session.
2. The conference server prompts the participant over the SRTP audio stream to input the pass code in order to be placed into the Scheduled session.
3. If the participant happens to be the host then the participant enters the host pass code. If the participant is not the host then the participant enters the guest pass code. The pass code is transmitted over the RTP audio stream per RFC 4733 RTP Payload for DTMF Digits, Telephony Tones, and Telephony Signals.

NOTE: If the participant fails to enter a valid pass code then the participant receives a configurable number of additional opportunities to do so (default=2 additional attempts). If the user fails to enter a valid pass code on each additional attempt then the conference server either terminates the call with the participant by sending a BYE or provides the caller with the opportunity to connect to an operator.

4. Assuming the participant enters a valid pass code then the conference server internally moves the RTP audio bearer stream with the participant’s EI to the focus for the conference session. This action is transparent to the participant. There is no need for the conference server to send a re-INVITE to the participant’s EI in order to change the IP address and UDP port for the RTP bearer stream.
5. If the participant’s EI is conference-aware and the 200 OK response from the conference server included the “isfocus” feature tag then the participant’s EI subscribes to the RFC 4575 SIP event package for conference state.

10.2.3.1 Call Flow Diagrams

The call flow between each participant to the Scheduled conference and the conference server is simple and straightforward. We have provided four diagrams to depict the situations in which the following occur:

1. The conference server is a component of the SC (i.e., conference server is within the SC SUT) and the host is on a proprietary EI (see [Figures 10.2-22](#) and [10.2-23](#)).
2. The conference server is a component of the SC (i.e., conference server is within the SC SUT) and the host is on an AS-SIP EI (see [Figures 10.2-24](#) and [10.2-25](#)).
3. The conference server is an AS-SIP conference server connected to the SC over an AS-SIP interface and the host is on a proprietary EI (see [Figures 10.2-26](#) and [10.2-27](#)).
4. The conference server is an AS-SIP conference server connected to the SC over an AS-SIP interface and the host is on an AS-SIP EI (see [Figures 10.2-28](#) through [10.2-30](#)).

NOTE: The relative order in which the host and the various guest participants enter the conference is not significant. Any number of guest participants may enter the Scheduled conference prior to the host and the guest participants are able to communicate with one another while waiting for the host to enter the conference session.

10.2.3.1.1 Scheduled Conference Scenario 1 – Conference Server Within SC SUT, Conference Host at Proprietary EI

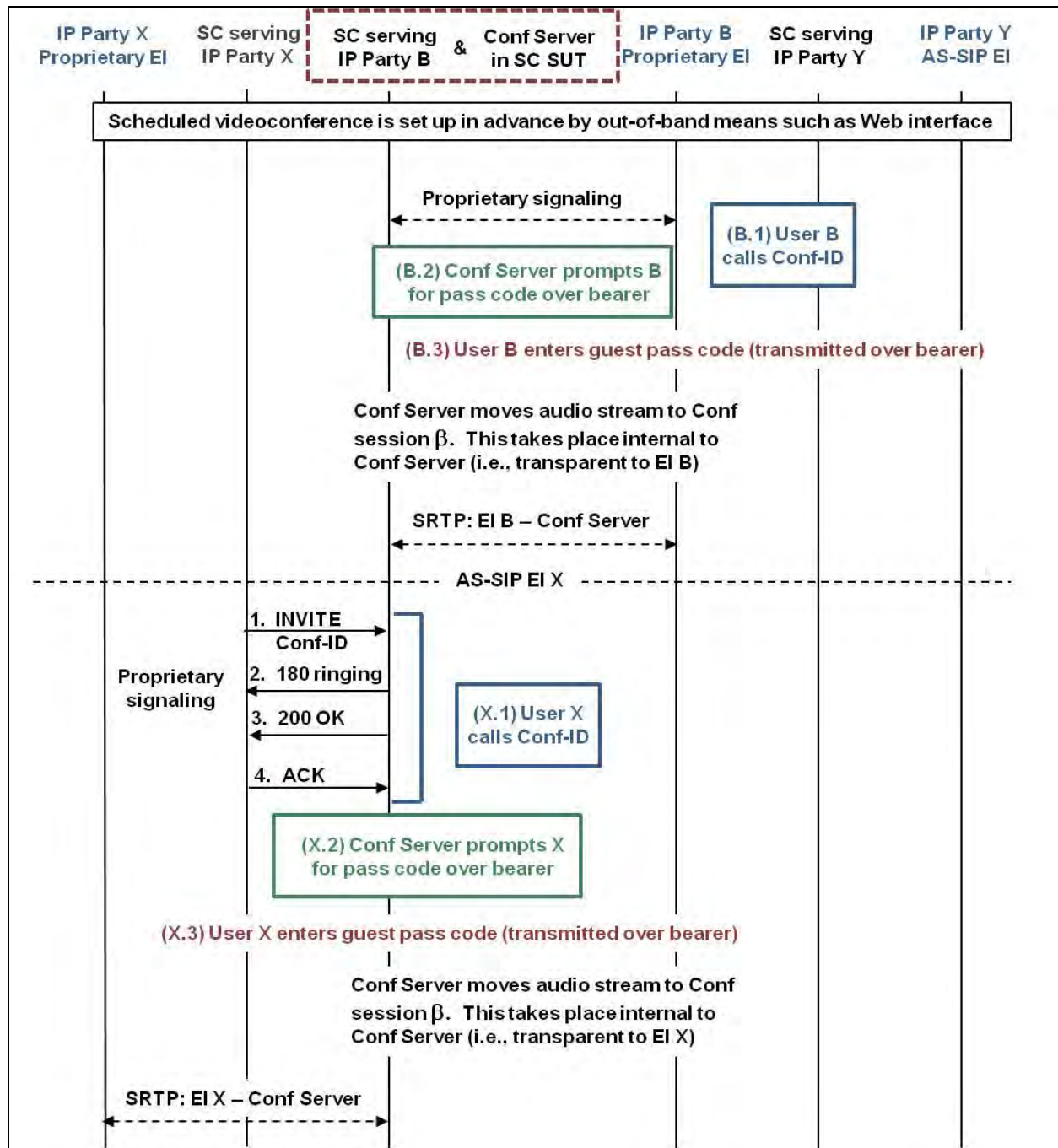

Figure 10.2-22. Scheduled Conference – Conference Server Within SC SUT, Host at Proprietary EI (Steps 1–4)

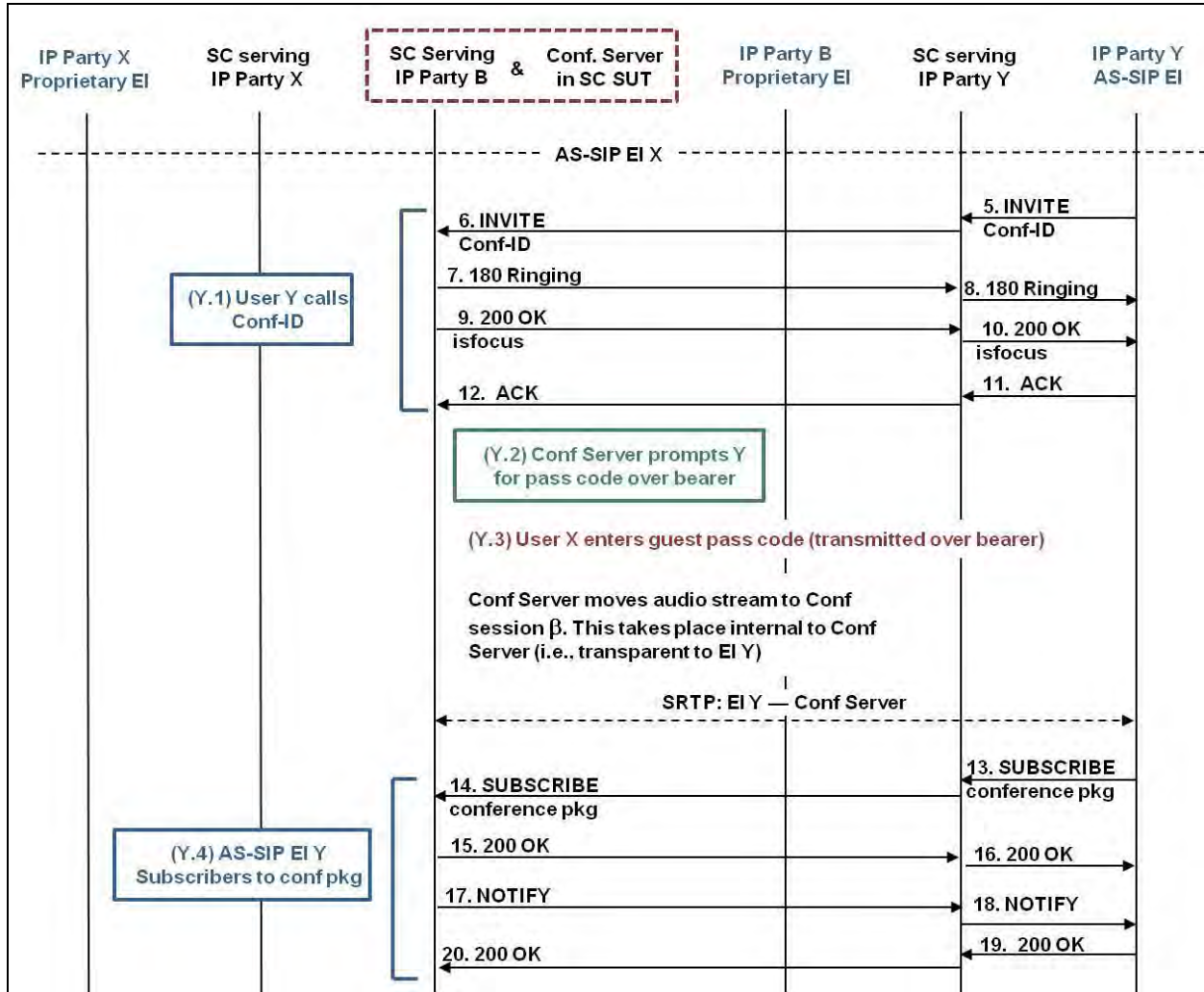

Figure 10.2-23. Scheduled Conference – Conference Server Within SC SUT, Host at Proprietary EI (Steps 5–20)

10.2.3.1.2 Scheduled Conference Scenario 2 – Conference Server Within SC SUT, Conference Host at AS-SIP EI

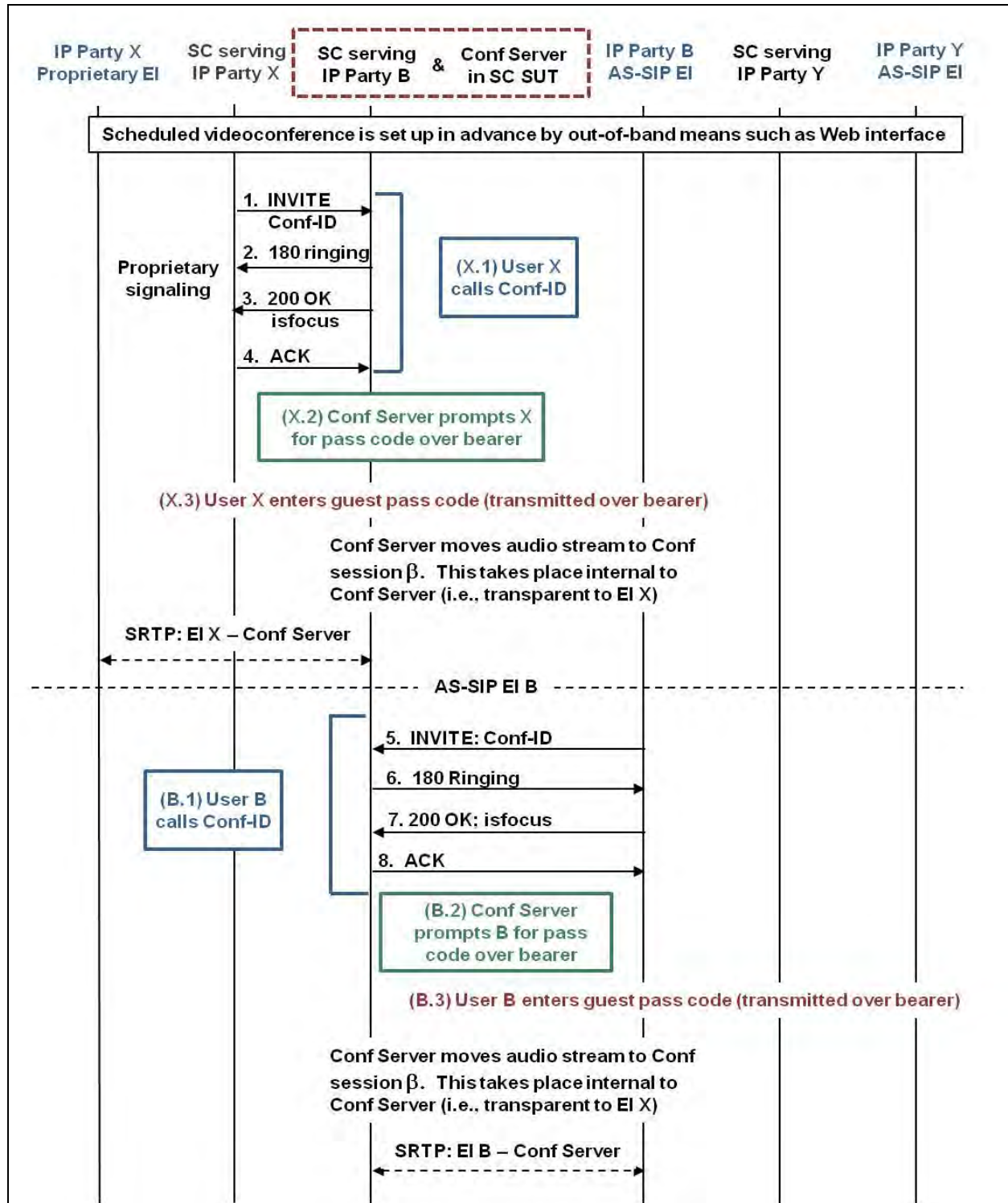

Figure 10.2-24. Scheduled Conference – Conference Server Within SC SUT, Host at AS-SIP EI (Steps 1–8)

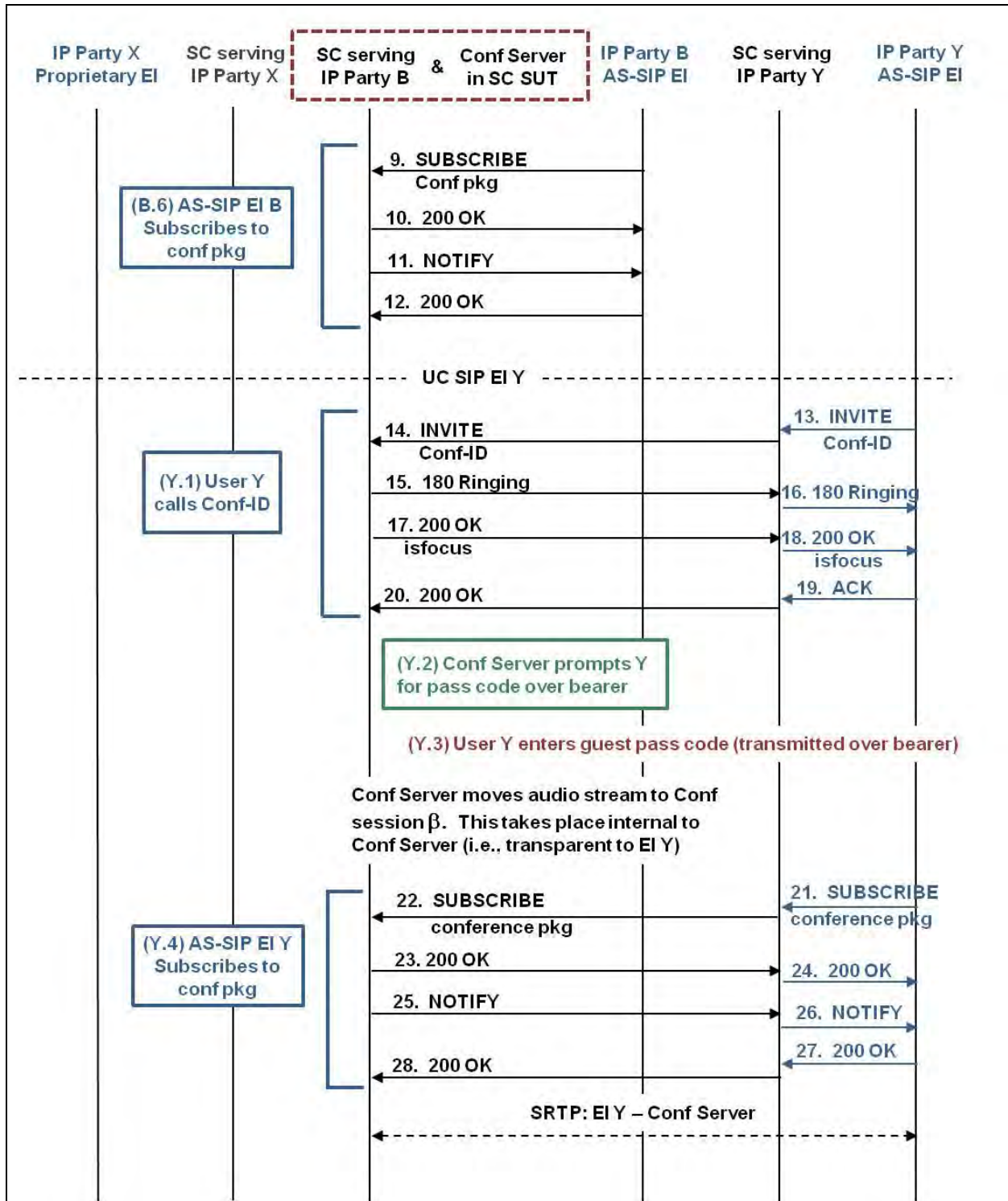

Figure 10.2-25. Scheduled Conference – Conference Server Within SC SUT, Host at AS-SIP EI (Steps 9–28)

10.2.3.1.3 Scheduled Conference Scenario 3 – AS-SIP Conference Server, (Stand-Alone SUT) – Conference Host at Proprietary EI

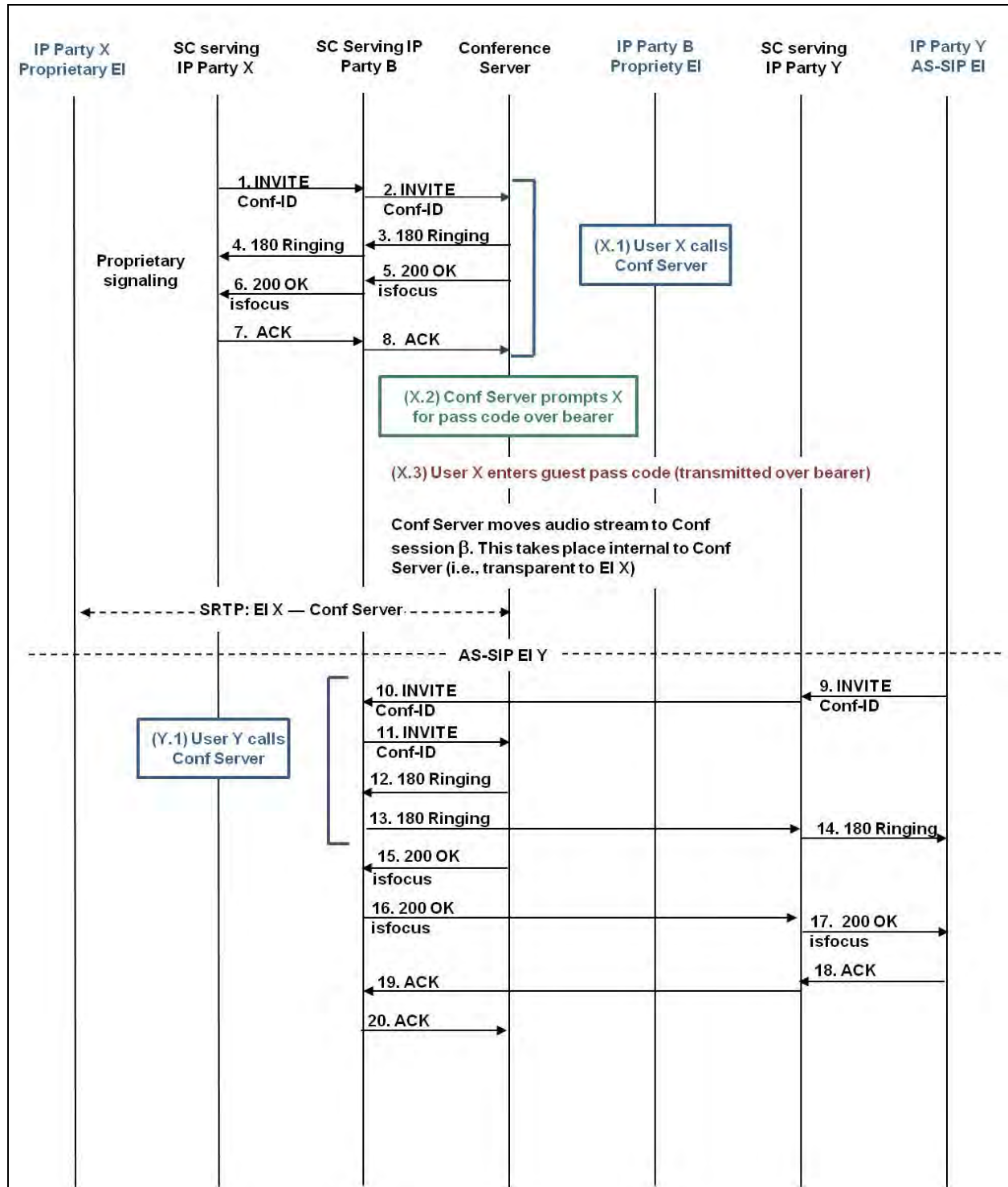

Figure 10.2-26. Scheduled Conference – AS-SIP Conference Server, Host at Proprietary EI (Steps 1–20)

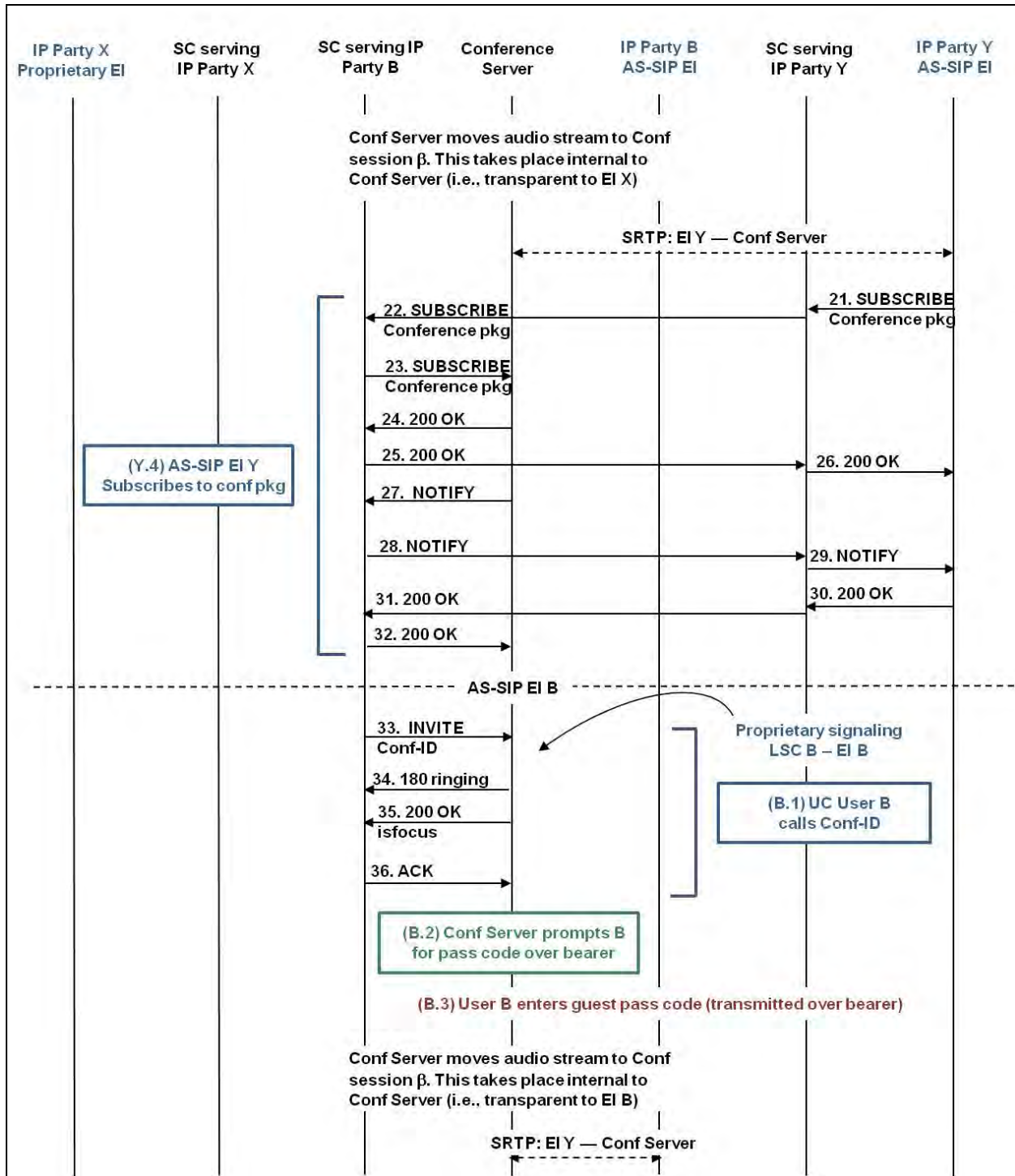

Figure 10.2-27. Scheduled Conference – AS-SIP Conference Server, Host at Proprietary EI (Steps 21–36)

10.2.3.1.4 Scheduled Conference Scenario 4 – AS-SIP Conference Server, (Stand-Alone SUT) Conference Host at AS-SIP EI

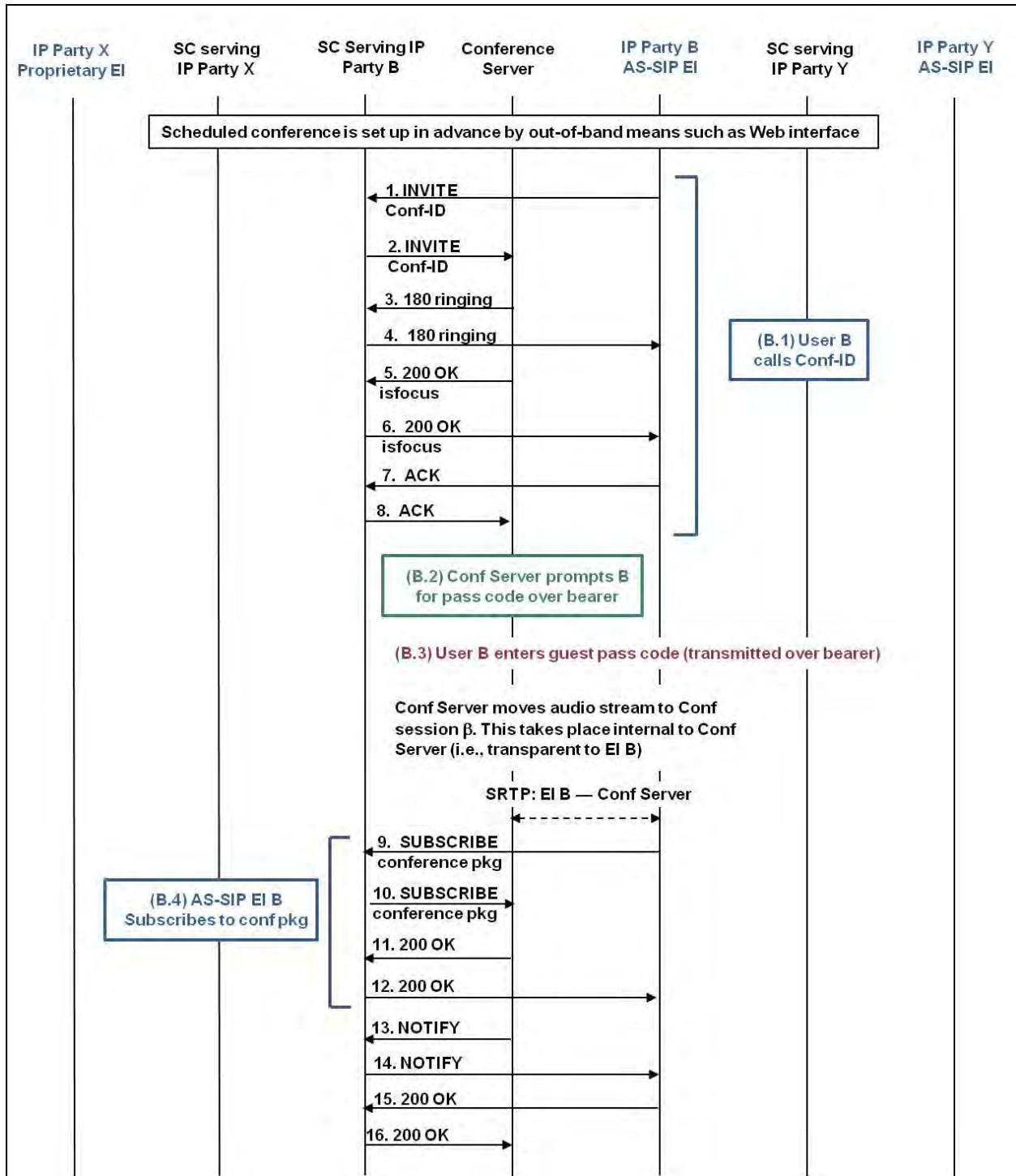

Figure 10.2-28. Scheduled Conference – AS-SIP Conference Server, Host at AS-SIP EI (Steps 1–16)

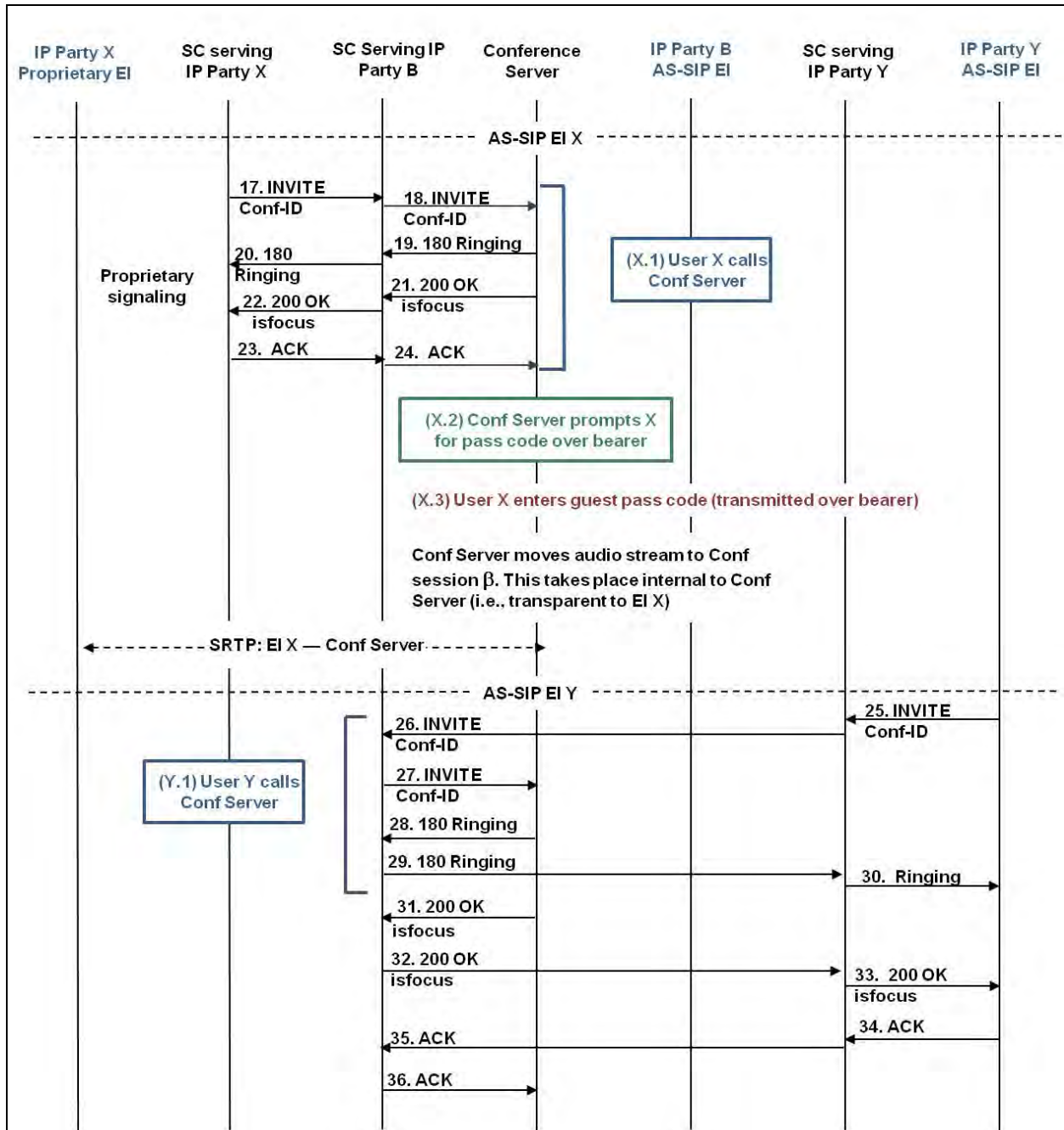

Figure 10.2-29. Scheduled Conference – AS-SIP Conference Server, Host at AS-SIP EI (Steps 17–36)

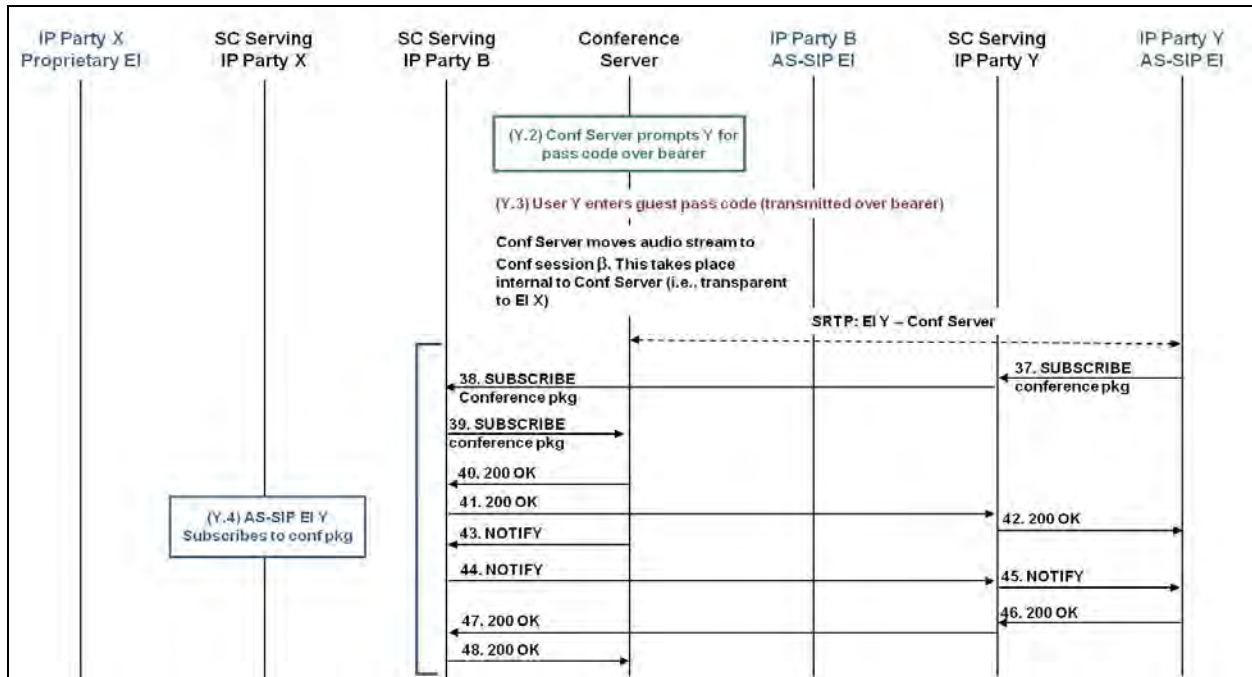

Figure 10.2-30. Scheduled Conference – AS-SIP Conference Server, Host at AS-SIP EI (Steps 37–48)

ASAC

Each participant to a Scheduled audio conference that is located outside the enclave at which the conference server is situated causes the telephony call count at the SC of the enclave hosting the conference server to be incremented by 1.

10.3 VIDEOCONFERENCE REQUIREMENTS

This section details the requirements for establishing a videoconference consisting of two or more videoconference EIs that establish RTP audio and video bearer with a videoconference server that operates as the focus for the videoconference session.

NOTE: As noted in [Section 10.1.1](#), the videoconference server can be implemented as a functional component within the SC SUT or as a stand-alone AS-SIP videoconference server connected to the SC (or SS) over an AS-SIP interface.

10.3.1 Videoconference EIs

SIP-006550 AS-SIP videoconference EIs MUST support at least 1 RTP audio stream, 2 concurrent RTP video streams and the Binary Floor Control Protocol (BFCP) over UDP.

SIP-006550.a [Optional] It is recommended but NOT required that AS-SIP videoconference EIs be conference-aware (i.e., support the SIP Event Package for Conference State [RFC 4575] and support the receipt/processing and generation of the

“isfocus” feature tag placed in the Contact header of the request or response per RFC 4579 Session Initiation Protocol [SIP] Call Control - Conferencing for User Agents).

SIP-006560 SIP videoconference EIs are only required to support a minimum of 1 RTP audio stream and 1 RTP video stream.

SIP-006560.a [Optional] SIP videoconference EIs MAY be conference-aware (i.e., support the SIP Event Package for Conference State [RFC 4575] and support the receipt/processing and generation of the “isfocus” feature tag placed in the Contact header of the request or response per RFC 4579 Session Initiation Protocol [SIP] Call Control - Conferencing for User Agents).

SIP-006570 Videoconference EIs that do not employ SIP or AS-SIP signaling are NOT required to support the SIP Event Package for Conference State (RFC 4575) or the “isfocus” feature tag (per RFC 4579). The SC serving videoconference EIs that do not employ SIP or AS-SIP signaling is NOT required to support the SIP Event Package for Conference State (RFC 4575) or the “isfocus” feature tag (per RFC 4579) on their behalf.

SIP-006580 SIP Role-Based Video Stream (RBVS)-compliant videoconference EIs MUST support at least 1 RTP audio stream, 2 concurrent RTP video streams, and BFCP over UDP.

SIP-006580.a SIP RBVS-compliant videoconference EIs MAY be conference-aware (i.e., support the SIP Event Package for Conference State [RFC 4575]).

SIP-006590 Proprietary (non-SIP) videoconference EIs are required to support a minimum of one RTP audio stream and one RTP video stream.

NOTE: Non-SIP proprietary EIs do NOT support BFCP and cannot be RBVS-compliant.

SIP-006600 The AS-SIP video conferencing EIs MUST support, at minimum, G.711 Pulse Code Modulation μ -law (PCMU) where PCMU has a static payload type value of 0 and a clock rate of 8000.

SIP-006610 It is RECOMMENDED that AS-SIP video conferencing EIs support other audio codecs in addition to G.711 PCMU. Recommended audio codecs include the following:

- G.722 where G.722 has a static payload type value of 9 and a clock rate of 8000.
- G.722.1 where G.722.1 has the encoding name “G7221,” a clock rate of 16000, and a standard bit rate of 24 Kbps or 32 Kbps.

An example of the sdp for G.722.1 with a bit rate of 24 Kbps is:

```
m=audio 32450 RTP/AVP 122
a=rtpmap:122 G7221/16000
a=fmtp:122 bitrate=24000
```

- G.729, where G.729 has the encoding name “G729”, a clock rate of 8000, and a standard bit rate of 8 Kbps
- G.729 Annex A (G.729A), where G.729A also has the encoding name “G729”, a clock rate of 8000, and a standard bit rate of 8 Kbps.

SIP-006620 [Conditional] If an AS-SIP video conferencing EI is intended for directly establishing video sessions with other video conferencing EIs (in addition to or in place of connectivity to a multipoint video conferencing unit), then the AS-SIP video conferencing EI **MUST** support, at minimum, the H.263-2000 codec.

SIP-006630 An AS-SIP video conferencing EI intended for connectivity with a Multipoint Conferencing Unit (MCU) **MUST** support at least one of the following video codecs:

- H.263-2000.
- H.264.
- H.261.

NOTE: At this time, we have only specified the “sdp” parameter details for H.263-1998, H.263-2000, H.264, and H.261.

10.3.2 Audio and Video Codecs

SIP-006640 The videoconference server **MUST** support, at minimum, the following audio codecs:

- G.711 PCMU where PCMU has a static payload type value of 0 and a clock rate of 8000.
- G.711 Pulse Code Modulation A-Law (PCMA) where PCMA has a static payload type value of 8 and a clock rate of 8000.
- G.722 where G.722 has a static payload type value of 9 and a clock rate of 8000.
- G.722.1 where G.722.1 has the encoding name “G7221,” a clock rate of 16000, and a standard bit rate of 24 Kbps or 32 Kbps.

An example of the sdp for G.722.1 with a bit rate of 24 Kbps is:

```
m=audio 32450 RTP/AVP 122
a=rtpmap:122 G7221/16000
a=fmtp:122 bitrate=24000
```

SIP-006650 An AS-SIP videoconference server **MUST** support, at minimum, the following video codecs:

- H.263-2000.
- H.264.
- H.261.

NOTE: The SDP parameter details for H.263-1998 are described in [Section 5.4.2](#), the SDP parameter details for H.263-2000 are described in [Sections 5.4.2](#) and [5.4.2.4](#), the SDP parameter details for H.264 are described in [Section 5.4.3](#), and the SDP parameter details for H.261 are described in [Section 5.4.1](#).

10.3.3 Role-Based Video Stream (RBVS)

In accordance with the best practices for RBVS, this UCR specifies requirements relating to the following:

- Assigning roles to media streams (e.g., designating the “main” video stream and the “Live” or “Presentation” media stream).
- Negotiating RBVS capabilities between AS-SIP videoconference EIs and a videoconference server; negotiating RBVS capabilities between RBVS-compliant videoconference SIP EIs and a videoconference server.
- Dynamically managing the role of “presenter” for each “Presentation” video stream.

10.3.3.1 Assignment of Roles to Media Streams

The assignment of roles to media streams is conducted in the AS-SIP signaling plane as part of the SDP offer/answer exchange that establishes the video session between the AS-SIP videoconference EI (or RBVS-compliant SIP videoconference EI) and the videoconference server. The SDP media level attribute “content” (RFC 4796) is employed to assign roles to media streams.

SIP-006660 AS-SIP videoconference EIs, RBVS-compliant SIP videoconference EIs, and videoconference servers MUST support the generation of the SDP “content” media-level attribute and the receipt/processing of the SDP “content” media-level attribute in accordance with RFC 4796.

The Augmented Backus-Naur Form for the “content” attribute is as follows:

content-attribute	= “a=content:” mediacnt-tag
mediacnt-tag	= mediacnt *(“,” mediacnt)
mediacnt	= “slides”/ “speaker”/ “sl”/ “main”/ “alt”/ mediacnt-ext
mediacnt-ext	= token

SIP-006670 Of the five predefined “content” attribute values defined in RFC 4796 (i.e., slides, speaker, sl, main, alt) AS-SIP videoconference EIs, RBVS-compliant SIP videoconference EIs, and videoconference servers MUST support the generation and receipt/processing of the following:

- Main: The media stream is taken from the main source. This video stream corresponds to the “main” channel in H.239.

- Slides: A media stream that includes presentation slides. This is similar to the “presentation” role in H.239.

NOTE: AS-SIP videoconference EIs, RBVS-compliant SIP videoconference EIs, and videoconference servers only make use of the “main” and “slides” “content” attribute values.

SIP-006680 An SDP answer MAY contain “content” attributes even if none were present in the offer.

SIP-006690 An SDP answer MAY contain no “content” attributes even if one or more “content” attribute(s) were present in the offer.

The following is an example of the SDP session description that uses the “content” attribute:

```
v=0
o=Alice 292742730 29277831 IN IP4 131.163.72.4
s=-
c=IN IP4 131.164.74.2
t=0 0
m=audio 25000 RTP/AVP 0
m=video 35000 RTP/AVP 31
a=content:main
m=video 35100 RTP/AVP 31
a=content:slides
```

SIP-006700 AS-SIP videoconference EIs, RBVS-compliant SIP videoconference EIs and videoconference servers MUST support the generation of the SDP “label” media-level attribute and the receipt and processing of the SDP “label” media-level attribute in accordance with RFC 4574.

The Augmented Backus-Naur Form for the “label” attribute is as follows:

```
label-attribute = "a=label:" pointer
pointer = token
token = 1*(token-char)
token-char = %x21/ %x23-27/ %x2A-2B/ %x2D-2E/ %x30-39/ %x41-5A
/ %x5E-7E
```

10.3.3.2 Negotiating RBVS Capabilities Between AS-SIP Videoconference EIs (RBVS-Compliant SIP Videoconference EIs) and AS-SIP Videoconference Servers

10.3.3.2.1 SDP Requirements for the Binary Floor Control Protocol (Based on RFC 4583)

SIP-006710 The “m” line for a BFCP stream MUST have a media field with the value “application,” a transport field with the value “UDP/BFCP,” and the ‘fmt’ field list MUST contain a single “*” character.

NOTE: The format list for BFCP is ignored.

Example of “m” line

m = application 50000 UDP/BFCP *

SIP-006720 AS-SIP videoconference EIs and RBVS-compliant SIP videoconference EIs MUST NOT attempt to create a TCP (or TCP/TLS) connection for transporting BFCP. This means AS-SIP videoconference EIs and RBVS-compliant SIP videoconference EIs MUST NOT use the “setup” or “connection” attributes with the establishment of a transport for BFCP messages.

SIP-006730 Videoconference servers MUST NOT attempt to create a TCP (or TCP/TLS) connection for transporting BFCP. This means Videoconference servers MUST NOT use the “setup” or “connection” attributes with the establishment of a transport for BFCP messages.

SIP-006740 If an AS-SIP videoconference EI or RBVS-compliant SIP videoconference EI or videoconference server receives an SDP offer in which the offeror attempts to establish a TCP/BFCP or TCP/TLS/BFCP connection, then the media stream for the BFCP channel MUST be rejected by setting the port value to zero in the SDP answer.

SIP-006750 AS-SIP videoconference EIs, RBVS-compliant SIP videoconference EIs, and videoconference servers MUST support the generation and the receipt and processing of the “floorid” SDP media-level attribute.

The Augmented Backus-Naur Form for the “floorid” attribute is as follows:

floor-id-attribute = "a=floorid:" token [" mstrm:" token *(SP token)]

NOTE: The “floorid” token is an integer value assigned to represent the floor (i.e., the shared resource) that will be managed using this BFCP channel. The token representing the media stream is a pointer to the media stream, which is identified by an SDP label attribute having the same value as that of the pointer.

SIP-006760 AS-SIP videoconference EIs, RBVS-compliant SIP videoconference EIs, and videoconference servers **MUST** support the generation and the receipt and processing of the “floorctrl” SDP media-level attribute.

The Augmented Backus-Naur Form for the “floorctrl” attribute is as follows:

```
floor-control-attribute = "a=floorctrl:" role *(SP role)
role                    = "c-only"/ "s-only"/ "c-s"
```

SIP-006770 AS-SIP videoconference EIs, RBVS-compliant SIP videoconference EIs, and videoconference servers **MUST** support the generation and the receipt and processing of the “confid” SDP media-level attribute.

The Augmented Backus-Naur Form for the “confid” attribute is as follows:

```
confid-attribute = "a=confid:" conference-id
conference-id = token
```

NOTE: An AS-SIP videoconference EI or RBVS-compliant SIP videoconference EI that generates an SDP offer **MUST NOT** generate the “confid” attribute.

NOTE: In a two-party videoconference the AS-SIP videoconference EI or RBVS-compliant SIP videoconference EI that generates the SDP answer **MUST** generate the “confid” attribute and **MUST** include the “confid” attribute in the SDP answer.

NOTE: A videoconference server **MUST** include the “confid” attribute when it generates an SDP offer. A videoconference server **MUST** include the “confid” attribute when it generates an SDP answer.

SIP-006780 AS-SIP videoconference EIs, RBVS-compliant SIP videoconference EIs, and videoconference servers **MUST** support the generation and the receipt and processing of the “userid” SDP media-level attribute.

The Augmented Backus-Naur Form for the “userid” attribute is as follows:

```
userid-attribute = "a=userid:" user-id
user-id = token
```

NOTE: An AS-SIP videoconference EI or RBVS-compliant SIP videoconference EI that generates an SDP offer **MUST NOT** generate the “userid” attribute.

NOTE: In a two-party videoconference the AS-SIP videoconference EI or RBVS-compliant SIP videoconference EI that generates the SDP answer **MUST** generate the “userid” attribute and **MUST** include the “userid” attribute in the SDP answer.

NOTE: A videoconference server MUST include the “userid” attribute when it generates an SDP offer. A videoconference server MUST include the “userid” attribute when it generates an SDP answer.

10.3.3.2.2 Securing the BFCP Control Channel

SIP-006790 The SIP Parity Activity Group of the International Multimedia Teleconferencing Consortium is currently in the process of defining the requirements for the use of Datagram Transport Layer Security for securing BFCP over UDP. The present intention is to adopt a stable version of this requirement for the UCR.

10.3.3.2.3 SDP Negotiation Requirements for Establishing a Video Session between a Videoconference EI and the Videoconference Server

SIP-006800 The SDP negotiation is performed in accordance with the following sequence of SDP offers and answers:

1. The AS-SIP videoconference EI (or RBVS-compliant SIP videoconference EI) sends INVITE with initial SDP offer to a videoconference server. The SDP offer has one ‘m=audio’ line, one ‘m=video’ line for the ‘main’ video stream, and one ‘m=application’ line for UDP/BFCP.

NOTE: A SIP videoconference EI that does not support BFCP (or a proprietary videoconference EI) will offer one ‘m=audio’ line, one ‘m=video’ line and will NOT offer the ‘m=application’ line for UDP/BFCP.

2. The videoconference server responds with a SDP answer in the 200 OK accepting the offer of one ‘m=audio’ line, one ‘m=video’ line for the ‘main’ video stream, and one ‘m=application’ line for UDP/BFCP.

NOTE: If the ‘m=application’ line for UDP/BFCP was not present in the SDP offer then the videoconference server will NOT add the ‘m=application’ line for UDP/BFCP to the SDP answer.

3. When an AS-SIP videoconference EI (or RBVS-compliant SIP videoconference EI) is ready to display content (e.g., a slide presentation) then it sends a re-INVITE with a SDP offer that adds a second “m=video” line for the “slides” video stream. Therefore, the SDP offer has an ‘m=audio’ line, an ‘m=video’ line for the ‘main’ video stream, an ‘m=application’ line for UDP/BFCP, and a second “m=video” line for the “slides” video stream.

NOTE: From the user interface perspective, when a user wishes to display content over the “slides” video stream the user launches an application intended to display video content⁹⁰, selects the content to be presented by the application over the “slides” video stream, and indicates to the application by means of a soft key or equivalent

⁹⁰ The user may already have the application open on the desktop from the start of the videoconference.

application-specific mechanism that the user wishes to transmit the content to the videoconference participants. This triggers the videoconference EI to send the re-INVITE to add the “slides” video stream and to exchange the appropriate BFCP messages (e.g., FloorRequest, FloorRequestStatus) with the videoconference server per draft-ietf-bfcpbis-rfc4582bis-05, “The Binary Floor Control Protocol (BFCP).”.

4. The videoconference server responds with a SDP answer accepting the offer of the ‘m=audio’ line, both ‘m=video’ lines, and the ‘m=application’ line for UDP/BFCP.
5. The videoconference Server sends a re-INVITE to each of the other participants in the videoconference whose original SDP negotiation included the ‘m=application’ line for UDP/BFCP. The re-INVITE includes a SDP offer that adds the “m=video” line for the “slides” video stream. The SDP offer has an ‘m=audio’ line, an ‘m=video’ line for the ‘main’ video stream, an ‘m=application’ line for UDP/BFCP, and a second “m=video” line for the “slides” video stream.

NOTE: If the ‘m=application’ line for UDP/BFCP was not present in the initial SDP negotiation between a videoconference EI and the video conference server then the videoconference server does NOT send a re-INVITE to the videoconference EI. Instead the videoconference server begins transmitting the content from the “slides” video stream to the videoconference EI on the existing video stream that had been displaying the ‘main’ video content.

6. Each participant receiving the re-INVITE responds with a 200 OK accepting the offer of one ‘m=audio’ line, a ‘m=video’ line (for ‘main’ content), a ‘m=application’ line for UDP/BFCP, and a second ‘m=video’ line (for “slides” content).

NOTE: AS-SIP videoconference EIs (or RBVS-compliant SIP videoconference EIs) that join the videoconference after the 2nd video stream has been established will conduct Step 1, followed by the videoconference server conducting Step 2 then the videoconference server will immediately proceed to Step 5 and the AS-SIP videoconference EI (or RBVS-compliant SIP videoconference EI) will respond with Step 6.

[Figure 10.3-1](#) depicts the call flow.

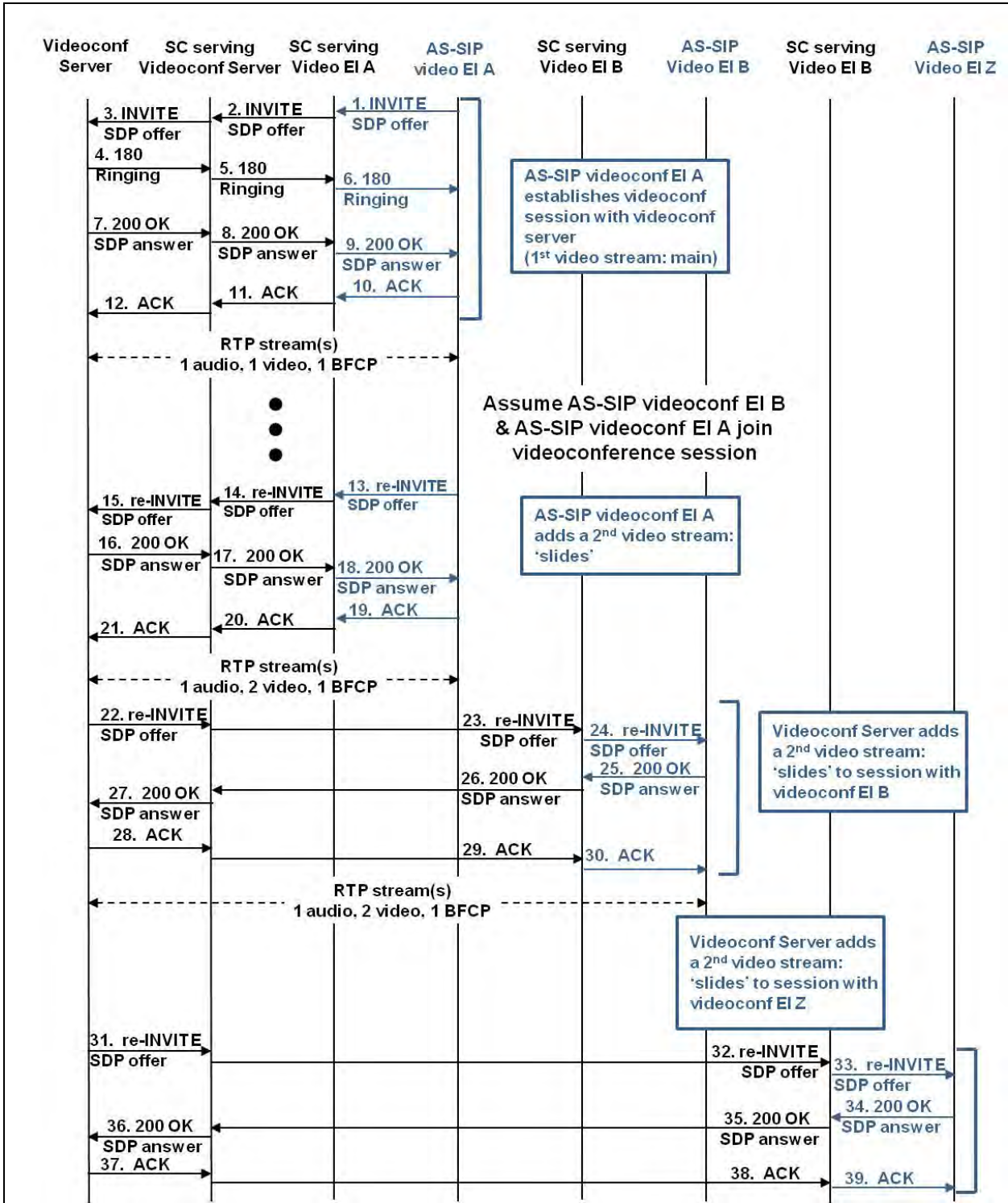

Figure 10.3-1. SDP Negotiation for Establishing Videoconference Between AS-SIP Videoconference EIs (or RBVS-Compliant SIP Videoconference EIs) and AS-SIP Videoconference Server

10.3.3.2.3.1 AS-SIP videoconference EI (or RBVS-Compliant SIP Videoconference EI)
Generates Initial SDP Offer

SIP-006810 When an AS-SIP videoconference EI (or RBVS-compliant SIP videoconference EI) initiates a videoconference then the SDP offer in the initial INVITE MUST contain one and only one “video” media line.

SIP-006820 The “video” media line MUST have an associated “content” attribute with the value “main.”

SIP-006830 The “video” media line MUST have an associated “label” attribute and the AS-SIP videoconference EI (or RBVS-compliant SIP videoconference EI) MUST assign an integer value to the “pointer” field.

SIP-006840 When an AS-SIP videoconference EI (or an RBVS-compliant SIP videoconference EI) initiates a videoconference then the SDP offer in the initial INVITE MUST contain a media line of type “application” for a BFCP stream whereby the transport protocol is UDP/BFCP and the format list has the value ‘*’.

SIP-006850 The “application” media line for BFCP MUST have an associated “floorid” attribute whereby a positive integer is assigned for the token representing the floor identifier and a label value is assigned for a video media stream to be established in a subsequent re-INVITE that will have a “content” attribute whose value is “slides.”

Example:

```
a=floorid:1 m-stream:10
```

where the value of the floor identifier in this example is “1” and the value of the label for the future video stream for “slides” is 10.

SIP-006860 The “application” media line for BFCP MUST have an associated “floorctrl” attribute. At a minimum, the AS-SIP videoconference EI (or RBVS-compliant SIP videoconference EI) MUST offer the value “c-only” for the “role” it is offering to perform. If the AS-SIP videoconference EI (or RBVS-compliant SIP videoconference EI) is capable of operating as a floor control server in addition to operating as a floor control client then the AS-SIP videoconference EI (or RBVS-compliant SIP videoconference EI) MUST offer the value “c-s” for the “role” it is offering to perform.

Example of SDP offer (media lines and associated attribute lines but crypto line not shown):

```
m=audio 49178 RTP/SAVP 0  
b=TIAS:64000  
m=video 49180 RTP/SAVP 109 31  
b=TIAS:320000
```



```
a=rtpmap:109 H264/90000
a=fmtp:109 profile-level-id=42800c;max-mbps=10000
a=rtpmap:31 H261/90000
a=fmtp:31 CIF=1;QCIF=1
```

```
a=content:main
a=label:11
m=application 24000 UDP/BFCP *
a=floorid:1 m-stream=10
a=floorctrl:c-s
```

10.3.3.2.3.2 AS-SIP Videoconference Server Generates Initial SDP Answer

SIP-006870 When the videoconference server generates the SDP answer to the initial SDP offer then (assuming at least 1 supported video codec was present in the offered “m=video” media line) the videoconference server accepts the m=video media line.

SIP-006880 The “video” media line MUST have an associated “content” attribute with the value “main.”

SIP-006890 The “video” media line MUST have an associated “label” attribute and the videoconference server MUST assign an integer value to the “pointer” field.

SIP-006900 The videoconference server MUST accept the “m=application” media line for BFCP where the “transport” field is UDP/BFCP and the “fmt” field list MUST contain a single “*” character.

NOTE: We have already specified in requirement SIP-006710 that the “transport” field in the “application” media line in the SDP offer MUST have the value UDP/BFCP and the fmt list MUST contain a single “*” character.

SIP-006910 The “application” media line for BFCP MUST have an associated “floorid” attribute whereby a positive integer is assigned for the token representing the floor identifier and a label value is assigned for a video media stream to be established in a subsequent re-INVITE that will have a “content” attribute whose value is “slides.”

Example:

```
a=floorid:1 m-stream:12
```

where the value of the floor identifier in this example is “1” and the value of the label for the future video stream for “slides” is “12.”

SIP-006920 The “application” media line for BFCP MUST have an associated “floorctrl” attribute whose role is set to “s-only.”

SIP-006930 The “application” media line for BFCP MUST have an associated “confid” attribute set to an integer value (i.e., a unique conference ID) assigned by the videoconference server.

SIP-006940 The “application” media line for BFCP MUST have an associated ‘userid’ attribute set to an integer value (i.e., a unique user ID for the dialog with this particular AS-SIP videoconference EI or RBVS-compliant SIP videoconference EI) assigned by the videoconference server.

Example of SDP answer (media lines and associated attribute lines but crypto line not shown):

```
m=audio 42000 RTP/SAVP 0
b=TIAS:64000
m=video 42200 RTP/SAVP 109
b=TIAS:320000
a=rtpmap:109 H264/90000
a=fmtp:109 profile-level-id=42800c;max-mbps=10000

a=label:13
m=application 30004 UDP/BFCP *
a=floorid:1 m-stream=12
a=confid: 2222
a=userid:3333

a=floorctrl:s-only
```

10.3.3.2.3.3 AS-SIP videoconference EI (or RBVS-compliant SIP videoconference EI) Sends SDP Offer including 2nd “Video” Media Stream

SIP-006950 When a participant to the videoconference wishes to display content over the “slides” video stream the user launches an application intended to display video content⁹¹, selects the content to be presented by the application over the “slides” video stream, and indicates to the application by means of a soft key or equivalent application-specific mechanism that the user wishes to transmit the content to the videoconference participants. This triggers the AS-SIP videoconference EI (or RBVS-compliant SIP videoconference EI) to send a re-INVITE with a SDP offer that adds a second “video” media line and initiates the exchange of the appropriate BFCP messages (e.g., FloorRequest, FloorRequestStatus) with the videoconference server per draft-ietf-bfcpbis-rfc4582bis-05, “The Binary Floor Control Protocol (BFCP)”.

SIP-006960 The second “video” media line MUST have an associated “content” attribute with the value “slides.”

⁹¹ The user may already have the application open on the desktop from the start of the videoconference.

SIP-006970 The second “video” media line **MUST** have an associated “label” attribute whose pointer has the same value as that assigned to the ‘m-stream’ field of the ‘floorid’ attribute associated with the BFCP media description from the SDP offer in the initial INVITE.

Example of SDP offer including 2nd “video” media line (media lines and associated attribute lines but crypto line not shown):

```
m=audio 49178 RTP/SAVP 0
b=TIAS:64000
m=video 49180 RTP/SAVP 109 31
b=TIAS:320000
a=rtpmap:109 H264/90000
a=fmtp:109 profile-level-id=42800c;max-mbps=10000
a=rtpmap:31 H261/90000
a=fmtp:31 CIF=1;QCIF=1

        a=content:main
        a=label:11
        m=application 24000 UDP/BFCP *
        a=floorid:1 m-stream=10
        a=floorctrl:c-s
        m=video 34320 RTP/SAVP 41

a=rtpmap:41 H261/90000
a=fmtp:41 CIF=1;QCIF=1
a=content:slides
a=label:10
```

NOTE: The value assigned to “m-stream” is 10 therefore the “label” attribute for the “slides” video stream **MUST** be 10.

SIP-006980 Videoconference Server Responds with SDP Answer Accepting Second “Video” Media Stream.

SIP-006980.a When the videoconference server receives the SDP offer with the second “video” media line then the videoconference server responds with a SDP answer that accepts the second ‘m=video’ media line (in addition to the ‘m=audio’ line, the 1st ‘m=video’ media line and the ‘application’ media line for BFCP).

SIP-006980.b The second “video” media line **MUST** have an associated “content” attribute with the value “slides.”

SIP-006980.c The second “video” media line **MUST** have an associated “label” attribute whose pointer has the same value as that assigned to the ‘m-stream’ field of the ‘floorid’ attribute associated with the BFCP media description from the SDP answer in the initial INVITE.

Example of SDP answer including second “video” media line (media lines and associated attribute lines but crypto line not shown):

```
m=audio 42000 RTP/SAVP 0
b=TIAS:64000
m=video 42200 RTP/SAVP 109
b=TIAS:320000
a=rtpmap:109 H264/90000
a=fmtp:109 profile-level-id=42800c;max-mps=10000

a=label:13
m=application 30004 UDP/BFCP *
a=floorid:1 m-stream=12
a=confid: 2222
a=userid:3333

a=floorctrl:s-only

m=video 24542 RTP/SAVP 41
a=rtpmap:41 H261/90000
a=fmtp:41 CIF=1;QCIF=1
a=content:slides
a=label:12
```

NOTE: The value assigned to “m-stream” is 12 therefore the “label” attribute for the “slides” video stream MUST be 12.

SIP-006990 Videoconference Server Sends SDP Offer including 2nd “Video” Media Stream to the Other Participants.

SIP-006990.a Upon establishment of the second video media stream between a first videoconference EI and the videoconference server, the videoconference server MUST establish a 2nd video stream with each of the other participants to the videoconference whose initial SDP negotiation included an “m=application” media description for BFCP. The videoconference server MUST send a re-INVITE with a SDP offer that adds a second “video” media line to each of the AS-SIP videoconference EIs (and RBVS-compliant SIP videoconference EIs) that are participants to the videoconference session (excluding the participant that has already established the 2nd video stream with the videoconference server).

SIP-006990.b The second “video” media line MUST have an associated “content” attribute with the value “slides.”

SIP-006990.c The second “video” media line MUST have an associated “label” attribute whose pointer has the same value as that assigned to the “m-stream” field of the “floorid”

attribute associated with the BFCP media description from the SDP answer to the initial INVITE.

SIP-007000 All Other Participants Respond with SDP Answer Accepting 2nd “Video” Media Stream.

SIP-007000.a When an AS-SIP videoconference EI (or RBVS-compliant SIP videoconference EI) receives the SDP offer with the second “video” media line then it MUST generate a SDP answer that accepts the second “m=video” media line (as well as the “m=audio” line, 1st “m=video” media line and the “m=application” media line for BFCP).

SIP-007000.b The second “video” media line MUST have an associated “content” attribute with the value “slides.”

SIP-007000.c The second “video” media line MUST have an associated “label” attribute whose pointer has the same value as that assigned to the “m-stream” field of the “floorid” attribute associated with the BFCP media description from the SDP offer in the initial INVITE.

10.3.3.3 Managing Control of “slides” Video Stream Using BFCP

SIP-007010 AS-SIP videoconference EIs (and RBVS-compliant SIP videoconference EIs) MUST implement a keep-alive mechanism for the BFCP control channel whereby the AS-SIP videoconference EIs (and RBVS-compliant SIP videoconference EIs) MUST send a BFCP “Hello” message to the videoconference server approximately once every 30 seconds and the videoconference server MUST respond with a BFCP “HelloAck message.”

SIP-007020 After the “slides” video stream is established between an AS-SIP videoconference EI (or RBVS-compliant SIP videoconference EI) and the videoconference server then whenever the AS-SIP videoconference EI (or RBVS-compliant SIP videoconference EI) does not have the floor for the “slides” video stream then the AS-SIP videoconference EI (or RBVS-compliant SIP videoconference EI) MUST implement a keep-alive mechanism whereby it sends RTP and RTCP packets to the videoconference server approximately once every 30 seconds with a payload type supported by the “slides” video stream but with a zero-length payload. The AS-SIP videoconference EI (or RBVS-compliant SIP videoconference EI) does not employ this keep-alive mechanism whenever it has the floor for the “slides” video stream (i.e., whenever it temporarily controls the “slides” video stream for purpose of sending content to the videoconference server for forwarding to the other participants).

SIP-007030 AS-SIP videoconference EIs (RBVS-compliant videoconference EIs) and videoconference servers MUST comply with draft-ietf-bfcpbis-rfc4582bis-05, “The Binary Floor Control Protocol (BFCP)” in order to adapt BFCP for use over an unreliable transport (e.g., UDP).

SIP-007040 Each BFCP UDP datagram MUST contain only one BFCP message. (draft-ietf-bfcpbis-rfc4582bis-05, “The Binary Floor Control Protocol (BFCP)” sec. 6.2).

SIP-007050 AS-SIP videoconference EIs and RBVS-compliant videoconference EIs MUST comply with all BFCP client requirements set forth in draft-ietf-bfcpbis-rfc4582bis-05, “The Binary Floor Control Protocol (BFCP).

SIP-007060 AS-SIP videoconference EIs and RBVS-compliant videoconference EIs designed to be capable of operating as a BFCP server in a 2-party point-to-point videoconference MUST comply with all BFCP server requirements set forth in draft-ietf-bfcpbis-rfc4582bis-05, “The Binary Floor Control Protocol (BFCP)”.

SIP-007070 Videoconference servers MUST comply with all BFCP server requirements set forth in draft-ietf-bfcpbis-rfc4582bis-05, “The Binary Floor Control Protocol (BFCP)”.

SIP-007080 Videoconference EIs (RBVS-compliant videoconference EIs) and videoconference servers MUST support the generation and receipt/processing of the BFCP Common Header (draft-ietf-bfcpbis-rfc4582bis-05, sec. 5.1).

SIP-007090 AS-SIP videoconference EIs (RBVS-compliant videoconference EIs) and videoconference servers MUST implement the Request Retransmission Timer, T1 and the Response Retransmission Timer, T2 as set forth in draft-ietf-bfcpbis-rfc4582bis-05 sec 8.3, 8.3.1, 8.3.2, and 8.3.3. Per draft-ietf-bfcpbis-rfc4582bis-05 sec 8.3.3 the default value for T1 is 500ms and the default value for T2 is 10 seconds.

SIP-007100 AS-SIP videoconference EIs and RBVS-compliant videoconference EIs MUST support generating the following BFCP message primitives in accordance with draft-ietf-bfcpbis-rfc4582bis-05:

- FloorRequest.....(draft-ietf-bfcpbis-rfc4582bis-05 sec. 5.3.1)
- FloorRelease(draft-ietf-bfcpbis-rfc4582bis-05 sec. 5.3.2)
- FloorRequestQuery.....(draft-ietf-bfcpbis-rfc4582bis-05 sec. 5.3.3)
- UserQuery.....(draft-ietf-bfcpbis-rfc4582bis-05 sec. 5.3.5)
- FloorQuery.....(draft-ietf-bfcpbis-rfc4582bis-05 sec. 5.3.7)
- ChairAction.....(draft-ietf-bfcpbis-rfc4582bis-05 sec. 5.3.9)
- Hello.....(draft-ietf-bfcpbis-rfc4582bis-05 sec. 5.3.11)
- FloorRequestStatusAck.....(draft-ietf-bfcpbis-rfc4582bis-05 sec. 5.3.14)
- FloorStatusAck(draft-ietf-bfcpbis-rfc4582bis-05 sec. 5.3.15)
- Goodbye.....(draft-ietf-bfcpbis-rfc4582bis-05 sec. 5.3.16)
- GoodbyeAck(draft-ietf-bfcpbis-rfc4582bis-05sec. 5.3.17)

SIP-007110 Videoconference servers [and AS-SIP videoconference EIs and RBVS-compliant videoconference EIs operating as BFCP servers in a 2-party point-to-point videoconference] MUST support receiving/processing the BFCP message primitives of requirement SIP-007100.

SIP-007120 Videoconference servers [and AS-SIP videoconference EIs and RBVS-compliant videoconference EIs designed to be capable of operating as a BFCP server in a 2-party point-to-point videoconference] MUST support generating the following BFCP message primitives in accordance with draft-ietf-bfcpbis-rfc4582bis-05:

- FloorRequestStatus(draft-ietf-bfcpbis-rfc4582bis-05 sec. 5.3.4)
- UserStatus(draft-ietf-bfcpbis-rfc4582bis-05 sec. 5.3.6)
- FloorStatus(draft-ietf-bfcpbis-rfc4582bis-05 sec. 5.3.8)
- ChairActionAck(draft-ietf-bfcpbis-rfc4582bis-05 sec. 5.3.10)
- HelloAck(draft-ietf-bfcpbis-rfc4582bis-05 sec. 5.3.12)
- Error(draft-ietf-bfcpbis-rfc4582bis-05 sec. 5.3.13)
- Goodbye(draft-ietf-bfcpbis-rfc4582bis-05 sec. 5.3.16)
- GoodbyeAck(draft-ietf-bfcpbis-rfc4582bis-05sec. 5.3.17)

SIP-007130 AS-SIP videoconference EIs and RBVS-compliant videoconference EIs MUST support receiving/processing the BFCP message primitives of requirement SIP-007120.

SIP-007140 AS-SIP videoconference EIs and RBVS-compliant videoconference EIs MUST support generating the following BFCP attributes in accordance with draft-ietf-bfcpbis-rfc4582bis-05:

- BENEFICIARY-ID(draft-ietf-bfcpbis-rfc4582bis-05 sec. 5.2.1)
- FLOOR-ID(draft-ietf-bfcpbis-rfc4582bis-05 sec. 5.2.2)
- FLOOR-REQUEST-ID(draft-ietf-bfcpbis-rfc4582bis-05 sec. 5.2.3)
- PRIORITY(draft-ietf-bfcpbis-rfc4582bis-05 sec. 5.2.4)
- REQUEST-STATUS(Chair only) (draft-ietf-bfcpbis-rfc4582bis-05 sec. 5.2.5)
- PARTICIPANT-PROVIDED-INFO(draft-ietf-bfcpbis-rfc4582bis-05 sec. 5.2.8)
- STATUS-INFO(Chair only) (draft-ietf-bfcpbis-rfc4582bis-05 sec. 5.2.9)
- USER-DISPLAY-NAME(Chair only) (draft-ietf-bfcpbis-rfc4582bis-05 sec. 5.2.12)
- USER-URI(Chair only) (draft-ietf-bfcpbis-rfc4582bis-05 sec. 5.2.13)
- BENEFICIARY-INFORMATION. (Chair only) (draft-ietf-bfcpbis-rfc4582bis-05 sec. 5.2.14)
- FLOOR-REQUEST-INFORMATION(Chair only) (draft-ietf-bfcpbis-rfc4582bis-05 sec. 5.2.15)
- REQUESTED-BY-INFORMATION(Chair only) (draft-ietf-bfcpbis-rfc4582bis-05 sec. 5.2.16)

- FLOOR-REQUEST-STATUS.....(Chair only) (draft-ietf-bfcpbis-rfc4582bis-05 sec. 5.2.17)
- OVERALL-REQUEST-STATUS ..(Chair only) (draft-ietf-bfcpbis-rfc4582bis-05 sec. 5.2.18)

SIP-007150 Videoconference servers [and AS-SIP videoconference EIs and RBVS-compliant videoconference EIs operating as BFCP servers in a 2-party point-to-point videoconference] MUST support receiving/processing the BFCP attributes of requirement SIP-007140.

SIP-007160 Videoconference servers (and AS-SIP videoconference EIs and RBVS-compliant videoconference EIs designed to be capable of operating as a BFCP server in a 2-party point-to-point videoconference) MUST support generating the following BFCP attributes in accordance with draft-ietf-bfcpbis-rfc4582bis-05:

- FLOOR-ID(draft-ietf-bfcpbis-rfc4582bis-05 sec. 5.2.2)
- PRIORITY(draft-ietf-bfcpbis-rfc4582bis-05 sec. 5.2.4)
- REQUEST-STATUS(draft-ietf-bfcpbis-rfc4582bis-05 sec. 5.2.5)
- ERROR-CODE(draft-ietf-bfcpbis-rfc4582bis-05 sec. 5.2.6)

NOTE: draft-ietf-bfcpbis-rfc4582bis-05 adds 5 new error codes not present in RFC 4582: 10 Unable to parse message, 11 Use DTLS, 12 Unsupported version, 13 Incorrect message length, 14 Generic error.

- ERROR-INFO.....(draft-ietf-bfcpbis-rfc4582bis-05 sec. 5.2.7)
- PARTICIPANT-PROVIDED-INFO(draft-ietf-bfcpbis-rfc4582bis-05 sec. 5.2.8)
- STATUS-INFO.....(draft-ietf-bfcpbis-rfc4582bis-05 sec. 5.2.9)
- SUPPORTED-ATTRIBUTES.....(draft-ietf-bfcpbis-rfc4582bis-05 sec. 5.2.10)
- SUPPORTED-PRIMITIVES.....(draft-ietf-bfcpbis-rfc4582bis-05 sec. 5.2.11)
- USER-DISPLAY-NAME.....(draft-ietf-bfcpbis-rfc4582bis-05 sec. 5.2.12)
- USER-URI(draft-ietf-bfcpbis-rfc4582bis-05 sec. 5.2.13)
- BENEFICIARY-INFORMATION.....(draft-ietf-bfcpbis-rfc4582bis-05 sec. 5.2.14)
- FLOOR-REQUEST-INFORMATION.....(draft-ietf-bfcpbis-rfc4582bis-05 sec. 5.2.15)
- REQUESTED-BY-INFORMATION(draft-ietf-bfcpbis-rfc4582bis-05 sec. 5.2.16)
- FLOOR-REQUEST-STATUS.....(draft-ietf-bfcpbis-rfc4582bis-05 sec. 5.2.17)
- OVERALL-REQUEST-STATUS(draft-ietf-bfcpbis-rfc4582bis-05 sec. 5.2.18)

SIP-007170 AS-SIP videoconference EIs and RBVS-compliant videoconference EIs operating as BFCP clients MUST support receiving/processing the BFCP attributes of requirement SIP-007160.

SIP-007180 BFCP clients **MUST** send a Hello message to announce their presence to the floor control server (draft-ietf-bfcpbis-rfc4582bis-05 sec. 6.2).

SIP-007190 The floor control server **MUST** respond to the Hello with a HelloAck message. (draft-ietf-bfcpbis-rfc4582bis-05 sec. 6.2).

NOTE: The BFCP client considers the BFCP channel with the floor control server to be present and operational upon receipt of the HelloAck message from the floor control server.

SIP-007200 Each BFCP request sent by a client (participant or chair) to the floor control server constitutes a client transaction and the floor control server **MUST** respond with an appropriate acknowledgement message within the retransmission window (draft-ietf-bfcpbis-rfc4582bis-05 sec. 6.2).

SIP-007210 Whenever the floor control server sends a message that is not completing a transaction, known as server-initiated transactions, then the BFCP client **MUST** respond with an appropriate acknowledgement message within the retransmission window.

SIP-007220 A BFCP client-server pair **MUST** have no more than 1 pending transaction at any given time. The BFCP message that would start another client-initiated transaction or server-initiated transaction can only be transmitted after receipt of an acknowledgement to the pending transaction.

SIP-007230 If a BFCP client or server receives an ICMP port unreachable message, it **MUST** consider the channel closed (as if it had received a Goodbye message). The recipient of the ICMP port unreachable message **MAY** send a re-INVITE with a different transaction ID to attempt to re-establish the BFCP channel.

SIP-007240 AS-SIP videoconference EIs (and RBVS-compliant videoconference EIs) that are operating either as floor participants or floor chairs **MUST** support the following operations:

- Request information about floors by generating and sending a FloorQuery message to the floor control server and receiving/processing the FloorStatus responses. In the case of all FloorStatus responses beyond the first FloorStatus response, the participant EI **MUST** respond with a FloorStatusAck message within the transaction failure window to complete the transaction (draft-ietf-bfcpbis-rfc4582bis-05, sections 12.1, 12.1.1, 12.1.2, and 12.1.3).
- Request information about the status of the floor request by generating and sending a FloorRequestQuery message to the floor control server and receiving and processing the FloorRequestStatus responses. In the case of all FloorRequestStatus responses beyond the first FloorRequestStatus response, the participant EI **MUST** respond with a FloorRequestStatusAck message within the transaction failure window to complete the transaction (draft-ietf-bfcpbis-rfc4582bis-05, sections 10.1.3, 12.2, 12.2.1, 12.2.2).

- Request information about a user by generating/sending a UserQuery message to the floor control server and receiving/processing the UserStatus response (draft-ietf-bfcpbis-rfc4582bis-05, sections 12.3, 12.3.1, 12.3.2).
- Obtain information on the capabilities of the floor control server by generating/sending a Hello message to the floor control server and receiving/processing the HelloAck response (draft-ietf-bfcpbis-rfc4582bis-05, sections 12.4, 12.4.1, 12.4.2).

SIP-007250 The Floor Control Server MUST support receipt and processing of the FloorQuery message and the generating and sending of a first FloorStatus message within the transaction failure window. The floor control server MUST periodically generate and send subsequent FloorStatus messages (draft-ietf-bfcpbis-rfc4582bis-05 sections 13.5, 13.5.1, 13.5.2).

SIP-007260 The Floor Control Server MUST support receipt/processing of the FloorRequestQuery message and the generating/sending of a first FloorRequestStatus message within the transaction failure window. The floor control server MUST periodically generate and send subsequent FloorRequestStatus messages (draft-ietf-bfcpbis-rfc4582bis-05 section 13.2).

SIP-007270 The Floor Control Server MUST support receipt/processing of the UserQuery message and the generating/sending of the UserStatus message within the transaction failure window. (draft-ietf-bfcpbis-rfc4582bis-05 sections 13.3).

SIP-007280 The Floor Control Server MUST support receipt/processing of the Hello message and generating/sending of the HelloAck message within the transaction failure window. (draft-ietf-bfcpbis-rfc4582bis-05 section 13.7).

SIP-007290 AS-SIP videoconference EIs (and RBVS-compliant videoconference EIs) that are operating as floor participants (NOT floor chairs) MUST support the following operations:

- Request a floor by generating and sending a FloorRequest message to the floor control server and receiving and processing the FloorRequestStatus responses. In the case of all FloorRequestStatus responses beyond the first FloorRequestStatus response, the participant EI MUST respond with a FloorStatusAck message within the transaction failure window to complete the transaction (draft-ietf-bfcpbis-rfc4582bis-05 sec10.1, 10.1.1, 10.1.2, and 10.1.3).
- Cancel a floor request or release a floor by generating/sending a FloorRelease message to the floor control server and receiving/processing the FloorRequestStatus message. (Floor Request Status sections. 10.2, 10.2.1, 10.2.2).

SIP-007300 The Floor Control Server MUST support receipt/processing of the FloorRequest message and the generating/sending of a first FloorRequestStatus message within the transaction failure window. The floor control server MUST periodically generate and send subsequent FloorRequestStatus messages (draft-ietf-bfcpbis-rfc4582bis-05 sec. 13.1, 13.1.1, and 13.1.2).

SIP-007310 The Floor Control Server MUST support receipt/processing the FloorRelease message and generating/sending the FloorRequestStatus message within the transaction failure window. (draft-ietf-bfcpbis-rfc4582bis-05 sec. 13.4).

SIP-007320 AS-SIP videoconference EIs (and RBVS-compliant videoconference EIs) that are operating as floor chairs (NOT floor participants) MUST support the following operation:

- Instruct the floor control server to grant or revoke a floor by generating and sending a ChairAction message to the floor control server and receiving and processing the ChairActionAck response. (draft-ietf-bfcpbis-rfc4582bis-05 sec. 11.1, 11.2).

SIP-007330 The Floor Control Server MUST support receipt/processing the ChairAction message and generating/sending the ChairActionAck message within the transaction failure window. (draft-ietf-bfcpbis-rfc4582bis-05 Sec. 13.6).

SIP-007340 The Floor Control Server MUST generate and send an Error message in response to a client request message in the event any of the 14 error conditions set forth in draft-ietf-bfcpbis-rfc4582bis-05 is encountered. The Error message MUST be sent within the transaction failure window. The BFCP client MUST respond with an ErrorAck message within the transaction failure window. (draft-ietf-bfcpbis-rfc4582bis-05 Sec. 5.2.6, and 13.8).

NOTE: The error conditions are as follows:

1. Conference Does Not Exist.
2. User Does Not Exist.
3. Unknown Primitive.
4. Unknown Mandatory Attribute.
5. Unauthorized Operation.
6. Invalid Floor ID.
7. Floor Request ID Does Not Exist.
8. You have Already Reached the Maximum Number of Ongoing Floor Requests for this Floor.
9. Use TLS (Not applicable).
10. Unable to Parse Message.
11. Use DTLS.
12. Unsupported Version.
13. Incorrect Message Length.
14. Generic Error.

SIP-007350 A client that wishes to end its BFCP association with a floor control server, **MUST** send a Goodbye message. The floor control server **MUST** respond with GoodbyeAck.

SIP-007360 A floor control server that wishes to end its BFCP association with a client **MUST** send a Goodbye message. The client **MUST** respond with GoodbyeAck.

10.3.4 Video Channel Flow Control

SIP-007370 Videoconference servers **MUST** be implemented as mixers in accordance with RFC 3550 Section 7.1 whereby all data packets forwarded by videoconference servers **MUST** be marked with the videoconference server's own SSRC identifier.

- The SSRC identifier(s) of the original source(s) contributing to the mixed packet **MUST** be placed in the CSRC list for the data packet.

SIP-007380 RFC 4585 is the method adopted by this UCR for implementing video channel flow control. RFC 4585 is an extension of the audio-visual profile detailed in RFC 3550 that specifies mechanisms for receivers to provide new low-delay RTCP feedback messages to senders to more rapidly and more effectively provide feedback information on the quality of the received media streams. This timely feedback enables senders to conduct short-term adaptation and repair of the media streams associated with video conferencing.

SIP-007390 AS-SIP videoconference EIs and videoconference servers **MUST** support video channel flow control, and therefore, **MUST** comply with RFC 4585.

NOTE: Non-AS-SIP IP videoconference EIs within an SC SUT that comply with RFC 4585 as specified in this section shall also be capable of exchanging RTCP feedback messages with AS-SIP videoconference EIs and videoconference servers.

SIP-007390.a AS-SIP videoconference EIs and videoconference servers **MUST** implement the requirements set forth in RFC 4585. In particular, AS-SIP videoconference EIs and videoconference servers **MUST** implement the following sections of RFC 4585:

- Section 3.1, Compound RTCP Feedback Packets.
- Section 3.2, Algorithm Outline.
- Section 3.3, Modes of Operation.
- Section 3.4, Definitions and Algorithm Overview.
- Section 3.5, AVPF RTCP Scheduling Algorithm:
 - All subsections 3.5.1–3.5.4, inclusive.
- Section 3.6.1, ACK Mode.
- Section 3.6.2, NACK Mode.

- Section 4.1, Profile Identification.
- Section 4.2, RTCP Feedback Capability Attribute.
- Section 4.3, RTCP Bandwidth Modifiers.
- Section 5, Interworking and Coexistence of AVP and Audio-Visual Profile With Feedback (AVPF) Entities.
- Section 6, Format of RTCP Feedback Messages.
- Section 6.1, Common Packet Format for Feedback Messages.
- Section 6.2, Transport Layer Feedback Messages, including the following:
 - 6.2.1, Generic NACK.
- Section 6.3, Payload-Specific Feedback Messages, including the following:
 - 6.3.1, Picture Loss Indication (PLI) and its subsections.
 - 6.3.2, Slice Loss Indication (SLI) and its subsections.
 - 6.3.3, Reference Picture Selection Indication (RPSI) and its subsections.
- Section 6.4, Application Layer Feedback Messages.

SIP-007400 AS-SIP videoconference EIs and videoconference servers **MUST** support the generation and receipt/processing of the sdp attribute “a=rtcp-fb” where the “rtcp-fb” attribute **MUST** only be used as an sdp media-level attribute and never as a session-level attribute.

The Augmented Backus-Naur Form for the “rtcp-fb” attribute is as follows:

```
rtcp-fb-syntax = "a=rtcp-fb:" rtcp-fb-pt SP rtcp-fb-val CRLF
rtcp-fb-pt = "*" ; wildcard: applies to all formats
/ fmt ; as defined in SDP spec
rtcp-fb-val = "ack" rtcp-fb-ack-param
/ "nack" rtcp-fb-nack-param
/ "trr-int" SP 1*DIGIT
/ rtcp-fb-id rtcp-fb-param
rtcp-fb-id = 1*(alpha-numeric/ "-"/ "_")
rtcp-fb-param = SP "app" [SP byte-string]
/ SP token [SP byte-string]
/ ; empty
rtcp-fb-ack-param = SP "rpsi"
/ SP "app" [SP byte-string]
/ SP token [SP byte-string]
/ ; empty
rtcp-fb-nack-param = SP "pli"
/ SP "sli"
/ SP "rpsi"
/ SP "app" [SP byte-string]
```

/ SP token [SP byte-string]
/ ; empty

NOTE: The feedback type “ack” MAY only be used in two-party sessions and MAY be used either with or without the “rpsi” parameter.

NOTE: The feedback type “nack” without parameters indicates the use of the generic “nack” feedback format. The feedback type “nack” with parameters “pli,” “sli,” or “rpsi” indicates support for the specified payload-specific feedback messages where:

“pli” indicates the Picture Loss Indication feedback message.

“sli” indicates the Slice Loss Indication feedback message.

“rpsi” indicates the Reference Picture Selection Indication feedback message.

NOTE: The feedback type “tr-int” specifies the minimum interval, T_{rr} interval, between two regular (full compound) RTCP packets in milliseconds for this media session. If “tr-int” is not specified, a default value of zero is assumed.

SIP-007410 The wildcard payload type (“*”) MAY be used to indicate that the RTCP feedback attribute applies to all payload types.

Example:

```
m=video 51372 RTP/AVPF 98 99
c=IN IP4 224.2.1.184
a=rtpmap:98 H263-1998/90000
a=rtpmap:99 H261/90000
a=rtcp-fb:* nack
```

In this case, the wildcard “*” indicates that the sender supports a generic “nack” for both H.263-1998 and for H.261.

SIP-007420 In the event that several types of feedback are supported and/or the sender wishes to offer the same feedback for a subset of the payload types, then several “a=rtcp fb” lines MUST be used.

Example of 2 types of feedback:

```
m=video 51372 RTP/AVPF 98 99
c=IN IP4 224.2.1.184
a=rtpmap:98 H263-1998/90000
a=rtpmap:99 H261/90000
a=rtcp-fb:* nack
a=rtcp-fb:98 nack rpsi
```

The sender supports generic “nack” feedback for H.263-1998 and for H.261; the sender supports Reference Picture Selection Indication feedback for H.263-1998.

SIP-007430 When an AS-SIP videoconference EI or videoconference server receives an sdp offer having “rtcp fb” attributes, then the AS-SIP videoconference EI or videoconference server MUST ignore any “rtcp fb” attribute if any of the values for a given “rtcp-fb” attribute line is not understood. In other words, the entire attribute line “a=rtcp-fb” MUST be ignored if any value in the line is not understood.

SIP-007440 When an AS-SIP videoconference EI or videoconference server receives an sdp offer having “rtcp fb” attributes, then the AS-SIP videoconference EI or videoconference server MUST remove all attribute lines it does not understand as well as those it does not support in general or does not wish to use in this particular media session when generating the sdp answer.

SIP-007450 When an AS-SIP videoconference EI or videoconference server receives an sdp offer, then the AS-SIP videoconference EI or videoconference server MUST NOT add feedback parameters to the media description and MUST NOT alter the values of the feedback parameters.

SIP-007460 The offeror and answerer MUST only use the feedback mechanisms negotiated in the sdp offer/answer exchange.

SIP-007470 The AS-SIP videoconference EIs and videoconference servers MUST silently discard all RTCP feedback messages that they do not understand.

10.3.5 Video Channel Fast Update Requests

SIP-007480 The Full Intra Request (FIR) payload-specific feedback message specified in RFC 5104 Codec Control Messages in the RTP Audio-Visual Profile with Feedback (AVPF) is the method adopted by this UCR for implementing video channel fast update requests.

NOTE: A video channel fast update request is sent by a receiver of a video stream (that needs to resynchronize the stream) to the sender of the given video stream and constitutes a request to the sender to send a full frame or intra frame at the earliest opportunity. (Intra pictures in the case of H.261, H.263; Instantaneous Decoder Refresh (IDR) pictures in the case of H.264).

SIP-007490 AS-SIP videoconference EIs and videoconference servers MUST support the generation and receipt/processing of FIR feedback messages per RFC 5104.

NOTE: Non-AS-SIP IP videoconference EIs within an SC SUT that comply with RFC 5104 as specified in this section shall be capable of exchanging FIR feedback messages with AS-SIP videoconference EIs and videoconference servers.

SIP-007500 AS-SIP videoconference EIs and videoconference servers MUST comply with the requirements set forth in RFC 5104, Section 3.5.1, Full Intra Request Command, Section 3.5.1.1, Reliability, Section 4.3, Payload-Specific Feedback Messages, Section 4.3.1, Full Intra Request

(FIR), and its subsections 4.3.1.1 to 4.3.1.5 inclusive, Section 7.1, Extension of the rtcp-fb Attribute, and Section 7.2, Offer-Answer.

SIP-007500.a AS-SIP videoconference EIs and videoconference servers MUST support the new feedback type “ccm” (i.e., codec control message) and the associated parameter “rtcp-fb-ccm-param” having the value “fir.”

The Augmented Backus-Naur Form for rtcp-fb-val (which is defined in RFC 4585 and copied in SIP-007400) is extended to support FIR commands as follows:

```
rtcp-fb-val    =/ "ccm" rtcp-fb-ccm-param.  
rtcp-fb-ccm-param  = SP "fir" ; Full Intra Request.
```

SIP-007510 When an AS-SIP videoconference EI or videoconference server wishes to employ fast update requests for one or more video streams, the AS-SIP videoconference EI or videoconference server MUST generate an sdp offer with the “rtcp-fb” attribute with feedback type “ccm” and rtcp-fb-ccm-param with value “fir” associated with said video stream(s).

SIP-007520 When an AS-SIP videoconference EI or videoconference server receives an sdp offer with the “rtcp-fb” attribute with feedback type “ccm” and rtcp-fb-ccm-param with value “fir” associated with one or more video streams and the AS-SIP videoconference EI or videoconference server wishes to generate and receive/process the FIR payload-specific feedback message then the AS-SIP videoconference EI or videoconference server MUST respond by including the identical “rtcp-fb” attribute in the sdp answer.

Example offer:

```
v=0  
o=alice 3203093520 3203093520 IN IP4 host.example.com  
s=Offer/Answer  
c=IN IP4 192.0.2.124  
m=audio 49170 RTP/AVP 0  
a=rtpmap:0 PCMU/8000  
m=video 51372 RTP/AVPF 98  
a=rtpmap:98 H263-1998/90000  
a=rtcp-fb:98 ccm fir
```

Example answer:

```
v=0  
o=alice 3203093520 3203093524 IN IP4 otherhost.example.com  
s=Offer/Answer  
c=IN IP4 192.0.2.37  
m=audio 47190 RTP/AVP 0  
a=rtpmap:0 PCMU/8000  
m=video 53273 RTP/AVPF 98
```

a=rtpmap:98 H263-1998/9000
a=rtp-fb:98 ccm fir

SIP-007530 When an IP videoconference EI that does not understand or support the FIR feedback message receives an sdp offer that advertises the capability to support FIR (i.e., rtp-fb attribute with feedback type “ccm” and rtp-fb-ccm-param with value “fir”) for one or more video streams then the IP videoconference EI **MUST** remove the FIR “rtp-fb” attribute lines when generating the sdp answer.

SIP-007540 When an AS-SIP videoconference EI or videoconference server receives an sdp offer that advertises the capability to support FIR (i.e., rtp-fb attribute with feedback type “ccm” and rtp-fb-ccm-param with value “fir”) for one or more video streams and the AS-SIP videoconference EI or videoconference server does not wish to support Full Intra Request feedback messages for some or all of the video streams then, in the sdp answer, the AS-SIP videoconference EI or videoconference server **MUST** remove the FIR “a= rtp-fb” attribute lines associated with those video streams for which it does not want to support FIR feedback messages for this particular session.

SIP-007550 An AS-SIP videoconference EI or videoconference server **MUST NOT** add a new FIR “rtp-fb” attribute line to any media description in an sdp answer if the FIR “rtp-fb” attribute line was not already present in the media description of the sdp offer.

10.3.6 Far End Camera Control (FECC)

SIP-007560 AS-SIP videoconference EIs are **NOT** required to support FECC. When an AS-SIP videoconference EI supports FECC it **MUST** comply with the requirements of this section.

SIP-007570 Videoconference servers are **NOT** required to support FECC. When a videoconference server supports FECC it **MUST** comply with the requirements of this section.

NOTE: This section specifies the use of the sdp media line and attributes defined in RFC 4573 for establishing the H.224 control channel and the use of the H.281 FECC protocol. It is recognized that the videoconference server operates as an intermediate platform (as opposed to a far end camera) and cannot itself fulfill the commands in a FECC message but rather **MUST** communicate the commands to the FECC client that controls the camera. This section only mandates that a videoconference server that supports FECC **MUST** employ the H.224 control channel, comply with RFC 4573 to negotiate the H.224 control channel, and employ the H.281 FECC protocol to communicate the FECC commands.

SIP-007580 Non-AS-SIP videoconference EIs that comply with the requirements of this section are considered FECC-compliant and are capable of exchanging FECC messages with AS-SIP videoconference EIs and videoconference servers that also comply with this section.

10.3.6.1 General H.224 Control Channel for Far-End Camera Control Messages

SIP-007590 In order for AS-SIP videoconference EIs (or non-AS-SIP IP videoconference EIs that are part of an SC SUT) to support the transmission of H.281 FECC messages in a 2-party call the AS-SIP videoconference EIs (or non-AS-SIP IP videoconference EIs that are part of a SC SUT) MUST establish a udp-based 6.4 Kbps H.224 over RTP control channel, over which the H.281 FECC messages are transmitted. The general H.224 over RTP control channel MUST be negotiated using the sdp parameters and negotiation rules described in RFC 4573.

SIP-007600 In a multiparty call if the videoconference server supports FECC⁹² then the videoconference server MUST support the establishment of an H.224 over RTP control channel with FECC-compliant AS-SIP videoconference EIs (and FECC-compliant non-AS-SIP IP videoconference EIs that are part of an SC SUT). Each general H.224 over RTP control channel is established between an FECC-compliant AS-SIP videoconference EI (or FECC-compliant non-AS-SIP IP videoconference EI that is part of an SC SUT) and the videoconference server using the sdp parameters and negotiation rules described in RFC 4573.

NOTE: In a videoconference server-based multiparty videoconference there is no direct point-to-point H.224 over RTP control channels between IP videoconference EIs.

SIP-007610 To establish the general control channel, the sdp offer MUST include the following media line and attribute lines:

“m=” line where the media type name is application.
a=rtpmap where the encoding name MUST be h224 and the encoding clock rate MUST be 4800.

“a=sendrecv” attribute or “a=sendonly” attribute where the offeror includes the “a=sendonly” attribute if its camera cannot be remotely controlled and if the offeror does not intend to use H.224 to learn the capabilities of the remote video end points. Otherwise, the offeror includes the “a=sendrecv” attribute.

Example:

```
m=application 49170 RTP/AVP 120  
a=rtpmap:120 h224/4800  
a=sendrecv
```

SIP-007620 To establish the general control channel, the sdp answer MUST include the following media line and attribute lines:

“m=” line where the media type name is application.

⁹² The AS-SIP videoconference server supports FECC as an intermediate platform not as an FECC client that directly controls a camera.

a=rtpmap where the encoding name MUST be h224 and the encoding clock rate MUST be 4800.

SIP-007620.a If the offer included the “a=sendonly” attribute and the answerer supports FECC, then the answer includes the “a=recvonly” attribute.

SIP-007620.b If the offer included the “a=sendonly” attribute and the answerer does not support FECC, then the answer rejects the H.224 general control channel offer.

SIP-007620.c If the offer included the “a=sendrecv” attribute and the answerer camera can be remotely controlled or the answerer intends to use H.224 capabilities negotiation, then the answer includes the “a=sendrecv” attribute.

Example:

```
m=application 31234 RTP/SAVP 120
a=rtpmap:120 h224/4800
a=sendrecv
```

SIP-007620.d If the offer included the “a=sendrecv” attribute and the answerer camera cannot be remotely controlled, then the answerer can respond with the “a=sendonly” attribute in the answer.

SIP-007620.e If the offer included the “a=sendrecv” attribute and the answerer does not support FECC or does not intend to use FECC at the moment, then the answer rejects the H.224 general control channel offer by setting the port to “0”.

SIP-007630 The general control channel MUST be encrypted using SRTP, which requires the inclusion of the “a=crypto” attribute in the sdp offer and answer, as defined in RFC 4568.

NOTE: As we will be using SRTP to provide encryption and authentication of the RTP packets carrying the H.224 frames with H.281 FECC messages, the protocol field of the media line MUST be RTP/SAVP.

SIP-007640 When the payload of the RTP/UDP packet is an H.224 frame with an H.281 FECC message, the standard client ID field of the H.224 frame MUST have the value 0x01 per ITU-T Recommendation H.224.

10.3.6.2 Far End Camera Control – ITU-T H.281

SIP-007650 Whenever an FECC-compliant AS-SIP videoconference EI (or an FECC-compliant non-AS-SIP IP videoconference EI that is part of an SC SUT) is involved in the establishment of a new session, then, as a default configuration, FECC MUST be disabled and the end user

MUST be required to affirmatively signal an intention to enable FECC. The interactive mechanism by which the user signals this intention to enable FECC is left to the vendor.⁹³

SIP-007660 The FECC-compliant AS-SIP videoconference EI (and FECC-compliant non-AS-SIP videoconference EI that is part of an SC SUT) MUST provide the end user with a mechanism for disabling the FECC at any point during an active session.

SIP-007670 Any AS-SIP videoconference EI and any non-AS-SIP videoconference EI that accepted remote control of its camera during the sdp negotiation MUST support the receipt and processing of the following six message types in accordance with ITU T H.281, Section 5, Elements of Procedure, and Section 6, FECC Message Structure:

- START ACTION.
- CONTINUE ACTION.
- STOP ACTION.
- SELECT VIDEO SOURCE.
- STORE PRESET.
- ACTIVATE PRESET.

SIP-007680 An FECC-compliant videoconference server MUST support the receipt of the following six message types in accordance with ITU T H.281, Section 5, Elements of Procedure, and Section 6, FECC Message Structure:

- START ACTION.
- CONTINUE ACTION.
- STOP ACTION.
- SELECT VIDEO SOURCE.
- STORE PRESET.
- ACTIVATE PRESET.

NOTE: The videoconference server does not directly control a camera but rather MUST process the FECC message and issue appropriate FECC command(s) to the FECC client(s) directly in control of the camera(s).

SIP-007690 Any AS-SIP videoconference EI and any non-AS-SIP videoconference EI that negotiated to send FECC commands MUST support generation and transmission of the START ACTION, CONTINUE ACTION, STOP ACTION, SELECT VIDEO SOURCE, STORE

⁹³ Examples include pressing a physical button or switch, clicking on a virtual soft button, or selecting the video telephony option from a display menu when either entering the dial string or selecting the intended recipient from an electronic address book.

PRESET, ACTIVATE PRESET message types in accordance with ITU-T H.281, Section 5, Elements of Procedure, and Section 6, FECC Message Structure.

SIP-007700 An FECC-compliant videoconference server **MUST** support generation and transmission of the START ACTION, CONTINUE ACTION, STOP ACTION, SELECT VIDEO SOURCE, STORE PRESET, ACTIVATE PRESET message types in accordance with ITU-T H.281, Section 5, Elements of Procedure, and Section 6, FECC Message Structure.

NOTE: The FECC-compliant videoconference server only issues the FECC commands in response to, and upon receipt of FECC commands from an FECC-compliant videoconference EI.

SIP-007710 Whenever a videoconference EI establishes an H.224 channel with a videoconference server then the videoconference EI sends its FECC client capabilities in the form of a CME Extra Capabilities message to the videoconference server in accordance with H.281 sec. 6.1, FECC Capabilities Field. The information provided includes the number of presets supported by the videoconference EI and a description of the capabilities of each camera at the videoconference EI (i.e., camera number, ability to send motion video using this camera, an indication of the ability to send normal resolution still images, an indication of the ability to send double resolution still images, the ability to Pan, Tilt, Zoom, and Focus this camera). The message format is set forth in H.281 Sec. 6.1.

SIP-007720 The videoconference server that establishes H.224 channels with videoconference EIs sends a CME Extra Capabilities messages (as defined in H.281 Sec. 6.1) over the H.224 channels with the videoconference EIs when the videoconference server initially transmits video from a source videoconference EI with which the videoconference server has established a H.224 channel. In addition, the videoconference server sends a new CME Extra Capabilities messages whenever the videoconference server changes the source or sources of the video that is being transmitted to the members of the videoconference.

10.3.7 Scheduled Videoconference

A Scheduled videoconference is scheduled in advance for a predefined date and time by the individual organizing the conference using out of band means such as a web interface associated with the videoconference server. The host specifies the nature of the conference (i.e., Scheduled), the date and time for the conference, the identity of the participants for the conference, contact information for the conference participants, the intended duration of the conference, the purpose of the conference (i.e., topic(s) to be discussed), the guest pass code to be used by the other participants to gain access to the conference and (possibly) a chair pass code to be input by the floor chair. The conference server generates a conference-ID (i.e., unique conference URI) for the conference session and notifies each of the participants to the upcoming Scheduled conference of the identity of the host, the purpose of the conference, the conference-ID, date, time, and duration of the conference, and the pass code by an out-of-bands means e.g., e-mail, text message, instant message.

At the appointed time, each meeting participant initiates a call request to the Conference-ID and the call flow sequence proceeds as follows:

1. At the designated date and time, the participants initiate a call request to the Conference-ID.
 - a. An AS-SIP videoconference EI (or an RBVS-compliant SIP videoconference EI) sends an INVITE with initial SDP offer that has one “m=audio” line, one “m=video” line for the “main” video stream, and one “m=application” line for UDP/BFCP.
 - b. Proprietary videoconference EIs (including SIP videoconference EIs that are not RBVS-compliant) send an INVITE with an initial SDP offer that has one “m=audio” line and one “m=video” line for the “main” video stream.

The conference server initially accepts a point-to-point unicast session with each participant and if the conference server supports the “isfocus” feature tag then the conference server provides the “isfocus” feature tag in the Contact header of the 200 OK however technically the SRTP stream in each case is not yet connected to the focus for the Scheduled session.

- c. The conference server prompts the participant over the SRTP audio stream to input the pass code in order to be placed into the Scheduled session.
- d. If a chair pass code has been created for the Scheduled conference and the participant happens to be the chair then the participant enters the chair pass code. Otherwise the participant enters the guest pass code. The pass code is transmitted over the SRTP audio stream per RFC 4733 RTP Payload for DTMF Digits, Telephony Tones, and Telephony Signals.

NOTE: If the user fails to enter a valid pass code then the user receives a configurable number of additional opportunities to do so (default=2 additional attempts). If the user fails to enter a valid pass code on each additional attempt then the conference server either terminates the call with the participant by sending a BYE or provides the caller with the opportunity to connect to an operator.

- e. Assuming the participant enters a valid pass code then the conference server internally moves the SRTP bearer streams with the participant’s EI to the focus for the conference session. This action is transparent to the participant. There is no need for the conference server to send a re-INVITE to the participant’s EI in order to change the IP addresses and UDP ports for the SRTP bearer streams.
- f. If the participant’s EI is conference-aware and if the 200 OK response received from the conference server included the “isfocus” feature tag then the participant’s EI subscribes to the RFC 4575 SIP event package for conference state.
- g. When an AS-SIP videoconference EI (or RBVS-compliant SIP videoconference EI) is ready to display content (e.g., a slide presentation) then it sends a re-INVITE with a SDP offer that adds a second “m=video” line for the “slides” video stream. The AS-SIP videoconference EI (or RBVS-compliant SIP videoconference EI) also initiates an

exchange of BFCP messages (e.g., FloorRequest, FloorRequestStatus) with the videoconference server per RFC 4582, “The Binary Floor Control Protocol (BFCP)” in order to claim the floor for the “slides” channel.

- h. The videoconference server responds with a SDP answer accepting the offer of the “m=audio” line, both “m=video” lines, and the “m=application” line for UDP/BFCP.
- i. The videoconference Server sends a re-INVITE to each of the other participants in the videoconference whose original SDP negotiation included the “m=application” line for UDP/BFCP. The re-INVITE includes a SDP offer that adds the “m=video” line for the “slides” video stream. The SDP offer has an “m=audio” line, an “m=video” line for the “main” video stream, an “m=application” line for UDP/BFCP, and a second “m=video” line for the “slides” video stream.

For the proprietary videoconference EIs and the non-RBVS SIP videoconference EIs, the videoconference server begins transmitting the content from the “slides” video stream onto the existing “main” video stream.

- j. Each participant receiving the re-INVITE responds with a 200 OK accepting the offer of one “m=audio” line, a “m=video” line (for “main” content), a “m=application” line for UDP/BFCP, and a second “m=video” line (for “slides” content).

10.3.7.1 ASAC

Each participant to a Meet Me videoconference that is located outside the enclave at which the conference server is situated causes the video call count at the SC of the enclave hosting the conference server to be incremented by the number of VSUs resulting from the SDP negotiation between the conference server and the participant’s EI. However, if the SDP offer includes the offer of a video stream whose bandwidth is greater than the final negotiated bandwidth then during the session establishment process the number of VSUs allocated for the video session and hence the total video VSU count will temporarily be greater than the final video VSU count.

10.3.7.2 Call Flow Diagrams

The call flow between each participant to the Scheduled conference and the conference server is simple and straightforward. We have provided 2 diagrams to depict the situations in which:

1. The videoconference server is a component of the SC (i.e., videoconference server is within the SC SUT) ([Figures 10.3-2](#) through [10.3-4](#)).
2. The videoconference server is a stand-alone AS-SIP videoconference server and the SC and AS-SIP videoconference server are connected over an AS-SIP interface. ([Figures 10.3-5](#) through [10.3-8](#)).

NOTE: The relative order in which the creator of the videoconference, the chair (if specified) and the other participants enter the conference is not significant. The creator of the conference will use the guest pass code unless a “chair” pass code has

been defined and the creator of the conference has decided to act as the chair. Any number of guest participants may enter the Scheduled conference prior to the creator of the conference (or the chair – if specified) and the guest participants are able to communicate with one another while waiting for the chair (if specified) to enter the conference session.

10.3.7.2.1 Videoconference Server Within SC SUT

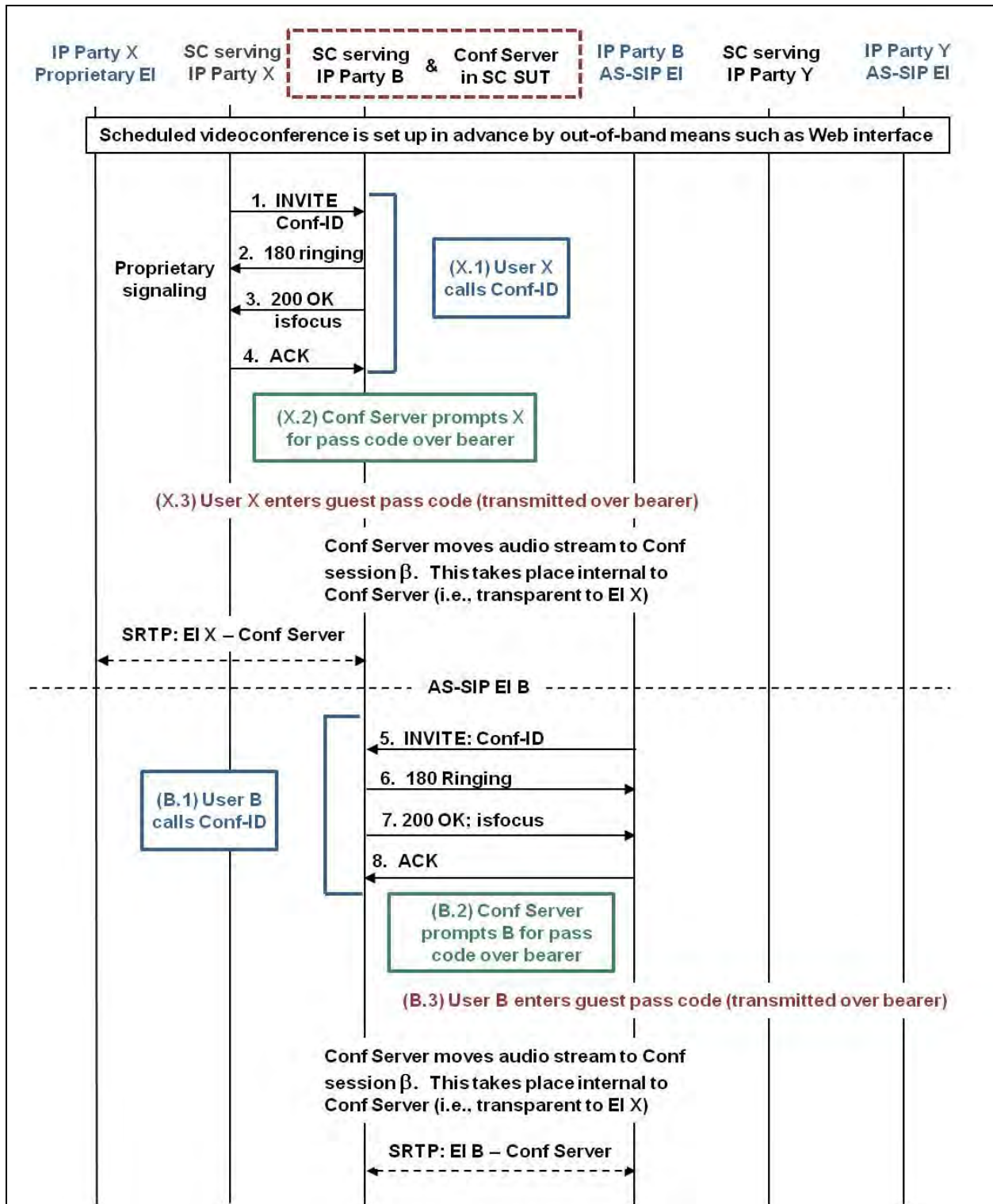

Figure 10.3-2. Scheduled Videoconference – Conference Server Within SC SUT (Steps 1–8)

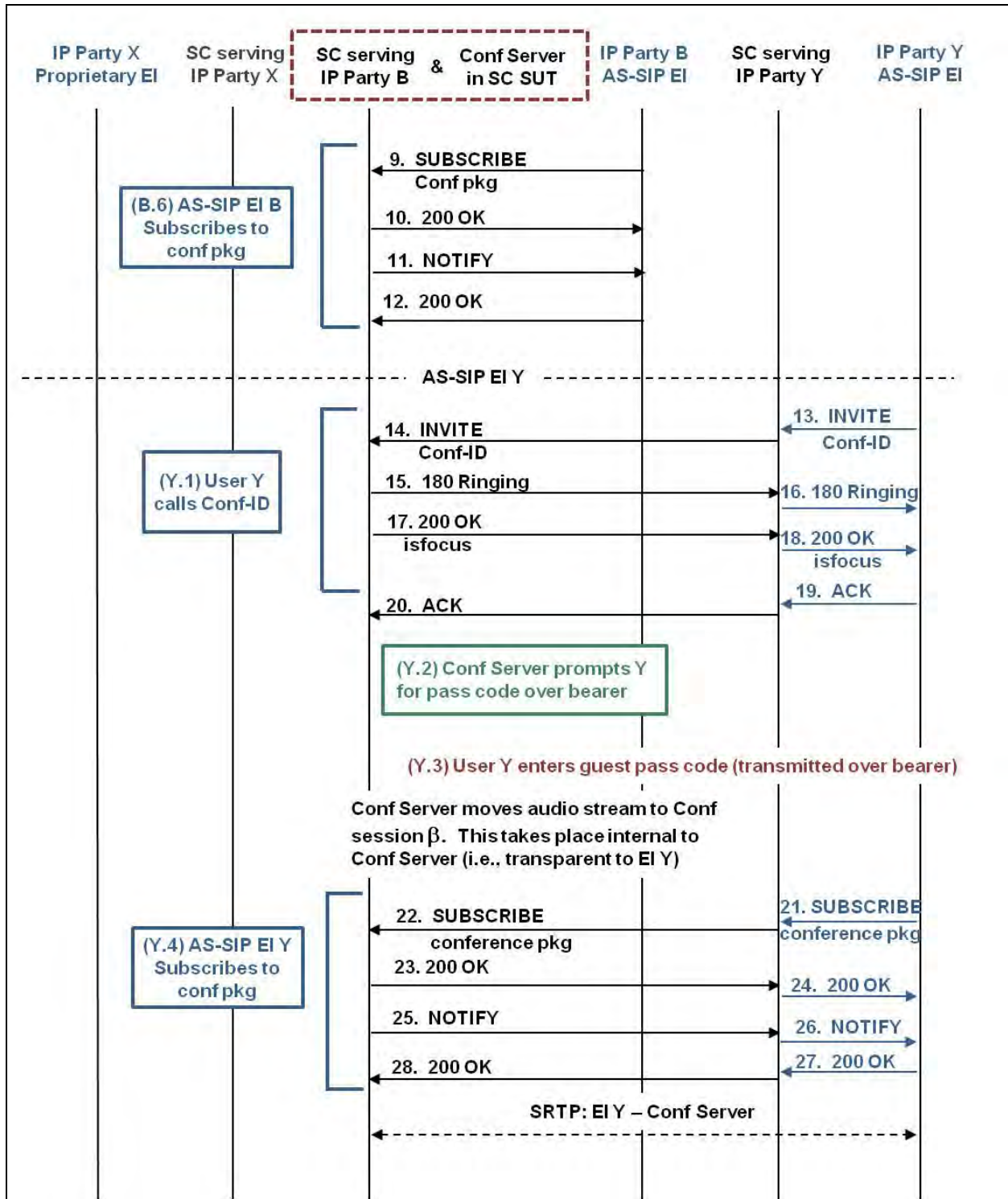

Figure 10.3-3. Scheduled Videoconference – Conference Server Within SC SUT (Steps 9–28)

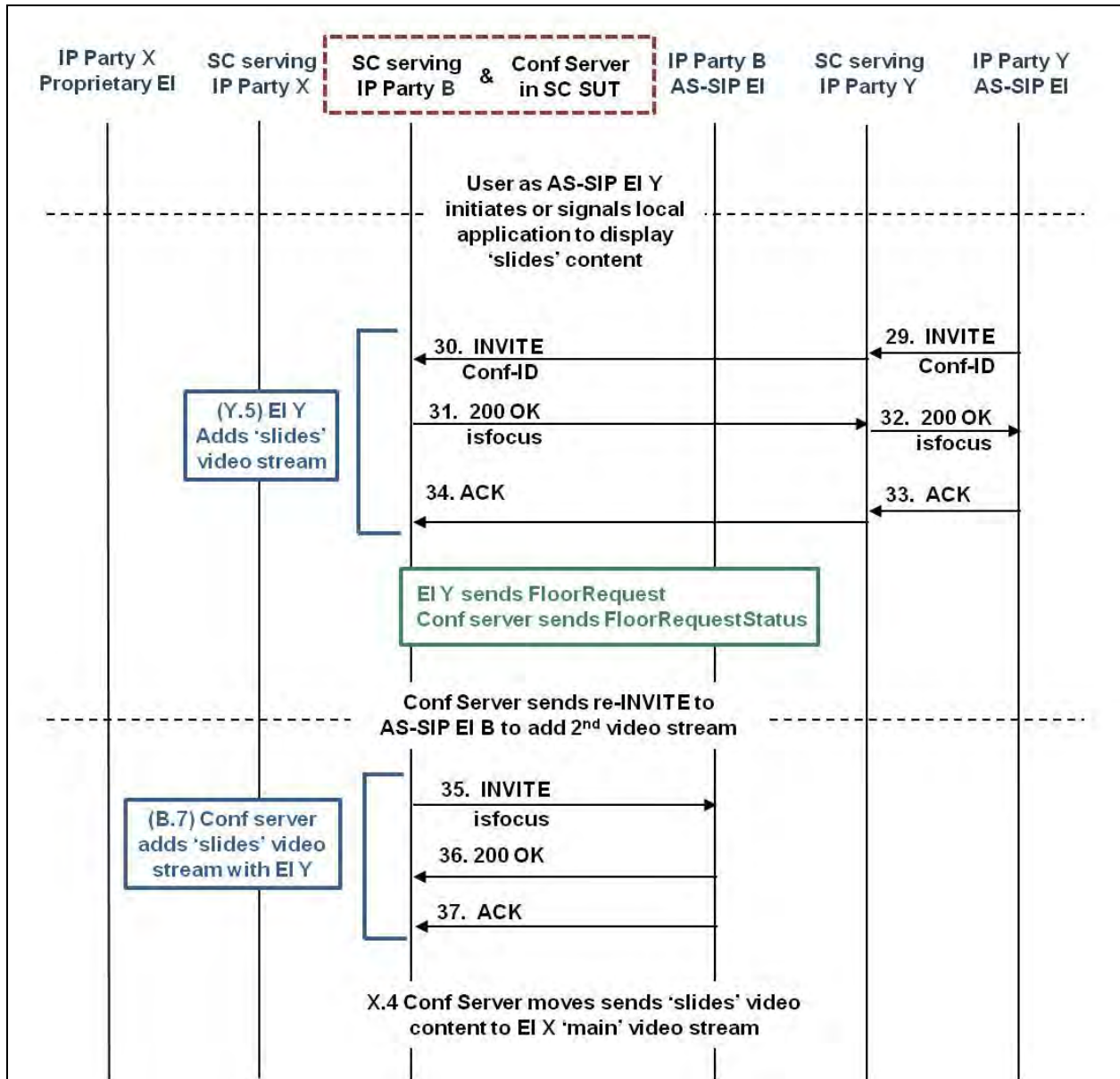

Figure 10.3-4. Scheduled Videoconference – Conference Server Within SC SUT (Steps 29–37)

10.3.7.2.2 Stand-Alone AS-SIP Videoconference Server

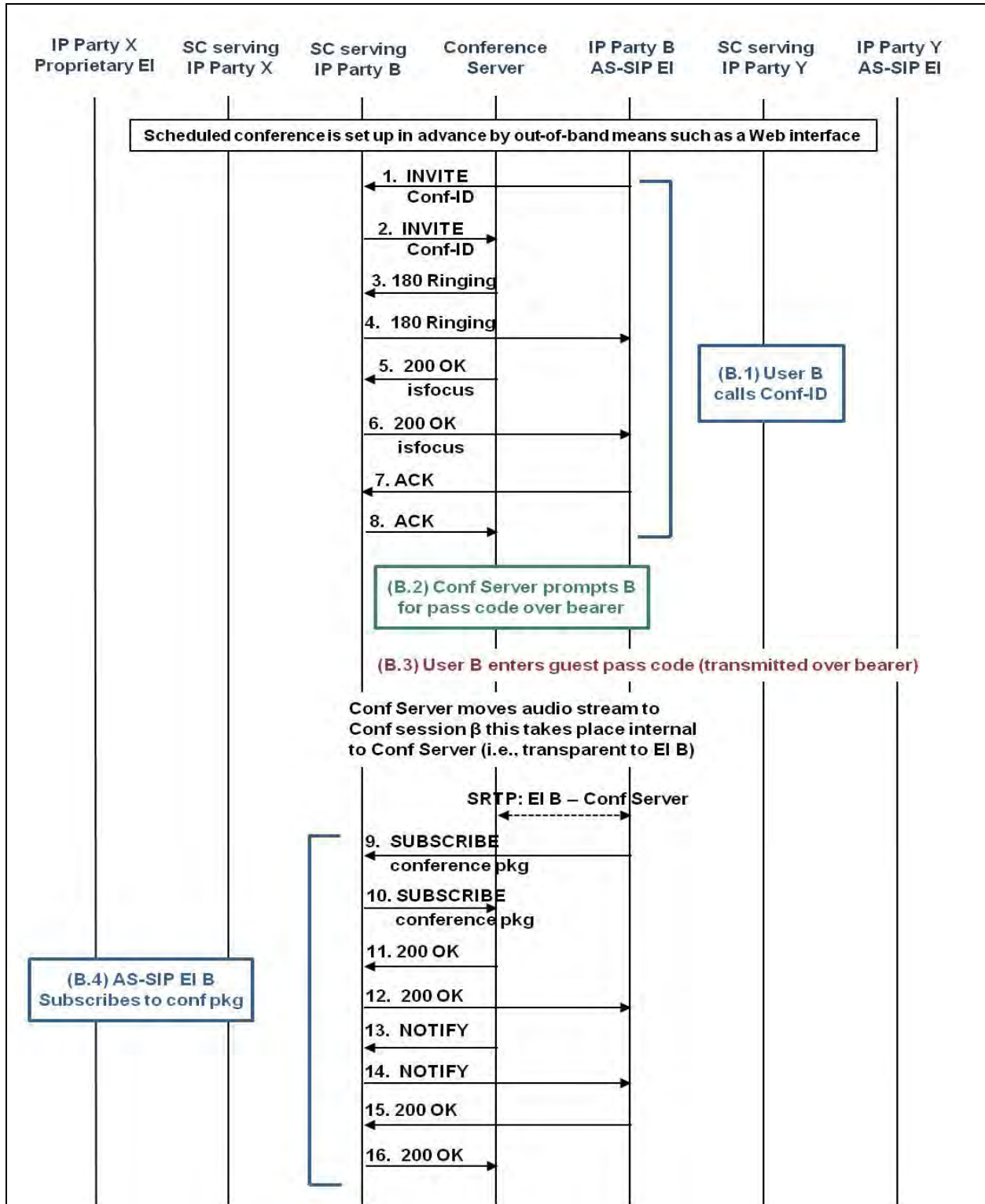

Figure 10.3-5. Scheduled Videoconference – AS-SIP Conference Server (Steps 1–16)

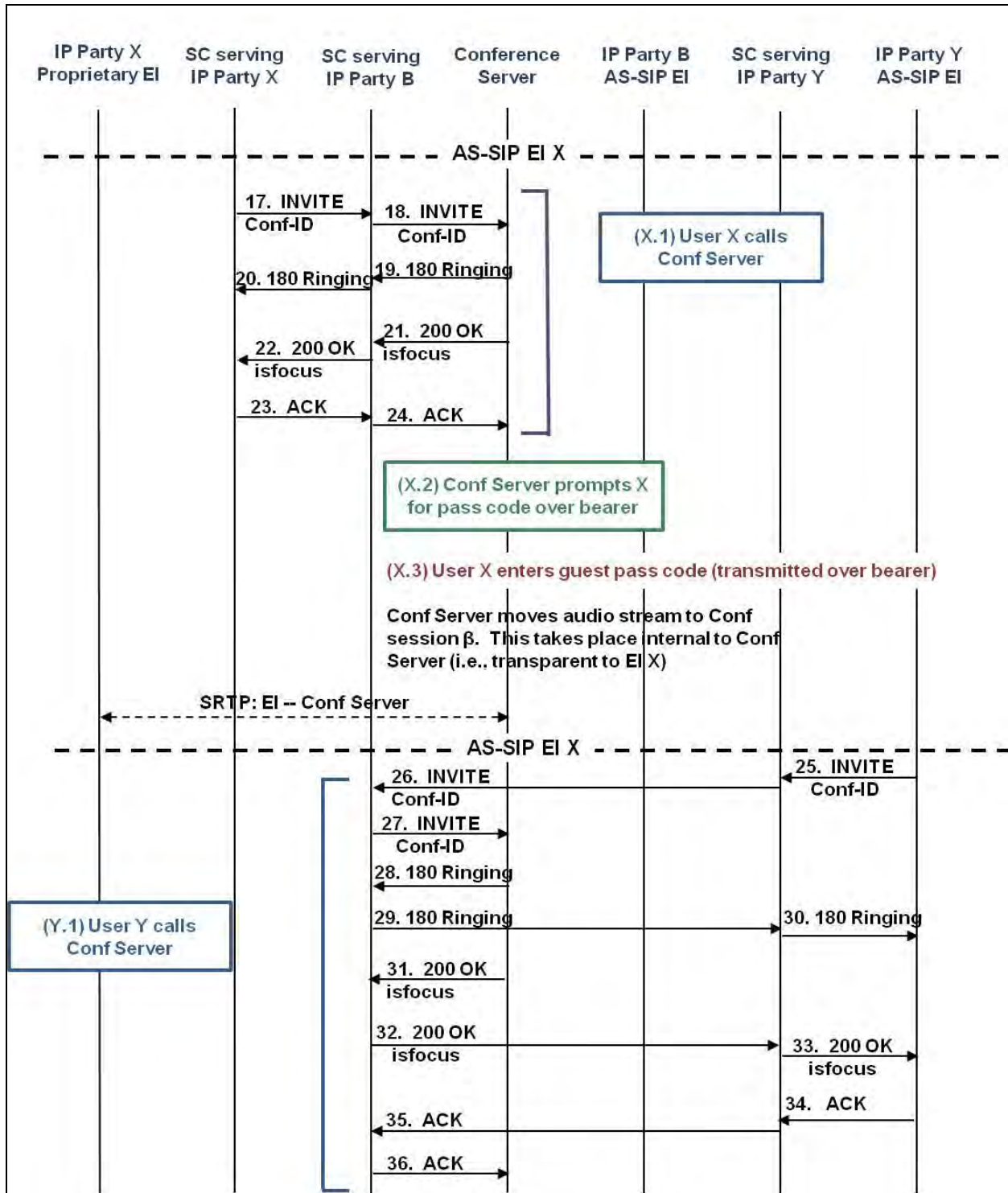

Figure 10.3-6. Scheduled Videoconference – AS-SIP Conference Server (Steps 17–36)

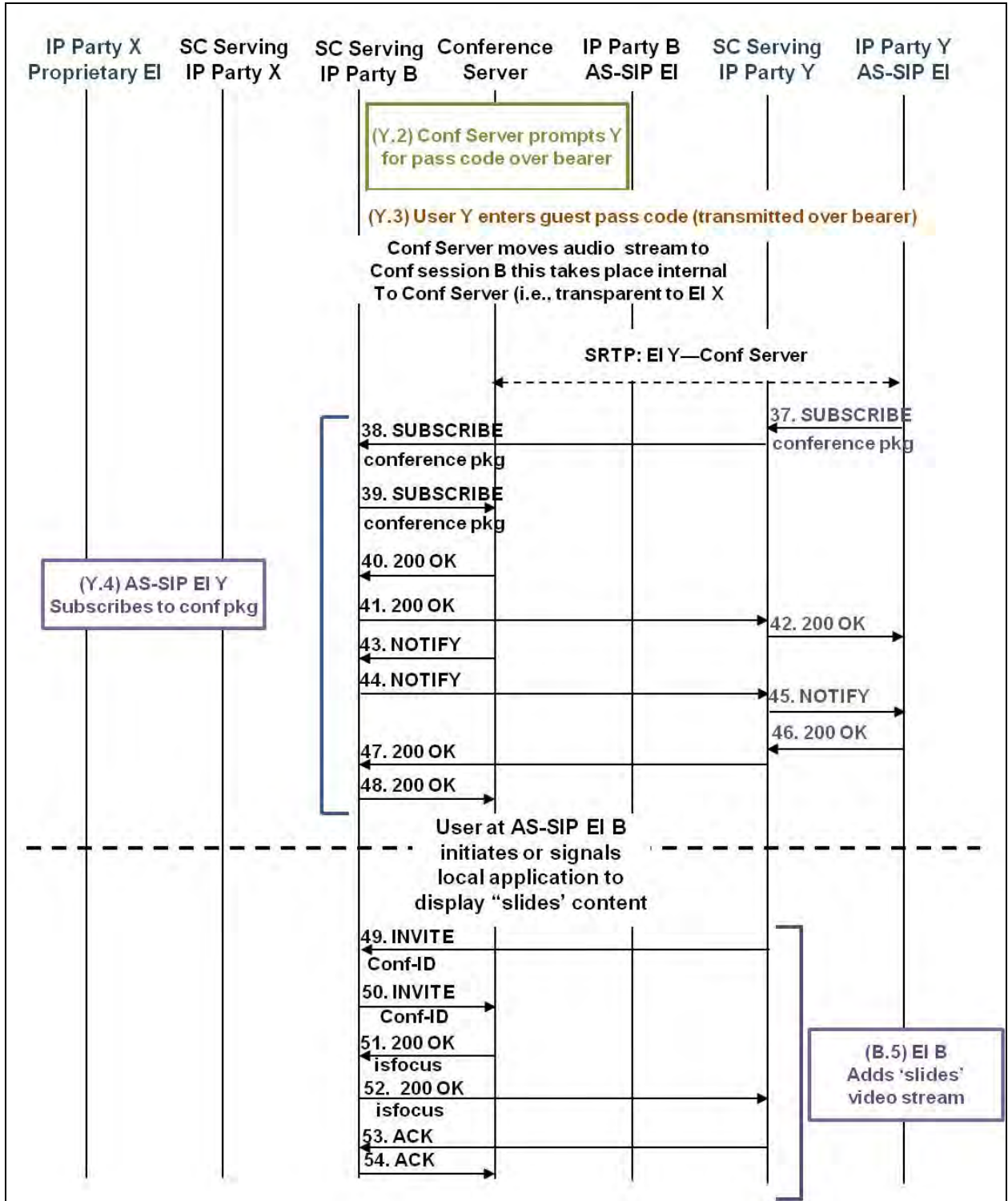

Figure 10.3-7. Scheduled Videoconference – AS-SIP Conference Server (Steps 37–54)

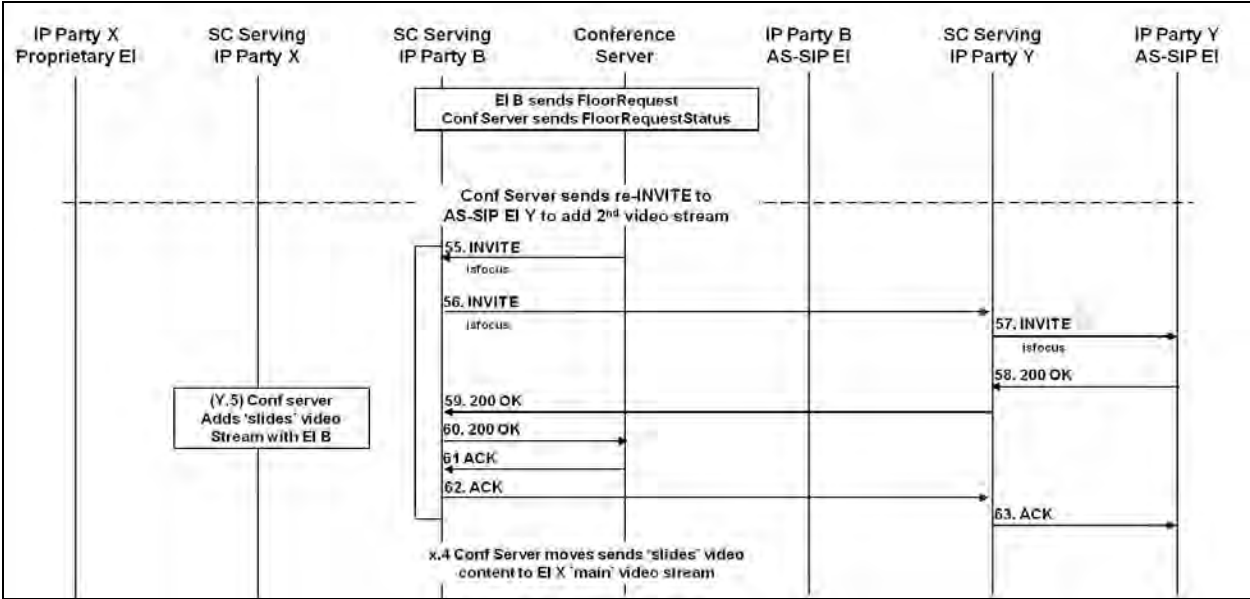

Figure 10.3-8. Scheduled Videoconference – AS-SIP Conference Server (Steps 55–63)

SECTION 11 MODEM ON IP NETWORKS

This section addresses the AS-SIP signaling plane requirements necessary for the support of modem relay capabilities in gateways (i.e., trunk-side MGs, line-side MGs, ATAs, IADs) and UC SCIP EIs. The role of AS-SIP signaling is to provide an interoperable mechanism for exchanging and negotiating modem relay capabilities between modem relay-capable gateways and UC SCIP EIs during session establishment, and thereby, enabling the gateways and UC SCIP EIs to transition to, and operate in, the modem relay state during the established session.

The detailed minimum essential requirements relating to V.150.1 modem relay (outside of the AS-SIP signaling plane requirements) including the messages and operation of the Simple Packet Relay Transport (SPRT) Protocol and of the State Signaling Events (SSEs) Protocol are defined in UCR 2013, Section 2.20, V.150.1 Modem Relay Secure Phone Support.

11.1 AS-SIP SIGNALING REQUIREMENTS IN SUPPORT OF MODEM RELAY-CAPABLE GATEWAYS

NOTE: The term modem relay-capable gateway applies to the following:

- Trunk-side MGs.
- Line-side MGs.
- ATAs.
- IADs.

NOTE: In the following signaling plane sections on modem relay, the term AS-SIP signaling appliance refers to the SC or SS that controls a trunk-side MG and/or line-side MG, and refers to ATAs and IADs.

11.1.1 Advertisement of Modem Relay Capabilities in SDP Offer on Behalf of Modem Relay Capable Gateways

SIP-007730 Whenever an AS-SIP signaling appliance controlling a modem relay-capable gateway receives a telephony call request from the TDM network intended for the IP network AND the associated MG currently has sufficient idle modem relay resources capable of supporting a new modem relay session, then the AS-SIP signaling appliance MUST advertise audio capabilities and modem relay-related capabilities in the sdp offer.

NOTE: The modem relay resources are not actually allocated to a particular audio session until either receipt of State Signaling Event 3, “Modem Relay Mode” call discrimination message over the RTP bearer or receipt of the 2100 Hz ANS or/ANS tone over the TDM bearer.

NOTE: Since the modem relay resource at the MG is not allocated to a session until receipt of an appropriate State Signaling Event (SSE) message (from the IP network) or tone (from the TDM network) that is transmitted over the bearer stream, it is possible that at the time a precedence caller signals an intent to transition to secure mode (i.e., modem relay mode) that all modem relay resources at the MG could currently be allocated to other sessions, in which case, the request by the precedence caller to make the transition to secure mode will fail then. Under the current scheme, there is no mechanism to conduct preemption of modem relay resources on behalf of the precedence call transition request. This shortcoming will be addressed in the next update of the UCR.

SIP-007740 Whenever an AS-SIP signaling appliance controlling a modem relay-capable gateway receives a call request from the TDM network intended for the IP network AND the associated MG does not currently have sufficient idle modem relay resources to support a new modem relay session, then the AS-SIP signaling appliance **MUST** only advertise audio capabilities and **MUST NOT** advertise modem relay-related capabilities in the sdp offer. This applies to ROUTINE calls and to precedence calls.

NOTE: If idle modem relay resources are not available at the time a precedence call request is received from the TDM network, the sdp offer in the INVITE will **NOT** advertise modem relay capabilities. The interworking AS-SIP signaling appliance will **NOT** preempt a ROUTINE or lower precedence call that is currently using the MG's modem relay resources to enable the precedence call to advertise modem relay capabilities. This functionality will be reviewed for the next update of the UCR.

SIP-007750 The AS-SIP signaling appliance **MUST** offer the same udp port number for the modem relay media (i.e., for SPRT and for SSE) as is used for the corresponding audio media.

SIP-007760 Modem relay **MUST** be indicated as a latent capability IAW RFC 3407 where:

SIP-007760.a The <media> parameter of the “cdsc” attribute **MUST** be assigned the value “audio.”

SIP-007760.b The <transport> parameter of the “cdsc” attribute **MUST** be assigned the value “udpsprt” to advertise SPRT.

SIP-007760.c The <fmt list> **MUST** be assigned a dynamic payload type in the range 96–127 inclusive.

SIP-007760.d The payload type **MUST** be mapped to the modem relay payload format, v150mr, by including the “sprtmap” attribute in the RFC 3407 “cpar” attribute.

Example:

```
m=audio 49230 RTP/AVP 0 8
a=sqn: 0
```

```
a=cdsc: 1 audio udpsprt 100
a=cpar: a=sprtmr:100 v150mr/8000
```

where a=sprtmr:<payload type> v150mr/<clock rate>

SIP-007770 The AS-SIP signaling appliance **MUST** declare the SSE Protocol as a dynamic RTP/AVP payload type where the <encoding name> parameter of the “rtpmap” attribute **MUST** be assigned the value “v150fw.”

Example:

```
m=audio 3456 RTP/AVP 0 96
a=rtpmap:96 v150fw/8000
```

SIP-007780 The AS-SIP signaling appliance **MAY** include a format-specific “fmt” attribute line if it wishes to advertise event 4 fax relay (and/or event 5 text relay; however, text relay is **NOT** defined for this version of the UCR).

Example including “fmt” attribute:

```
m=audio 3456 RTP/AVP 0 96
a=rtpmap:96 v150fw/8000
a=fmt:96 4
```

SIP-007790 The gateway is required to be capable of sending and receiving/processing event 1, Audio Mode, and event 3, Modem Relay Mode. Events 1 and 3 **MAY** be enumerated, but are not required to be enumerated, in the “fmt” attribute as they are implied by default, and event 2, VBD, **MUST NOT** be enumerated in the “fmt” attribute because it is **NOT** a valid media state for purposes of this UCR document.

Example:

```
m=audio 3456 RTP/AVP 0 96
a=rtpmap:96 v150fw/8000
a=fmt:96 1,3,4
```

SIP-007800 This specification requires use of simple SSE repetition for SSE reliability, which is not declared in the sdp description and the AS-SIP signaling appliance **MUST NOT** declare support for the RFC 2198 RTP payload for redundant data and **MUST NOT** negotiate the optional explicit acknowledgement procedure.

SIP-007810 The AS-SIP signaling appliance **MUST** specify the following set of format-specific mandatory parameters for v150mr that are declared using the “fmt” attribute:

SIP-007810.a Modem relay type “mr” **MUST** be set to the value “1,” which represents U-MR.

SIP-007810.b If the gateway does not support transcoding, then the MG type “mg” MUST be set to zero (“No Transcoding”); otherwise, in the case of a single transcoding gateway, the MG type “mg” MUST be set to one (“Single Transcoding”), and in the case of a double transcoding gateway, the MG type “mg” MUST be set to two (“Double Transcoding”).

SIP-007810.c Call discrimination mode select, “CDSCselect” MUST be set to one (audio [RFC 2833]).

SIP-007810.c.1 If negotiation of call discrimination mode select fails for any reason, then it is assumed by the AS-SIP signaling appliance and gateway that “CDSCselect” is set to one (audio [RFC 2833]).

SIP-007810.d The “mrmodes” parameter identifies the V-series modulations supported in modem relay mode by the gateway and MUST be set to include, at a minimum, “1” (V.34 duplex), “3” (V.32 bis/V.32), “13” (V.90 analog), “14” (V.90 digital), “16” (V.92 analog), and “17” (V.92 digital). Additional supported V-series modulations MAY also be advertised.

SIP-007810.e A Boolean parameter “jmdelay” indicates whether the gateway supports the JM delay procedure. If the gateway supports the JM delay procedure, the value of “jmdelay” MUST be set to “yes,” and if the gateway does not support the JM delay procedure, the value of “jmdelay” MUST be set to “no.”

SIP-007810.f The AS-SIP signaling appliance MUST specify the version of the V.150.x family of recommendations using the “versn” parameter where the value assumes a format of x.y where the x corresponds to the number after V.150 (currently x=1) and the y represents the version of the recommendation (currently y=1). versn=1.1

Example of v150mr mandatory parameters:

```
m=audio 49232 RTP/AVP 0 8
a=sqn: 0
a=cdsc: 1 audio udpsprt 100
a=cpar: a=sprtmap:100 v150mr/8000
a=cpar :a=fmtp:100 mr=1; mg=1; CDSCselect=1; mrmodes=1,3,13,14,16,17;
jmdelay=no; versn=1.1
```

NOTE: It is permissible to place each <parameter>=<value> pair in a separate “fmtp” attribute line.

Example:

```
m=audio 49232 RTP/AVP 0 8
a=sqn: 0
a=cdsc: 1 audio udpsprt 100
```

```
a=cpar: a=sprtmap:100 v150mr/8000
a=cpar :a=fmtp:100 mr=1
a=cpar :a=fmtp:100 mg=1
a=cpar :a=fmtp:100 CDSCselect=1
a=cpar :a=fmtp:100 mrmodes=1,3,13,14,16,17
a=cpar :a=fmtp:100 jmdelay=no
a=cpar :a=fmtp:100 versn=1.1
```

SIP-007820 The AS-SIP signaling appliance **MUST** indicate support for, at a minimum, the following RFC 2833 events: ANS (32),/ANS (33), ANSam (34), and/ANSam (35).

Example:

```
m=audio 49230 RTP/AVP 0 8 97
a=rtptime:97 telephone-event/8000
a=fmtp:97 32,33,34,35
```

SIP-007830 The AS-SIP signaling appliance **MUST** advertise the “NoAudio” payload type to interoperate with a “Modem Relay-Preferred” endpoint that immediately transitions to the Modem Relay state without first transmitting voice information in the Audio state.

SIP-007830.a The AS-SIP signaling appliance **MUST** use a dynamic RTP payload type in the range 96–127 (although no RTP message definition has been defined for “NoAudio”) and **MUST** identify the NoAudio payload type using the string “NoAudio.”

SIP-007830.b The AS-SIP signaling appliance controlling the gateway **MUST** signal a udp port number and a sample rate of 8000 Hz.

SIP-007830.c “NoAudio” **SHOULD** be the lowest priority payload type in the payload type list.

Example of sdp offer that supports G.711 and NoAudio:

```
m=audio 54320 RTP/AVP 0 111
a=rtptime:0 PCMU/8000
a=rtptime:111 NoAudio/8000
```

SIP-007830.d Whenever the “NoAudio” payload type has been negotiated for a media stream, then the AS-SIP signaling appliance **MUST** ensure that the gateway ceases transmission of voice traffic over the given media stream.

SIP-007840 It is **RECOMMENDED** that the AS-SIP signaling appliance use the default values for maximum payload size for SPRT channels 0, 2, and 3, and the maximum window size for SPRT channel 2; however, the AS-SIP signaling appliance **MAY** specify optional SPRT protocol parameters by the “sprtparm” attribute where the “sprtparm” format is as follows:

```
a=sprtparm:<maxPayload0> <maxPayload1> <maxPayload2> <maxPayload3>.
```

<maxWindow1> <maxWindow2>.

and where the parameters “maxPayload0,” “maxPayload1,” “maxPayload2,” “maxPayload3,” “maxWindow1,” and “maxWindow2” represent integer values as shown in [Table 11.1-1](#), Payload and Window Sizes, which is a copy of ITU Recommendation V.150.1, Table E.2:

Table 11.1-1. Payload and Window Sizes

PARAMETER	DEFINITION	VALUE RANGE	DEFAULT
maxPayload0	Maximum payload size of SPRT channel 0 in bytes	Integer 140–256	140
maxPayload1	Maximum payload size of SPRT channel 1 in bytes	Integer 132–256	132
maxPayload2	Maximum payload size of SPRT channel 2 in bytes	Integer 132–256	132
maxPayload3	Maximum payload size of SPRT channel 3 in bytes	Integer 140–256	140
maxWindow1	Maximum window size of SPRT channel 1 in bytes	Integer 32–96	32
maxWindow2	Maximum window size of SPRT channel 2 in bytes	Integer 8–32	8

NOTE: Any parameter can be omitted by setting it to “\$,” in which case, the default value is used for that parameter. It is also valid to emit trailing “\$.”

Example:

a=sprtparm:180 100 \$ 240 40 25

Example:

a=sprtparm:220 200 \$ 240

In this example maxpayload2, maxwindow1, and maxwindow2 are set to their default values.

SIP-007850 If negotiation of the optional SPRT protocol parameters fails for any reason, then the default values MUST be used by the local gateway and by the remote gateway or UC SCIP EI.

Basic example of SDP offer on behalf of modem relay capable gateway that advertises modem relay capabilities:

```
v=0
o=- 25678 753849 IN IP4 128.96.41.1
s=
c=IN IP4 128.96.41.1
t=0 0
m=audio 49230 RTP/AVP 0 8 97 98 111
a=rtpmap:97 telephone-event/8000
a=fmtp:97 32,33,34,35
a=rtpmap:98 v150fw/8000
a=rtpmap:111 NoAudio/8000
```

a=sqn: 0
a=cdsc: 1 audio udpsprt 100
a=cpar: a=sprtmap:100 v150mr/8000
a=cpar :a=fmtp:98 mr=1; mg=1; CDSCselect=1; mrmodes=1,3,13,14,16,17;
jmdelay=no; versn=1.1

11.1.2 Advertisement of Modem Relay Capabilities in SDP Answer on Behalf of Modem Relay Capable Gateways

SIP-007860 Whenever an AS-SIP signaling appliance controlling a modem relay-capable gateway receives an sdp offer in which modem relay-related capabilities have NOT been declared, then the AS-SIP signaling appliance MUST NOT declare its modem relay-related capabilities in the sdp answer.

SIP-007870 Whenever an AS-SIP signaling appliance controlling a modem relay-capable gateway receives an INVITE with an sdp offer that advertises modem relay capabilities AND the associated MG currently has idle modem relay resources capable of supporting a new modem relay session, then the AS-SIP signaling appliance MUST advertise modem relay-related capabilities in the sdp answer.

NOTE: It is possible that when a precedence caller signals an intent to transition to secure mode (i.e., modem relay mode) that all modem relay resources at the MG could currently be allocated to other sessions in which case the request by the precedence caller to make the transition to secure mode will fail then. Under the current scheme, there is no mechanism to conduct preemption of modem relay resources on behalf of the precedence call transition request. This shortcoming will be addressed in the next update of the UCR.

SIP-007880 Whenever an AS-SIP signaling appliance controlling a modem relay-capable gateway receives an INVITE with an sdp offer that advertises modem relay capabilities AND the associated MG does not currently have sufficient idle modem relay resources to support a new modem relay session, then the AS-SIP signaling appliance MUST only advertise audio capabilities and MUST NOT declare a modem relay capability in the sdp answer. This applies to ROUTINE calls and to precedence calls.

NOTE: If idle modem relay resources are not available when a precedence call request is received from the TDM network, the sdp answer will NOT accept modem relay capabilities. The interworking AS-SIP signaling appliance will NOT preempt a ROUTINE or lower precedence call that is currently using the MG's modem relay resources to enable the precedence call to accept modem relay capabilities. This functionality will be reviewed for the next update of the UCR.

SIP-007890 As in the case of the sdp offer, the AS-SIP signaling appliance **MUST** use the same udp port number for the modem relay media (i.e., for SPRT and for SSE) as is used for the corresponding audio media.

SIP-007900 As in the case of the sdp offer, modem relay **MUST** be indicated as a latent capability in the sdp answer IAW RFC 3407 where:

SIP-007900.a The <media> parameter of the “cdsc” attribute **MUST** be assigned the value “audio.”

SIP-007900.b The <transport> parameter of the “cdsc” attribute **MUST** be assigned the value “udpsprt” to advertise SPRT.

SIP-007900.c The <fmt list> **MUST** match the dynamic payload type assigned in the sdp offer.

SIP-007900.d The payload type **MUST** be mapped to the modem relay payload format, v150mr, by including the “sprtmap” attribute in the RFC 3407 “cpar” attribute.

Example excerpt of an sdp offer and answer:

Offer:

```
m=audio 49230 RTP/AVP 0 8
a=sqn: 0
a=cdsc: 1 audio udpsprt 100
a=cpar: a=sprtmap:100 v150mr/8000
```

Answer:

```
m=audio 32140 RTP/AVP 0
a=sqn: 0
a=cdsc: 1 audio udpsprt 100
a=cpar: a=sprtmap:100 v150mr/8000
```

SIP-007910 The AS-SIP signaling appliance **MUST** declare the SSE Protocol in the sdp answer, using the same dynamic RTP/AVP payload type assigned in the sdp offer where the <encoding name> parameter of the “rtptime” attribute **MUST** be assigned the value “v150fw.”

Example excerpt of an sdp offer and answer:

Offer:

```
m=audio 3456 RTP/AVP 0 96
a=rtptime:96 v150fw/8000
```

Answer:

```
m=audio 4640 RTP/AVP 0 96
```

a=rtpmap:96 v150fw/8000

SIP-007920 If the sdp offer includes an “fmtp” attribute line with supported events, then if the gateway controlled by the AS-SIP signaling appliance supports any event listed in the sdp offer, the AS-SIP signaling appliance **MUST** include an “fmtp” attribute in the sdp answer that includes the events that were listed in the sdp offer that are also supported by the gateway of the AS-SIP signaling appliance generating the sdp answer.

SIP-007930 If event 1, Audio Mode, and event 3, Modem Relay Mode, are listed in the “fmtp” attribute in the sdp offer, then events 1 and 3 **MAY** be listed, but are **NOT** required to be listed, in the sdp answer as they are implied by default, and event 2, VBD, **MUST NOT** be present in the “fmtp” attribute of the sdp offer or answer because it is **NOT** a valid media state for purposes of this UCR document.

Example excerpt of sdp offer and answer including “fmtp” attribute:

Offer:

```
m=audio 3456 RTP/AVP 0 96
a=rtpmap:96 v150fw/8000
a=fmtp:96 4
```

Answer:

```
m=audio 4640 RTP/AVP 0 96
a=rtpmap:96 v150fw/8000
a=fmtp:96 4
```

SIP-007940 This specification requires the use of simple SSE repetition for SSE reliability, which is not declared in the sdp description, and the AS-SIP signaling appliance **MUST NOT** declare support for the RFC 2198 RTP payload for redundant data in the sdp answer and **MUST NOT** declare the optional explicit acknowledgement procedure in the sdp answer.

SIP-007950 In the sdp answer, the AS-SIP signaling appliances **MUST** specify the following set of format-specific mandatory parameters for v150mr that are declared using the “fmtp” attribute:

SIP-007950.a Modem relay type “mr” **MUST** be set to the value one, which represents U-MR.

SIP-007950.b If the gateway does not support transcoding, then the MG type “mg” **MUST** be set to zero (i.e., No Transcoding); otherwise, in the case of a single transcoding gateway, the MG type “mg” **MUST** be set to one (i.e., Single Transcoding), and in the case of a double transcoding gateway, the MG type “mg” **MUST** be set to two (i.e., Double Transcoding).

SIP-007950.c The call discrimination mode select, “CDSCselect,” **MUST** be set to one (audio [RFC 2833]).

SIP-007950.c.1 If negotiation of call discrimination mode select fails for any reason, then it is assumed by the AS-SIP signaling appliance and gateway that “CDSCselect” is set to one (audio [RFC 2833]).

SIP-007950.d The “mrmodes” parameter identifies the V-series modulations supported in modem relay mode by the gateway and for each of the following V-series modulations advertised in the sdp offer:

- ‘1’ (V.34 duplex)
- ‘3’ (V.32 bis/V.32)
- ‘13’ (V.90 analog)
- ‘14’ (V.90 digital)
- ‘16’ (V.92 analog)
- ‘17’ (V.92 digital)

The same V-series modulation **MUST** be included in the sdp answer.

SIP-007950.d.1 For any V-series modulation listed in Requirement SIP-007950.d that is absent in the sdp offer, the AS-SIP signaling appliance **MUST NOT** include said absent V series modulations in the sdp answer.

SIP-007950.d.2 If additional V-series modulations beyond those enumerated in Requirement SIP-007950.d are present in the sdp offer and are supported by the gateway, then the additional V series modulations **MUST** be added to the sdp answer.

SIP-007960 A Boolean parameter, “jmdelay,” is indicating whether the gateway supports the JM delay procedure. If the gateway supports the JM delay procedure, the value of “jmdelay” **MUST** be set to “yes,” and if the gateway does not support the JM delay procedure the value of “jmdelay” **MUST** be set to “no.”

SIP-007970 The AS-SIP signaling appliance **MUST** specify the version of the V.150.x family of recommendations using the parameter “versn” where the value assumes a format of x.y where the x corresponds to the number after V.150 (currently x=1), and the y represents the version of the recommendation (currently y=1), e.g., versn=1.1.

SIP-007970.a 1 The value of the sdp “versn” parameter in the sdp answer **MUST** be equal to or lower than the value of the “versn” parameter in the sdp offer. For this UCR release, the value of the parameter “versn” is 1.1.

Example of v150mr mandatory parameters in an sdp offer and answer:

Offer:

```
m=audio 49232 RTP/AVP 0 8
a=sqn: 0
a=cpsc: 1 audio udpsprt 100
```

```
a=cpar: a=sprtmap:100 v150mr/8000  
a=cpar :a=fmtp:100 mr=1; mg=1; CDSCselect=1; mrmodes=1,3,13,14,16,17;  
jmdelay=no; versn=1.1
```

Answer:

```
m=audio 37416 RTP/AVP 0  
a=sn: 0  
a=cdsc: 1 audio udpsprt 100  
a=cpar: a=sprtmap:100 v150mr/8000  
a=cpar :a=fmtp:100 mr=1; mg=1; CDSCselect=1; mrmodes=1,3,13,14,16,17;  
jmdelay=no; versn=1.1
```

SIP-007980 The AS-SIP signaling appliance MUST indicate support for, at a minimum, the following RFC 2833 events: ANS (32),/ANS (33), ANSam (34) and/ANSam (35).

Example:

```
m=audio 37416 RTP/AVP 0 2 8 97  
a=rtpmap:97 telephone-event/8000  
a=fmtp:97 32-35
```

SIP-007990 When the AS-SIP signaling appliance controlling the gateway receives an sdp offer from a modem relay-preferred endpoint (i.e., the audio media stream in the sdp offer advertises the “NoAudio” payload as the only payload type), then the AS-SIP signaling appliance MUST respond in the sdp answer by accepting the “NoAudio” payload type.

Example:

“NoAudio” sdp offer:

```
m=audio 12346 RTP/AVP 99  
a=rtpmap:99 NoAudio/8000
```

“NoAudio” sdp answer:

```
m=audio 24560 RTP/AVP 99  
a=rtpmap:99 NoAudio/8000
```

SIP-007990.a Whenever the “NoAudio” payload type has been negotiated for a media stream, then the AS-SIP signaling appliance MUST ensure that the gateway ceases transmission of voice traffic over the given media stream.

SIP-008000 Whenever the AS-SIP signaling appliance controlling the gateway receives an sdp offer in which one or more audio payload types supported by the controlled gateway are advertised in addition to the “NoAudio” payload type, then the AS-SIP signaling appliance MUST respond in the sdp answer by accepting one of the supported audio payload types.

SIP-008010 If the sdp offer includes the “sprtparm” attribute, then the sdp answer MUST include the “sprtparm” attribute in the sdp answer where each parameter value advertised in the sdp answer MUST be less than or equal to the corresponding parameter value in the sdp offer AND, in all cases, the parameter value MUST be within the value range specified in [Table 11.1-1](#), Payload and Window Sizes.

SIP-008020 If the sdp offer received by the AS-SIP signaling appliance does not include the “sprtparm” attribute, the sdp answer MUST NOT include the “sprtparm” attribute, because the gateway is required to be capable of supporting the default values for the maximum payload size for SPRT channels 0, 2, and 3, and the maximum window size for SPRT channel 2.

SIP-008020.a If negotiation of the optional SPRT protocol parameters fails for any reason, then the default values MUST be used by the local gateway and by the remote gateway or UC SCIP EI.

Basic example of an SDP offer on behalf of a modem relay-capable gateway that advertises modem relay capabilities:

```
v=0
o=- 25678 753849 IN IP4 128.96.41.1
s= -
c=IN IP4 128.96.41.1
t=0 0
m=audio 49230 RTP/AVP 0 8 97 98 111
a=rtpmap:97 telephone-event/8000
a=fmtp:97 32,33,34,35
a=rtpmap:98 v150fw/8000
a=rtpmap:111 NoAudio/8000
a=sqn: 0
a=cdsc: 1 audio udpsprt 100
a=cpar: a=sprtmap:100 v150mr/8000
a=cpar :a=fmtp:98 mr=1; mg=1; CDSCselect=1; mrmodes=1,3,13,14,16,17;
jmdelay=no; versn=1.1
```

Basic example of an SDP answer on behalf of a modem relay-capable gateway that advertises modem relay capabilities:

```
v=0
o=- 36421 34062 IN IP4 118.2.36.42
s= -
c=IN IP4 118.2.36.42
t=0 0
m=audio 25110 RTP/AVP 0 97 98
a=rtpmap:97 telephone-event/8000
a=fmtp:97 32,33,34,35
```

a=rtpmap:98 v150fw/8000
a=sqn: 0
a=cdsc: 1 audio udpsprt 100

11.2 AS-SIP SIGNALING REQUIREMENTS IN SUPPORT OF UC SCIP EIS

11.2.1 UC SCIP EI Advertisement of Modem Relay Capabilities in SDP Offer

SIP-008030 Whenever a single appearance UC SCIP EI generates an sdp offer then it declares its modem relay-related capabilities in the sdp offer.

SIP-008040 Whenever a multiple appearance UC SCIP EI generates an sdp offer AND the UC SCIP EI currently has idle modem relay resources to support a modem relay session, then the UC SCIP EI MUST declare its modem relay-related capabilities in the sdp offer.

NOTE: A multiple appearance UC SCIP EI can only operate one session in secure mode (i.e., modem relay mode) at any given time. If a session on appearance 1 is currently operating in secure mode and the user wishes to transition the session on appearance 2 to secure mode, then the user must first transition the session on appearance 1 back to audio mode.

SIP-008050 Whenever a multiple appearance UC SCIP EI generates an sdp offer AND the UC SCIP EI and the modem relay resources are in use currently, then the UC SCIP EI MUST only declare audio capabilities in the sdp offer and MUST NOT declare modem relay-related capabilities in the sdp offer.

NOTE: To offer modem relay capabilities on one appearance, the user must either be operating in audio mode on the other appearance or the other appearance must be idle.

SIP-008060 The UC SCIP EI MUST offer the same udp port number for the modem relay media (i.e., for SPRT and for SSE) as used for the corresponding audio media.

SIP-008070 Modem relay MUST be indicated as a latent capability IAW RFC 3407, sdp Simple Capability Declaration, where:

SIP-008070.a The <media> parameter of the “cdsc” attribute MUST be assigned the value “audio.”

SIP-008070.b The <transport> parameter of the “cdsc” attribute MUST be assigned the value “udpsprt” to advertise SPRT.

SIP-008070.c The <fmt list> MUST be assigned a dynamic payload type in the range 96–127 inclusive.

SIP-008070.d The payload type MUST be mapped to the modem relay payload format, v150mr, by including the “sprtmap” attribute in the RFC 3407 “cpar” attribute.

Example:

```
m=audio 49230 RTP/AVP 0 8
a=sqn: 0
a=cdsc: 1 audio udpsprt 100
a=cpar: a=sprtmap:100 v150mr/8000
```

where a=sprtmap:<payload type> v150mr/<clock rate>

SIP-008080 The UC SCIP EI MUST declare the SSE protocol as a dynamic RTP/AVP payload type where the <encoding name> parameter of the “rtpmap” attribute MUST be assigned the value “v150fw.”

Example:

```
m=audio 3456 RTP/AVP 0 96
a=rtpmap:96 v150fw/8000
```

SIP-008090 The UC SCIP EI MAY include a format-specific “fntp” attribute line if it wishes to advertise event 4 fax relay (and/or event 5 text relay; however, text relay is NOT defined for this version of the UCR).

Example including “fntp” attribute:

```
m=audio 3456 RTP/AVP 0 96
a=rtpmap:96 v150fw/8000
a=fntp:96 4
```

SIP-008100 The UC SCIP EI is required to be capable of sending and receiving/ processing event 1 Audio mode and event 3 Modem Relay mode. Events 1 and 3 MAY be enumerated, but are not required to be enumerated, in the “fntp” attribute because they are implied by default and event 2 VBD MUST NOT be enumerated in the “fntp” attribute because it is NOT a valid media state for the purposes of this UCR document.

Example:

```
m=audio 3456 RTP/AVP 0 96
a=rtpmap:96 v150fw/8000
a=fntp:96 4
```

SIP-008110 This specification requires the use of simple SSE repetition for SSE reliability, which is not declared in the sdp description, and the UC SCIP EI MUST NOT declare support for the RFC 2198 RTP payload for redundant data and MUST NOT negotiate the optional explicit acknowledgement procedure.

SIP-008120 The UC SCIP EI MUST specify the following set of format-specific mandatory parameters for v150mr that are declared using the “fntp” attribute:

SIP-008120.a Modem relay type “mr” MUST be set to the value “1,” which represents U-MR.

SIP-008120.b Media gateway type “mg” MUST be set to “0” (“No Trans-compression”).

SIP-008120.c Call discrimination mode select, “CDSCselect” MUST be set to 1 (audio [RFC 2833]).

SIP-008120.c.1 If negotiation of call discrimination mode select fails for any reason, then it is assumed by the UC SCIP EI that “CDSCselect” is set to 1 (audio [RFC 2833]).

SIP-008120.d The parameter “mrmodes” identifies the V-series modulations supported in modem relay mode by the UC SCIP EI and MUST be set to include “1” (V.34 duplex) and “3” (V.32 bis/V.32). The UC SCIP EI MAY also identify other supported modulations.

SIP-008120.e The JM delay support procedure parameter “jmdelay” MUST be set to “no.”

SIP-008120.f The UC SCIP EI MUST specify the version of the V.150.x family of ITU-T Recommendations using the parameter “versn” where the value assumes a format of x.y where the “x” corresponds to the number after V.150 (currently x=1) and the “y” represents the version of the recommendation (currently y=1): versn=1.1.

Example:

```
m=audio 49232 RTP/AVP 0 8
a=sqn: 0
a=cdsc: 1 audio udpsprt 100
a=cpar: a=sprtmap:100 v150mr/8000
a=cpar :a=fntp:100 mr=1; mg=0; CDSCselect=1; mrmodes=1,3; jmdelay=no;
versn=1.1
```

NOTE: It is permissible to place each <parameter>=<value> pair in a separate “fntp” attribute line.

Example:

```
m=audio 49232 RTP/AVP 0 8
a=sqn: 0
a=cdsc: 1 audio udpsprt 100
a=cpar: a=sprtmap:100 v150mr/8000
a=cpar :a=fntp:100 mr=1
```

```
a=cpar :a=fmtp:100 mg=0  
a=cpar :a=fmtp:100 CDSCselect=1  
a=cpar :a=fmtp:100 mrmodes=1,3  
a=cpar :a=fmtp:100 jmdelay=no  
a=cpar :a=fmtp:100 versn=1.1
```

SIP-008130 The UC SCIP EI MUST indicate support for, at a minimum, the following RFC 2833 events: ANS (32),/ANS (33), ANSam (34), and/ANSam (35).

Example:

```
m=audio 49230 RTP/AVP 0 8 97  
a=rtpmap:97 telephone-event/8000  
a=fmtp:97 32,33,34,35
```

SIP-008140 The UC SCIP EI MUST advertise the “NoAudio” payload type to interoperate with a “Modem Relay-Preferred” endpoint that immediately transitions to the Modem Relay state without first transmitting voice information in the Audio state.

SIP-008140.a The UC SCIP EI MUST use a dynamic RTP payload type in the range 96–127 (although no RTP message definition has been defined for “NoAudio”) and MUST identify the “NoAudio” payload type using the string “NoAudio.”

SIP-008140.b The UC SCIP EI MUST signal a udp port number and a sample rate of 8000 Hz.

SIP-008140.c “NoAudio” SHOULD be the lowest priority payload type in the payload type list.

Example from SCIP-215 of sdp offer sent by UC SCIP EI that supports G.711 and “NoAudio”:

```
m=audio 54320 RTP/AVP 0 111  
a=rtpmap:0 PCMU/8000  
a=rtpmap:111 NoAudio/8000
```

SIP-008140.d Whenever the “NoAudio” payload type has been negotiated for a media stream, then the UC SCIP EI MUST cease transmission of voice traffic over the given media stream.

SIP-008150 It is RECOMMENDED that the UC SCIP EI use the default values for maximum payload size for SPRT channels 0, 2, and 3 and the maximum window size for SPRT channel 2; however, the UC SCIP EI MAY specify optional SPRT protocol parameters by means of the “sprtparm” attribute where the “sprtparm” format is as follows:

```
a=sprtparm:<maxPayload0> <maxPayload1> <maxPayload2> <maxPayload3>.  
<maxWindow1> <maxWindow2>.
```

and where the parameters “maxPayload0,” “maxPayload1,” “maxPayload2,” “maxPayload3,” “maxWindow1,” and “maxWindow2” represent integer values as shown in [Table 11.2-1](#), which is a copy of ITU Recommendation V.150.1, Table E.2.

Table 11.2-1. ITU Recommendation V.150.1, Table E.2

PARAMETER	DEFINITION	VALUE RANGE	DEFAULT
maxPayload0	Maximum payload size of SPRT channel 0 in bytes	Integer 140–256	140
maxPayload1	Maximum payload size of SPRT channel 1 in bytes	Integer 132–256	132
maxPayload2	Maximum payload size of SPRT channel 2 in bytes	Integer 132–256	132
maxPayload3	Maximum payload size of SPRT channel 3 in bytes	Integer 140–256	140
maxWindow1	Maximum window size of SPRT channel 1 in bytes	Integer 32–96	32
maxWindow2	Maximum window size of SPRT channel 2 in bytes	Integer 8–32	8

NOTE: Any parameter can be omitted by setting it to “\$” in which case the default value is used for that parameter. It is also valid to emit trailing “\$.”

Example:

a=sprtparm:180 100 \$ 240 40 25

Example:

a=sprtparm:220 200 \$ 240

In this example, maxPayload2, maxWindow1, and maxWindow2 are set to their default values.

SIP-008160 negotiation of the optional SPRT protocol parameters fails for any reason, then the default values MUST be used by the local UC SCIP EI and by the remote gateway or UC SCIP EI.

Basic Example of SDP Offer by UC SCIP EI that Advertises Modem Relay Capabilities:

```
v=0
o=- 25678 753849 IN IP4 128.96.128.1
s=
c=IN IP4 128.96.128.1
t=0 0
m=audio 49230 RTP/AVP 0 8 97 98 111
a=rtpmap:97 telephone-event/8000
a=fmtp:97 32,33,34,35
a=rtpmap:98 v150fw/8000
a=rtpmap:111 NoAudio/8000
a=sqn: 0
a=cdsc: 1 audio udpsprt 100
a=cpar: a=sprtparm:100 v150mr/8000
```

a=cpar :a=fmtp:98 mr=1; mg=0; CDSCselect=1; mrmodes=1,3; jmdelay=no;
versn=1.1

11.2.2 UC SCIP EI Advertisement of Modem Relay Capabilities in SDP Answer

SIP-008170 Whenever a UC SCIP EI receives an sdp offer in which modem relay-related capabilities have NOT been declared, then the UC SCIP EI MUST NOT declare its modem relay-related capabilities in the sdp answer.

SIP-008180 Whenever a single appearance UC SCIP EI receives an sdp offer in which modem relay-related capabilities have been declared for an audio media stream, then the UC SCIP EI MUST, in the sdp answer, declare its own modem relay-related capabilities for the audio media stream.

SIP-008190 Whenever a multiple appearance UC SCIP EI receives an sdp offer in which modem relay-related capabilities have been declared for an audio media stream AND the UC SCIP EI has idle modem relay resources available to support the modem relay call, then the UC SCIP EI MUST, in the sdp answer, declare its own modem relay-related capabilities for the audio media stream.

NOTE: A multiple appearance UC SCIP EI can only operate one session in secure mode (i.e., modem relay mode) at any given time. If a session on appearance 1 is currently operating in secure mode and the user wishes to transition the session on appearance 2 to secure mode, then the user must first transition the session on appearance 1 back to audio mode.

SIP-008200 Whenever a multiple appearance UC SCIP EI receives a SIP message with an sdp offer in which modem relay-related capabilities have been declared but the UC SCIP EI does not presently have idle modem relay resources to support a modem relay session, then the UC SCIP EI MUST only advertise audio capabilities and MUST NOT declare a modem relay capability in the sdp answer. This applies to ROUTINE calls and to precedence calls.

NOTE: To accept modem relay capabilities on one appearance, the user must either be operating in audio mode on the other appearance or the other appearance must be idle.

SIP-008210 As in the case of the sdp offer, the UC SCIP EI MUST use the same udp port number for the modem relay media (i.e., for SPRT and for SSE) as used for the corresponding audio media (i.e., for SPRT and for SSE).

SIP-008220 As in the case of the sdp offer, modem relay MUST be indicated as a latent capability in the sdp answer IAW RFC 3407, sdp Simple Capability Declaration, where:

SIP-008220.a The <media> parameter of the “cdsc” attribute MUST be assigned the value “audio.”

SIP-008220.b The <transport> parameter of the “cdsc” attribute MUST be assigned the value “udpsprt” to advertise SPRT.

SIP-008220.c The <fmt list> MUST match the dynamic payload type assigned in the sdp offer.

SIP-008220.d The payload type MUST be mapped to the modem relay payload format, v150mr, by including the “sprtmap” attribute in the RFC 3407 “cpar” attribute.

Example excerpt of sdp offer and answer:

Offer:

```
m=audio 49230 RTP/AVP 0 8
a=sqn: 0
a=cdsc: 1 audio udpsprt 100
a=cpar: a=sprtmap:100 v150mr/8000
```

Answer:

```
m=audio 32140 RTP/AVP 0
a=sqn: 0
a=cdsc: 1 audio udpsprt 100
a=cpar: a=sprtmap:100 v150mr/8000
```

SIP-008230 The UC SCIP EI MUST declare the SSE protocol in the sdp answer using the same dynamic RTP/AVP payload type assigned in the sdp offer where the <encoding name> parameter of the “rtpmap” attribute MUST be assigned the value “v150fw.”

Example excerpt of sdp offer and answer:

Offer:

```
m=audio 3456 RTP/AVP 0 96
a=rtpmap:96 v150fw/8000
```

Answer:

```
m=audio 4640 RTP/AVP 0 96
a=rtpmap:96 v150fw/8000
```

SIP-008240 If the sdp offer includes an “fmp” attribute line with supported events, then if the UC SCIP EI supports any of the events listed in the sdp offer the UC SCIP EI MUST include a “fmp” attribute in the sdp answer that includes the events that were listed in the sdp offer that are also supported by the UC SCIP EI.

SIP-008250 If event 1 Audio mode and event 3 Modem Relay mode are listed in the “fntp” attribute in the sdp offer, then events 1 and 3 MAY be listed, but are NOT required to be listed, in the sdp answer as they are implied by default, and event 2 VBD MUST NOT be present in the “fntp” attribute of the sdp offer or answer because it is NOT a valid media state for the purposes of this UCR document.

Example excerpt of sdp offer and answer including “fntp” attribute:

Offer:

```
m=audio 3456 RTP/AVP 0 96
a=rtpmap:96 v150fw/8000
a=fntp:96 4
```

Answer:

```
m=audio 4640 RTP/AVP 0 96
a=rtpmap:96 v150fw/8000
a=fntp:96 4
```

SIP-008260 This specification requires use of simple SSE repetition for SSE reliability, which is not declared in the sdp description and the UC SCIP EI MUST NOT declare support for the RFC 2198 RTP payload for redundant data in the sdp answer and MUST NOT declare support for the optional explicit acknowledgement procedure in the sdp answer.

SIP-008270 In the sdp answer, the UC SCIP EI MUST specify the following set of format-specific mandatory parameters for v150mr that are declared using the “fntp” attribute:

SIP-008270.a Modem relay type “mr” MUST be set to the value “1,” which represents U-MR.

SIP-008270.b Media gateway type “mg” MUST be set to “0” (“No Trans-compression”).

SIP-008270.c Call discrimination mode select, “CDSCselect” MUST be set to “1” (audio [RFC 2833]).

SIP-008270.c.1 If negotiation of call discrimination mode select fails for any reason, then it is assumed by the UC SCIP EI that “CDSCselect” is set to 1 (audio [RFC 2833]).

SIP-008270.d The parameter “mrmodes” identifies the V-series modulations supported in modem relay mode by the UC SCIP EI and for each of the following V-series modulations advertised in the sdp offer:

```
“1” (V.34 duplex)
“3” (V.32 bis/V.32)
```

the same V-series modulation MUST be included in the sdp answer.

SIP-008270.d.1 For any of the V-series modulations listed in Requirement SIP-008270d that are absent in the sdp offer, the UC SCIP EI MUST NOT include said absent V-series modulations in the sdp answer.

SIP-008270.d.2 If additional V-series modulations are present in the sdp offer and are supported by the UC SCIP EI, then the additional V series modulations MUST be added to the sdp answer.

SIP-008270.e The JM delay support procedure parameter “jmdelay” MUST be set to “no.”

SIP-008270.f The UC SCIP EI MUST specify the version of the V.150.x family of ITU-T Recommendations using the parameter “versn” where the value assumes a format of x.y where the “x” corresponds to the number after V.150 (currently x=1) and the “y” represents the version of the recommendation (currently y=1): versn=1.1.

SIP-008270.f.1 The value of the sdp “versn” parameter in the sdp answer MUST be equal to or lower than the value of the “versn” parameter in the sdp offer. For purposes of this version of the UCR, the value of the parameter “versn” is 1.1.

Example of v150mr mandatory parameters in sdp offer and answer:

Offer (from gateway):

```
m=audio 49232 RTP/AVP 0 8
a=sqn: 0
a=cdsc: 1 audio udpsprt 100
a=cpar: a=sprtmap:100 v150mr/8000
a=cpar :a=fmtp:100 mr=1; mg=1; CDSCselect=1; mrmodes=1,3,13,14,16,17;
jmdelay=no; versn=1.1
```

Answer (from UC SCIP EI):

```
m=audio 33310 RTP/AVP 0
a=sqn: 0
a=cdsc: 1 audio udpsprt 100
a=cpar: a=sprtmap:100 v150mr/8000
a=cpar :a=fmtp:100 mr=1; mg=0; CDSCselect=1; mrmodes=1,3; jmdelay=no;
versn=1.1
```

SIP-008280 The UC SCIP EI MUST indicate support for, at a minimum, the following RFC 2833 events: ANS (32), /ANS (33), ANSam (34), and/ANSam (35).

Example:

```
m=audio 37416 RTP/AVP 0 8 97
a=rtpmap:97 telephone-event/8000
a=fmtp:97 32-35
```

SIP-008290 When the UC SCIP EI receives an sdp offer from a Modem Relay-Preferred endpoint (i.e., the audio media stream in the sdp offer advertises the “NoAudio” payload as the only payload type), then the UC SCIP EI MUST respond in the sdp answer by accepting the “NoAudio” payload type.

Example:

‘NoAudio’ sdp offer:

```
m=audio 12346 RTP/AVP 99
a=rtpmap:99 NoAudio/8000
```

‘NoAudio’ sdp answer:

```
m=audio 24560 RTP/AVP 99
a=rtpmap:99 NoAudio/8000
```

SIP-008290.a Whenever the “NoAudio” payload type has been negotiated for a media stream, then the UC SCIP EI MUST cease transmission of voice traffic over the given media stream.

SIP-008300 Whenever the UC SCIP EI receives an sdp offer in which one or more audio payload types supported by the UC SCIP EI are advertised in addition to the “NoAudio” payload type, then the UC SCIP EI MUST respond in the sdp answer by accepting one of the supported audio payload types.

SIP-008310 If the sdp offer includes the “sprtparm” attribute, then the sdp answer MUST include the “sprtparm” attribute in the sdp answer where each parameter value advertised in the sdp answer MUST be less than or equal to the corresponding parameter value in the sdp offer AND, in all cases, the parameter value MUST be within the value range specified in [Table 11.21](#), ITU Recommendation V.150.1, Table E.2.

SIP-008320 If the sdp offer received by the UC SCIP EI does not include the “sprtparm” attribute the sdp answer MUST NOT include the “sprtparm” attribute because the UC SCIP EI is required to be capable of supporting the default values for maximum payload size for SPRT channels 0, 2, and 3 and the maximum window size for SPRT channel 2.

SIP-008320.a If negotiation of the optional SPRT protocol parameters fails for any reason, then the default values MUST be used by the local UC SCIP EI and by the remote gateway or UC SCIP EI.

Basic Example of SDP Offer Generated by UC SCIP EI that Advertises Modem Relay Capabilities:

```
v=0
o=- 25678 753849 IN IP4 128.96.128.1
s=
c=IN IP4 128.96.128.1
t=0 0
m=audio 49230 RTP/AVP 0 8 97 98 111
a=rtpmap:97 telephone-event/8000
a=fmtp:97 32,33,34,35
a=rtpmap:98 v150fw/8000
a=rtpmap:111 NoAudio/8000
a=sn: 0
a=cdsc: 1 audio udpsprt 100
a=cpar: a=sprtmap:100 v150mr/8000
a=cpar :a=fmtp:98 mr=1; mg=0; CDSCselect=1; mrmodes=1,3; jmdelay=no;
versn=1.1
```

Basic Example of SDP Answer Generated by UC SCIP EI that Advertises Modem Relay Capabilities:

```
v=0
o=- 14481 30303 IN IP4 132.44.17.220
s=
c=IN IP4 132.44.17.220
t=0 0
m=audio 49230 RTP/AVP 0 97 98
a=rtpmap:97 telephone-event/8000
a=fmtp:97 32,33,34,35
a=rtpmap:98 v150fw/8000
a=sn: 0
a=cdsc: 1 audio udpsprt 100
a=cpar: a=sprtmap:100 v150mr/8000
a=cpar :a=fmtp:98 mr=1; mg=0; CDSCselect=1; mrmodes=1,3; jmdelay=no;
versn=1.1
```

SECTION 12

TDM – SIP TRANSLATION REQUIREMENTS FOR INTER-WORKING AS-SIP SIGNALING APPLIANCES

12.1 INTRODUCTION

The UC SBU design has been evolving over time and the following paragraphs detailing the requirements for interworking AS-SIP signaling and TDM signaling are crafted to reflect that evolution. At the outset, the focus for AS-SIP-TDM signaling interworking was the SS⁹⁴. It is now understood and the following paragraphs reflect that the AS-SIP-TDM interworking may occur at the SS or at the SC.

The detailed signal interworking requirements in the following paragraphs describe translation between AS-SIP and SS7 ISUP. It is recognized that the TDM signaling to be interworked at the SS may take the form of SS7 ISUP and/or ISDN Q.931, and that TDM signaling at the SC will probably take the form of ISDN Q.931 messages.⁹⁵ The most comprehensive standards document covering SIP-TDM signaling interworking is ITU-T Recommendation Q.1912.5, which defines the requirements for SIP-ISUP translation and encapsulation. Reliance has been placed on Recommendation Q.1912.5 and to a lesser extent RFC 3398 as the base documents for defining signaling interoperability between SIP and TDM. As the interworking between SS7 ISUP and ISDN Q.931 is well understood and has been practiced in TDM switches for an extended period, the SIP-SS7 translation requirements found in these sections are also deemed to provide a sufficient basis for the interoperable interworking of SIP with ISDN Q.931.

NOTE: This specification uses SIP translation for converting between ISUP signaling and AS-SIP signaling but does not use SIP encapsulation of ISUP.

The signaling mediation requirements levied on the interworking AS-SIP signaling appliances are best organized and understood in the context of the role of the originating TDM/IP SG and the terminating IP/TDM signaling gateway in each of the three call signaling path types described in the following paragraphs (i.e., TDM-to-TDM calls over IP backbone, TDM-to-IP calls and IP-to-TDM calls).

12.1.1 TDM-to-TDM Calls Over IP Backbone

[Figure 12.1-1](#), TDM-to-TDM Bridging over an IP Backbone, depicts the basic signaling elements in a TDM-to-TDM call flow bridging over an IP backbone wherein the SS on the left assumes the role of an originating TDM/IP SG and the SS on the right assumes the role of a terminating IP/TDM SG. Each interworking gateway conducts translation between SIP and the

⁹⁴ Identified in earlier versions as the Multifunction Softswitch or SIP-T(AS) signaling appliance.

⁹⁵ For completeness, note that the interworking could also occur between AS-SIP and a channel-associated signaling trunk.

corresponding TDM signaling. Refer to [Table 12.1-1](#), Reference Case #1a – TDM-to-TDM Bridging over an IP Backbone, for Reference Case #1a.

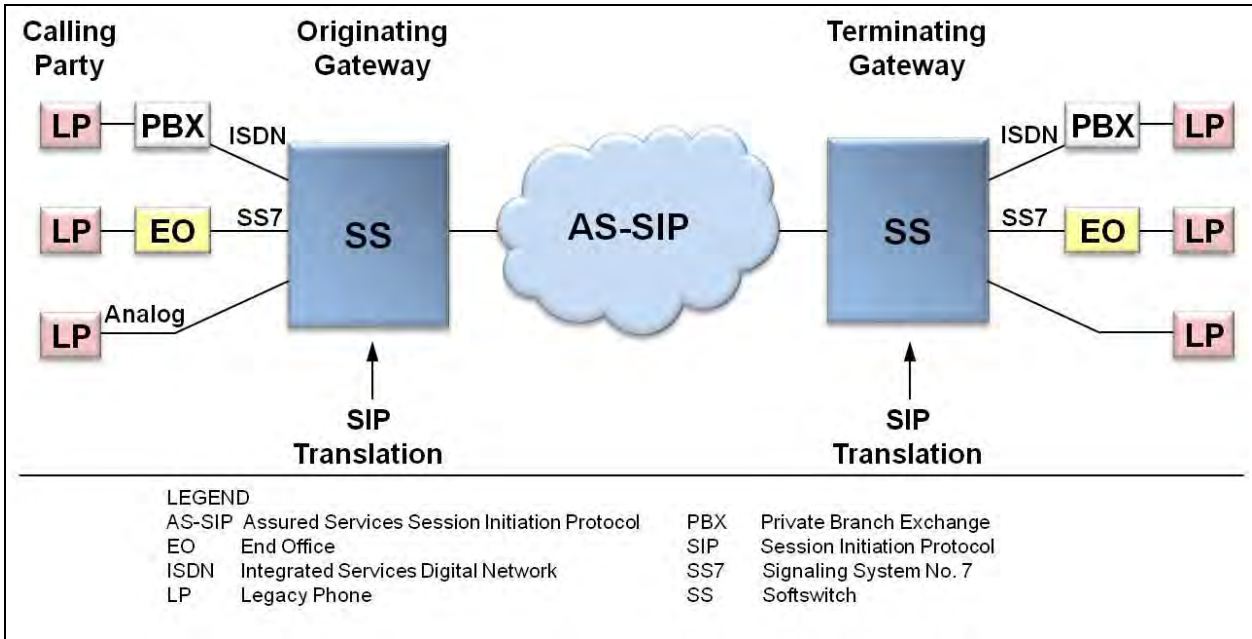

Figure 12.1-1. TDM-to-TDM Bridging Over an IP Backbone

Table 12.1-1. Reference Case #1a – TDM-to-TDM Bridging Over an IP Backbone

1A	Legacy phone	PBX	ISDN	SS	AS-SIP	SS	ISDN	PBX	Legacy phone
1B	Legacy phone	PBX	ISDN	SS	AS-SIP	SS	SS7	EO	Legacy phone
1C	Legacy phone	PBX	ISDN	SS	AS-SIP	SS	Analog		Legacy phone
1D	Legacy phone	EO	SS7	SS	AS-SIP	SS	ISDN	PBX	Legacy phone
1E	Legacy phone	EO	SS7	SS	AS-SIP	SS	SS7	EO	Legacy phone
1F	Legacy phone	EO	SS7	SS	AS-SIP	SS	Analog		Legacy phone
1G	Legacy phone		Analog	SS	AS-SIP	SS	ISDN	PBX	Legacy phone
1H	Legacy phone		Analog	SS	AS-SIP	SS	SS7	EO	Legacy phone
1I	Legacy phone		Analog	SS	AS-SIP	SS	Analog		Legacy phone

[Figure 12.1-2](#), TDM-to-TDM Bridging from Enclave-to-Enclave, depicts the basic signaling elements in a TDM-to-TDM call flow bridging from enclave to enclave wherein the SC on the

left assumes the role of an originating TDM/IP SG and the SC on the right assumes the role of a terminating IP/TDM SG. In [Figure 12.1-2](#), the TDM connectivity between the enclave and the core has been removed and the only connectivity from the enclave to the core consists of IP connectivity. Each interworking gateway (SC) conducts translation between SIP and the corresponding TDM signaling (e.g., ISDN Q.931). Refer to [Table 12.1-2](#), Reference Case #1b – TDM-to-TDM Bridging from Enclave-to-Enclave, for Reference Case #1b.

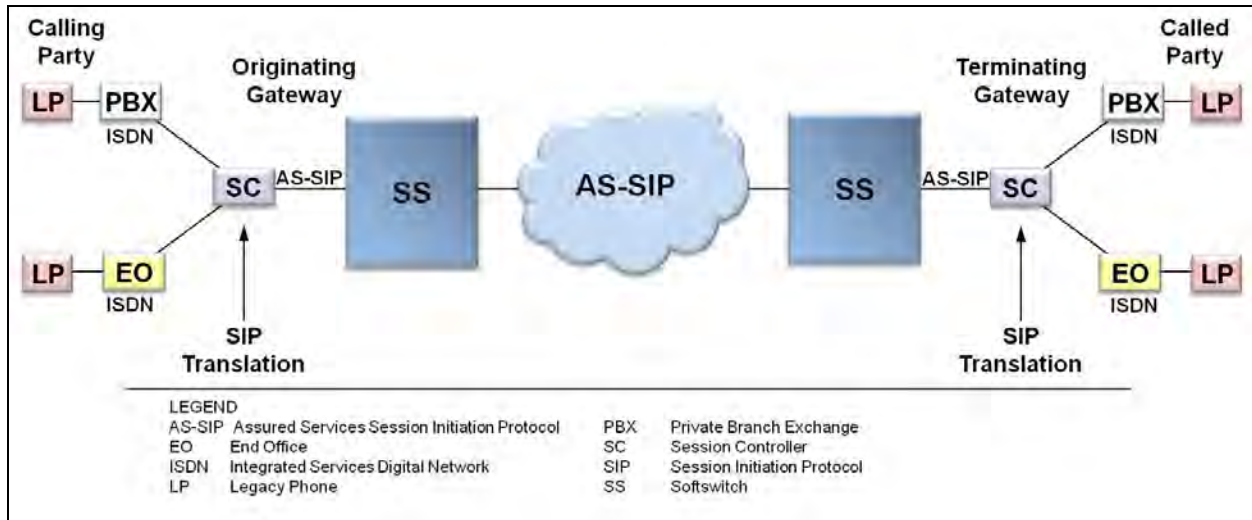

Figure 12.1-2. TDM-to-TDM Bridging From Enclave-to-Enclave

Table 12.1-2. Reference Case #1b – TDM-to-TDM Bridging From Enclave-to-Enclave

1J	Legacy phone	PBX	ISDN	SC	AS-SIP	SS	AS-SIP	SS	AS-SIP	SC	ISDN	PBX	Legacy phone
1K	Legacy phone	PBX	ISDN	SC	AS-SIP	SS	AS-SIP	SS	AS-SIP	SC	ISDN	EO	Legacy phone
1L	Legacy phone	EO	ISDN	SC	AS-SIP	SS	AS-SIP	SS	AS-SIP	SC	ISDN	PBX	Legacy phone
1M	Legacy phone	EO	ISDN	SC	AS-SIP	SS	AS-SIP	SS	AS-SIP	SC	ISDN	EO	Legacy phone

[Figure 12.1-3](#), TDM-to-TDM Bridging from SS-to-SC, depicts the basic signaling elements in a TDM-to-TDM call flow bridging over an IP backbone wherein the SS on the left assumes the role of an originating TDM/IP SG and the SC on the right assumes the role of a terminating IP/TDM SG. Each interworking gateway conducts translation between SIP and the corresponding TDM signaling. Refer to [Table 12.1-3](#), Reference Case #1c – TDM-to-TDM Bridging from Softswitch-to-SC, for Reference Case #1c.

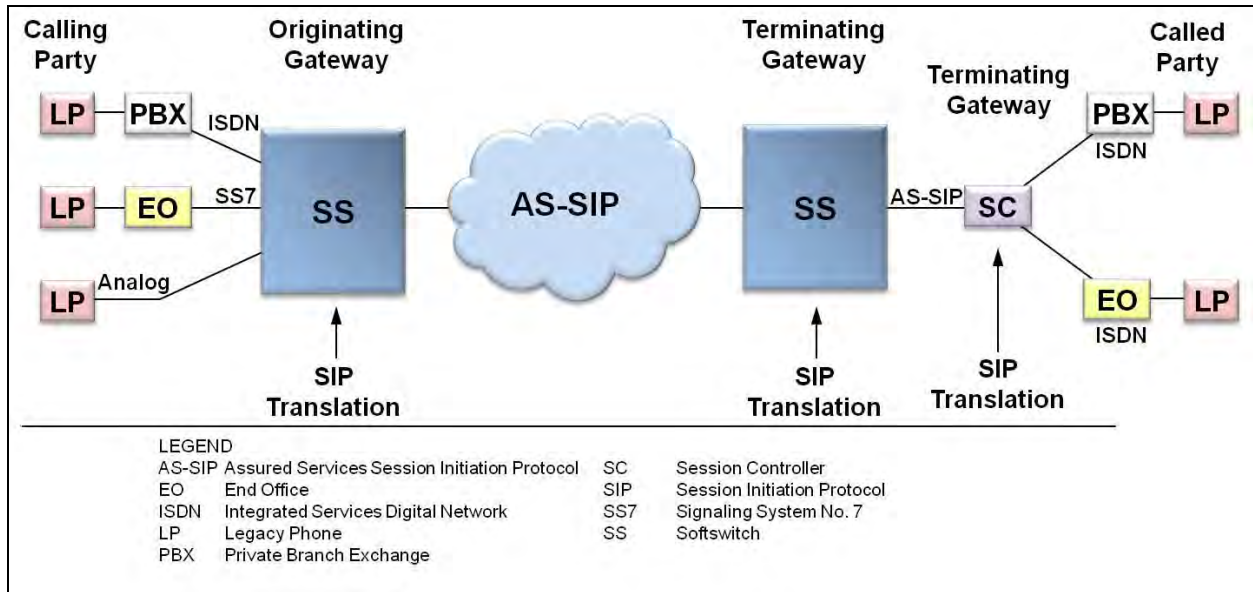

Figure 12.1-3. TDM-to-TDM Bridging From Softswitch-to-SC

Table 12.1-3. Reference Case #1c – TDM-to-TDM Bridging From Softswitch-to-SC

1N	Legacy phone	PBX	ISDN	SS	AS-SIP	SS	AS-SIP	SC	ISDN	PBX	Legacy phone
1O	Legacy phone	PBX	ISDN	SS	AS-SIP	SS	AS-SIP	SC	ISDN	EO	Legacy phone
1P	Legacy phone	EO	SS7	SS	AS-SIP	SS	AS-SIP	SC	ISDN	PBX	Legacy phone
1Q	Legacy phone	EO	SS7	SS	AS-SIP	SS	AS-SIP	SC	ISDN	EO	Legacy phone
1R	Legacy phone		Analog	SS	AS-SIP	SS	AS-SIP	SC	ISDN	PBX	Legacy phone
1S	Legacy phone		Analog	SS	AS-SIP	SS	AS-SIP	SC	ISDN	EO	Legacy phone

Figure 12.1-4, TDM-to-TDM Bridging from SC-to-Softswitch, depicts the basic signaling elements in a TDM-to-TDM call flow bridging over an IP backbone wherein the SC on the left assumes the role of an originating TDM/IP SG and the SS on the right assumes the role of a terminating IP/TDM SG. Each inter-working gateway conducts translation between SIP and the corresponding TDM signaling. Refer to Table 12.1-4 for Reference Case #1d.

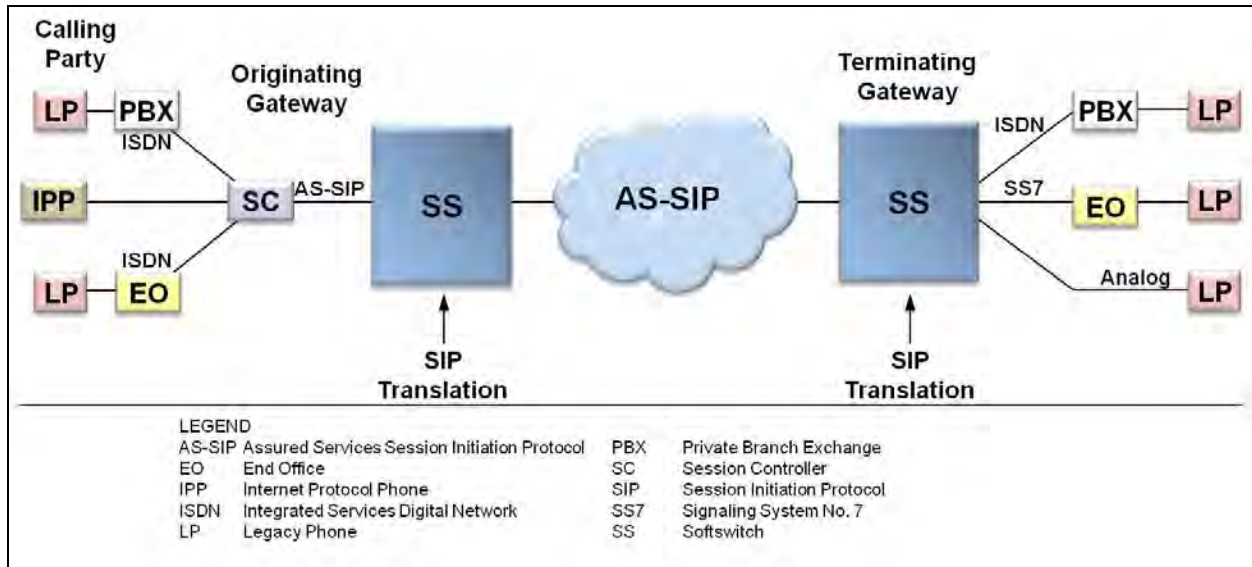

Figure 12.1-4. TDM-to-TDM Bridging From SC-to-Softswitch

Table 12.1-4. Reference Case #1d – TDM-to-TDM Bridging From SC-to-Softswitch

1T	Legacy phone	PBX	ISDN	SC	AS-SIP	SS	AS-SIP	SS	ISDN	PBX	Legacy phone
1U	Legacy phone	PBX	ISDN	SC	AS-SIP	SS	AS-SIP	SS	SS7	EO	Legacy phone
1V	Legacy phone	PBX	ISDN	SC	AS-SIP	SS	AS-SIP	SS		Analog	Legacy phone
1W	Legacy phone	EO	ISDN	SC	AS-SIP	SS	AS-SIP	SS	ISDN	PBX	Legacy phone
1X	Legacy phone	EO	ISDN	SC	AS-SIP	SS	AS-SIP	SS	SS7	EO	Legacy phone
1Y	Legacy phone	EO	ISDN	SC	AS-SIP	SS	AS-SIP	SS		Analog	Legacy phone

12.1.2 TDM-to-IP Calls Over an IP Backbone

[Figure 12.1-5](#), TDM-to-IP Call over an IP Backbone, depicts the basic signaling elements in a TDM-to-IP call flow in which the SS (shown to the left of the IP backbone) assumes the role of an originating TDM/IP SG. The originating TDM/IP SG will conduct translation between ISUP and AS-SIP.

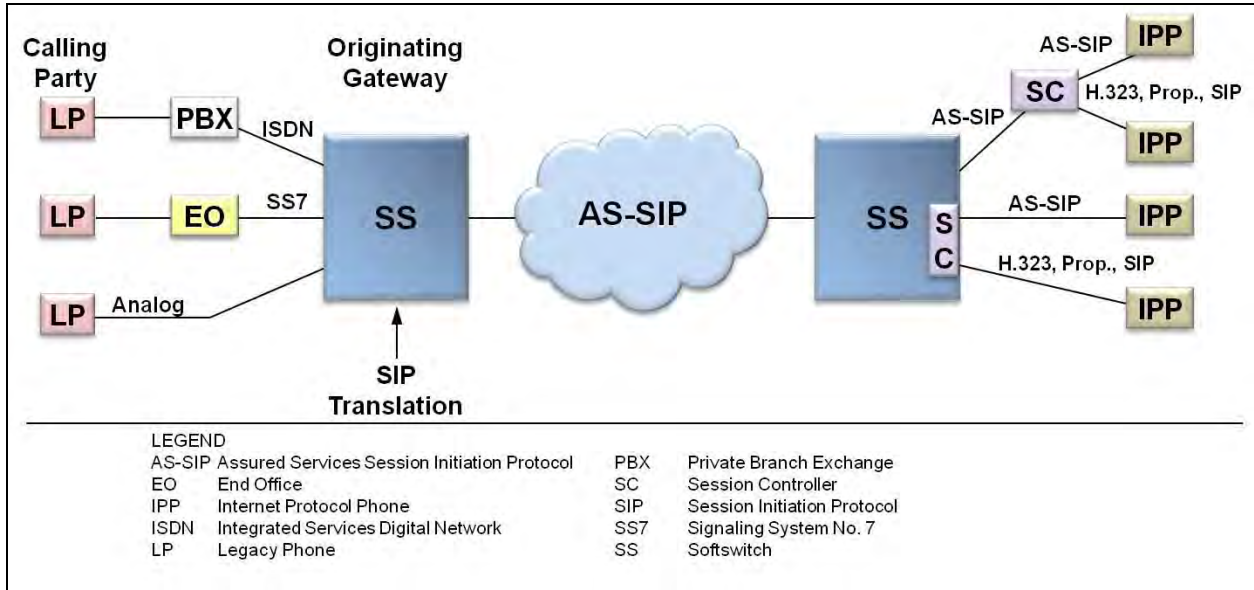

Figure 12.1-5. TDM-to-IP Call Over an IP Backbone

The SS to the right of the IP backbone forwards the AS-SIP message to an SC or the SC component of the SS sends an AS-SIP, SIP, H.323, or proprietary signaling message to a directly served IP EI. Refer to [Table 12.1-5](#), Reference Case #2a – TDM-to-IP Call over an IP Backbone, for the set of end-to-end TDM-to-IP signaling paths across SCs and SSs over this topology.

Table 12.1-5. Reference Case #2a – TDM-to-IP Call Over an IP Backbone

2A	Legacy phone	PBX	ISDN	SS	AS-SIP	SS	AS-SIP	SC	AS-SIP	IP phone
2B	Legacy phone	PBX	ISDN	SS	AS-SIP	SS	AS-SIP	SC	H.323, Prop, SIP	IP phone
2C	Legacy phone	PBX	ISDN	SS	AS-SIP	←SS SC comp.→	AS-SIP			IP phone
2D	Legacy phone	PBX	ISDN	SS	AS-SIP	←SS SC comp.→	H.323, Prop, SIP			IP phone
2E	Legacy phone	EO	CCS7	SS	AS-SIP	SS	AS-SIP	SC	AS-SIP	IP phone
2F	Legacy phone	EO	CCS7	SS	AS-SIP	SS	AS-SIP	SC	H.323, Prop, SIP	IP phone
2G	Legacy phone	EO	CCS7	SS	AS-SIP	←SS SC comp.→	AS-SIP			IP phone
2H	Legacy phone	EO	CCS7	SS	AS-SIP	←SS SC comp.→	H.323, Prop, SIP			IP phone
2I	Legacy phone		Analog	SS	AS-SIP	SS	AS-SIP	SC	AS-SIP	IP phone
2J	Legacy phone		Analog	SS	AS-SIP	SS	AS-SIP	SC	H.323, Prop, SIP	IP phone
2K	Legacy phone		Analog	SS	AS-SIP	←SS SC comp.→	AS-SIP			IP phone

2L	Legacy phone		Analog	SS	AS-SIP	←SS SC comp. →	H.323, Prop, SIP			IP phone
----	--------------	--	--------	----	--------	-------------------	---------------------	--	--	----------

Figure 12.1-6 depicts the basic signaling elements in a TDM-to-IP call flow in which the SC (shown to the left of the IP backbone) assumes the role of an originating TDM/IP Gateway. The originating TDM/IP Gateway will conduct translation between ISUP and AS-SIP.

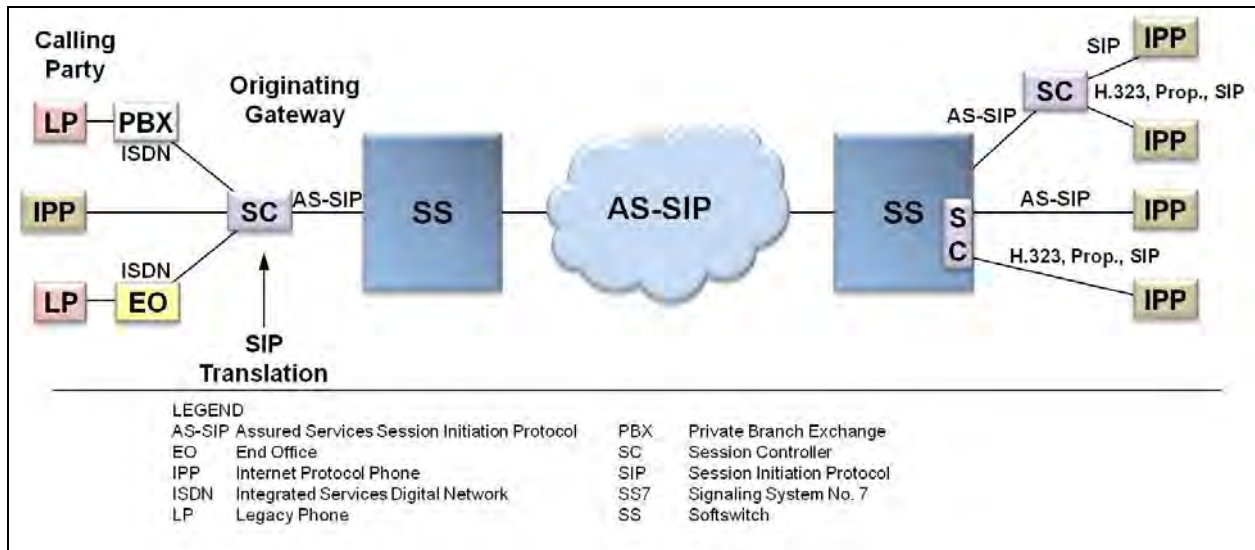

Figure 12.1-6. TDM-to-IP Call Translated at Originating Enclave

The SS to the right of the IP backbone either sends an AS-SIP, SIP, H.323, or proprietary signaling message to a directly served IP EI or forwards the AS-SIP message to the SC which in turn sends an AS-SIP, SIP, H.323, or proprietary signaling message to a directly served IP EI. Refer to Table 12.1-6 for the set of end-to-end TDM-to-IP signaling paths across SCs and SSs over this topology.

Table 12.1-6. Reference Case #2b – TDM-to-IP Call Translated at Originating Enclave

2M	Legacy phone	PBX	ISDN	SS	AS-SIP	SS	AS-SIP	SC	AS-SIP	IP phone
2N	Legacy phone	PBX	ISDN	SS	AS-SIP	SS	AS-SIP	SC	H.323, Prop, SIP	IP phone
2O	Legacy phone	PBX	ISDN	SS	AS-SIP	←SS SC comp. →	AS-SIP			IP phone
2P	Legacy phone	PBX	ISDN	SS	AS-SIP	←SS SC comp. →	H.323, Prop, SIP			IP phone
2Q	Legacy phone	EO	ISDN	SS	AS-SIP	SS	AS-SIP	SC	AS-SIP	IP phone
2R	Legacy phone	EO	ISDN	SS	AS-SIP	SS	AS-SIP	SC	H.323, Prop, SIP	IP phone
2S	Legacy phone	EO	ISDN	SS	AS-SIP	←SS SC comp. →	AS-SIP			IP phone
2T	Legacy phone	EO	ISDN	SS	AS-SIP	←SS SC comp. →	H.323, Prop, SIP			IP phone

12.1.3 5.3.4.14.1.3 IP-to-TDM Calls Over an IP Backbone

Figure 12.1-7, IP-to-TDM Call over an IP Backbone, depicts the basic signaling elements in an IP-to-TDM call flow in which the SS (shown to the right of the IP backbone) assumes the role of a terminating IP/TDM Gateway. The terminating IP/TDM Gateway will conduct translation between AS-SIP and the corresponding TDM signaling.

The SS to the left of the IP backbone operates as a SIP B2BUA when forwarding an AS-SIP message from a served SC and the SC component of the SS operates as either a B2BUA or call stateful SIP proxy server when serving an AS-SIP endpoint. Refer to Table 12.1-7, Reference Case #3a – IP-to-TDM Call over an IP Backbone, for the set of end-to-end IP-to-TDM signaling paths across SCs and SSs over this topology.

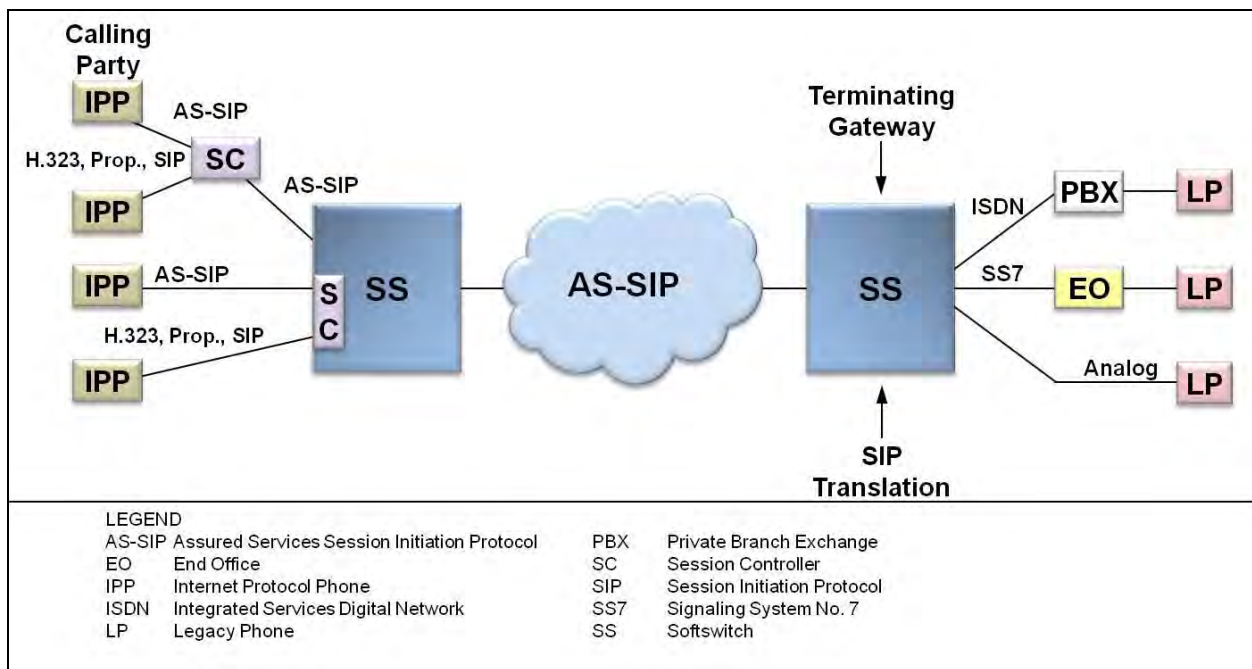

Figure 12.1-7. IP-to-TDM Call Over an IP Backbone

Table 12.1-7. Reference Case #3a – IP-to-TDM Call Over an IP Backbone

3A	IP phone	AS-SIP	SC	AS-SIP	SS	AS-SIP	SS	ISDN	PBX	Legacy phone
3B	IP phone	AS-SIP	SC	AS-SIP	SS	AS-SIP	SS	CCS7	EO	Legacy phone
3C	IP phone	AS-SIP	SC	AS-SIP	SS	AS-SIP	SS	Analog		Legacy phone
3D	IP phone	H.323, Prop, SIP	SC	AS-SIP	SS	AS-SIP	SS	ISDN	PBX	Legacy phone
3E	IP phone	H.323, Prop, SIP	SC	AS-SIP	SS	AS-SIP	SS	CCS7	EO	Legacy phone
3F	IP phone	H.323, Prop, SIP	SC	AS-SIP	SS	AS-SIP	SS	Analog		Legacy phone
3G	IP phone	AS-SIP			←SC comp SS→	AS-SIP	SS	ISDN	PBX	Legacy phone

3H	IP phone	AS-SIP			←SC comp SS→	AS-SIP	SS	CCS7	EO	Legacy phone
3I	IP phone	AS-SIP			←SC comp SS→	AS-SIP	SS	Analog		Legacy phone
3J	IP phone	H.323, Prop, SIP			←SC comp SS→	AS-SIP	SS	ISDN	PBX	Legacy phone
3K	IP phone	H.323, Prop, SIP			←SC comp SS→	AS-SIP	SS	CCS7	EO	Legacy phone
3L	IP phone	H.323, Prop, SIP			←SC comp SS→	AS-SIP	SS	Analog		Legacy phone

Figure 12.1-8, IP-to-TDM Call Translated at Destination Enclave, depicts the basic signaling elements in an IP-to-TDM call flow in which the SC (shown to the right of the IP backbone) assumes the role of a terminating IP/TDM Gateway. The terminating IP/TDM Gateway will conduct translation between AS-SIP and the corresponding TDM signaling.

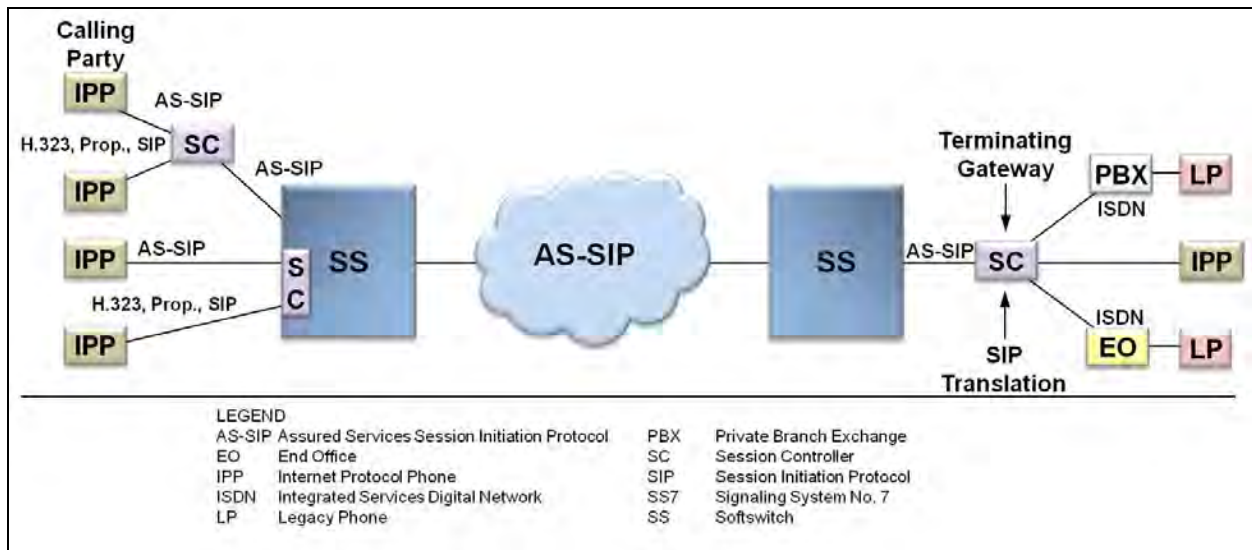

Figure 12.1-8. IP-to-TDM Call Translated at Destination Enclave

The SS to the left of the IP backbone operates as a SIP B2BUA when forwarding an AS-SIP message from a served SC and the SC component of the SS operates as either a B2BUA or call stateful SIP proxy server when serving an AS-SIP endpoint. Refer to Table 12.1-8, Reference Case #3b – IP-to-TDM Call Translated at Destination Enclave, for the set of end-to-end IP-to-TDM signaling paths across SCs and SSs over this topology.

Table 12.1-8. Reference Case #3b – IP-to-TDM Call Translated at Destination Enclave

3M	IP phone	AS-SIP	SC	AS-SIP	SS	AS-SIP	SS	AS-SIP	SC	ISDN	PBX	Legacy phone
3M	IP phone	AS-SIP	SC	AS-SIP	SS	AS-SIP	SS	AS-SIP	SC	ISDN	EO	Legacy phone
3O	IP phone	H.323, Prop, SIP	SC	AS-SIP	SS	AS-SIP	SS	AS-SIP	SC	ISDN	PBX	Legacy phone

3P	IP phone	H.323, Prop, SIP	SC	AS-SIP	SS	AS-SIP	SS	AS-SIP	SC	ISDN	EO	Legacy phone
3Q	IP phone	AS-SIP			←SC comp SS→	AS-SIP	SS	AS-SIP	SC	ISDN	PBX	Legacy phone
3R	IP phone	AS-SIP			←SC comp SS→	AS-SIP	SS	AS-SIP	SC	ISDN	EO	Legacy phone
3S	IP phone	H.323, Prop, SIP			←SC comp SS→	AS-SIP	SS	AS-SIP	SC	ISDN	PBX	Legacy phone
3T	IP phone	H.323, Prop, SIP			←SC comp SS→	AS-SIP	SS	AS-SIP	SC	ISDN	EO	Legacy phone

12.2 SUMMARY DESCRIPTION OF THE THREE CALL TYPES

12.2.1 TDM Bridging

Both EIs are TDM, but the call traverses an IP network.

Bearer: TDM to IP to TDM
Signaling: ISUP to AS-SIP to ISUP

Originating Gateway (O-IWU)

Receives IAM from SS7 network, creates INVITE, maps between ISUP IAM parameters and SIP headers, and sends INVITE onto the IP network.

Receives AS-SIP messages, creates corresponding ISUP messages, translates SIP headers of AS-SIP messages to ISUP parameters, and sends the ISUP message onto the SS7 network.

Terminating Gateway (I-IWU)

Receives INVITE, creates IAM, translates SIP headers of INVITE to IAM parameter fields, processes IAM IAW standard ISUP procedures, and sends the IAM onto the SS7 network.

Receives ISUP messages from the SS7 network (e.g., ACM, ANM, CPG, CON, REL, RLC) that are sent in the backward direction and associated with a previously received INVITE, creates the appropriate AS-SIP messages, maps the necessary info from the ISUP message to the SIP headers, and sends the AS-SIP message onto the IP network.

12.2.2 TDM-to-IP Call

The originator is a TDM EI, and the destination is an IP EI.

Bearer: TDM to IP, IP to TDM
Signaling: ISUP to AS-SIP

Originating Gateway (O-IWU)

The originating gateway receives an IAM from the SS7 network, creates an INVITE, maps between ISUP IAM parameters and SIP headers, and sends the INVITE onto the IP network.

The originating gateway receives AS-SIP requests and responses including 1xx, 200 (OK), 202 (Accepted), 3xx, 4xx, 5xx, 6xx, BYE, and so on, maps the AS-SIP request/response to an ISUP message, and sends the ISUP message onto the SS7 network.

12.2.3 IP-to-TDM Call

The originator is an IP EI, and the destination is a TDM EI.

Bearer: IP to TDM, TDM to IP
Signaling: AS-SIP to ISUP

Terminating Gateway (I-IWU)

The terminating gateway receives an INVITE, maps INVITE header fields to IAM parameters, and sends an IAM onto the SS7 network.

The terminating gateway receives ISUP messages from the SS7 network (e.g., ACM, ANM, CPG, CON, REL, RLC), maps ISUP messages and fields to AS-SIP messages and header fields, and sends AS-SIP messages onto IP network.

12.3 SIP URI AND MAPPING OF TELEPHONY NUMBER INTO SIP URI

SIP-008330 Any telephone number translated by an interworking AS-SIP signaling appliance from ISUP (or Q.931) parameters to fields in SIP headers **MUST** be represented as a SIP URI per [Section 4.6](#), SIP URI and Mapping of Telephony Number Into SIP URI.

SIP-008340 When an interworking AS-SIP signaling appliance receives a TDM call request to be translated into an AS-SIP INVITE in which the dialed number is from the DSN worldwide numbering plan, then the AS-SIP signaling appliance **MUST** ensure that the userinfo part of the SIP URI in the Request-URI field of the INVITE is the complete 10-digit DSN number.

SIP-008340.a In the event the dialed number in the ISUP (or Q.931) parameter is a DSN number having fewer than the full 10 digits, then the interworking AS-SIP signaling appliance **MUST** prepend the three area code digits (KXX) of the AS-SIP signaling appliance's local area code and any other missing digits to create the full 10-digit DSN number.

SIP-008340.b The SIP URI **MUST** have a "user=phone" field appended to the URI.

SIP-008340.c The 10-digit DSN number **MAY** be followed by a phone-context descriptor consisting of a domain name (per RFC 3966).

SIP-008350 When an interworking AS-SIP signaling appliance receives a TDM call request to be translated into an AS-SIP INVITE in which a telephone number translated by the interworking AS-SIP signaling appliance is a PSTN number, then the userinfo part of the SIP URI MUST be represented in global E.164 notation and MUST have a “user=phone” field appended to the URI.

SIP-008350.a When the numbering plan indicator of the called party number has the value signifying ISDN Numbering Plan (Recommendation E.164) and the number is not an emergency number or directory assistance number, or other service code, then:

SIP-008350.a.1 If the nature of address indicator is set to national significant number, then the originating gateway prepends the country code and generates an E.164 number that is placed after the “+” sign in the userinfo part of the SIP URI.

SIP-008350.a.2 If the nature of address indicator is set to subscriber (i.e., local) number, then the originating gateway prepends the country code, area code, city code (if necessary) required to generate an E.164 number that is placed after the “+” sign in the userinfo part of the SIP URI.

NOTE: If for some reason there is insufficient information to generate the E.164 number, then the SIP URI will reject the call request. The cause code value for the Release message is 28 Incomplete Address.

12.4 GENERAL REQUIREMENTS FOR INTERWORKING AS-SIP SIGNALING APPLIANCES

(The UCR mandates the use of ISUP to SIP translation and prohibits the use of ISUP encapsulation which is described in ITU-T Recommendation Q.1912.5 as Profile C [SIP-I].)

SIP-008360 (ITU ISUP only) (Applies to TDM Bridging call type and TDM-IP call type) When an interworking AS-SIP signaling appliance receives an ISUP message having the optional Forward Call Indicators (FCIs) parameter with the IAM segmentation indicator set to “Additional information being sent by unsolicited information message,” or the optional Backward Call Indicator (BCI) parameter with the IAM segmentation indicator set to “Additional information has been received and added to IAM,” then the interworking AS-SIP signaling appliance MUST wait for the segmentation message and translate the ISUP message to the appropriate AS-SIP message.

12.5 ISUP VERSIONS

This specification describes the translation and processing applicable to the interoperation of AS-SIP and the ITU-T Recommendation Q.761-4 (1992) version of ISUP.

This specification also covers the translation and processing applicable to the interoperation of AS-SIP and ANSI ISUP (including ANSI T1.113-2000, Telcordia GR-317, GR-317-CORE, and

GR-394-CORE). Differences between the function of the ANSI ISUP and the ITU T ISUP will be identified in this specification.

12.5.1 Encapsulation of ISUP Messages in AS-SIP Requests/Responses

All ISUP encapsulation requirements have been removed.

12.5.2 De-Encapsulation of ISUP Messages From AS-SIP Requests/Responses

All ISUP de-encapsulation requirements have been removed.

12.5.3 ISUP Messages That Are Never Encapsulated

ISUP messages are never encapsulated.

12.5.4 Tones

SIP-008370 Media paths controlled by the interworking AS-SIP signaling appliance **MUST** support the transmission and receipt of DTMF-related named events as set forth in RFC 4733.

SIP-008380 Media paths controlled by the interworking AS-SIP signaling appliance **MAY** support the transmission and receipt of standard subscriber line tone events set forth in RFC 2833 (deprecated in RFC 4733).

SIP-008390 When a DTMF digit is transmitted over a media path where the signaling is controlled by an interworking AS-SIP signaling appliance (e.g., SS or SC controlling an MG), then:

SIP-008390.a If the audio codec is G.711, it is **STRONGLY RECOMMENDED** that the DTMF-related named events of RFC 4733, Section 3.2 be used.

SIP-008390.b If the audio codec is not G.711, then the DTMF-related named events of RFC 4733, Section 3.2 **MUST** be used.

NOTE: IP EIs that exchange bearer traffic with an MG controlled by an interworking AS-SIP signaling appliance either will need to support the transmission and receipt of DTMF-related named events as set forth in RFC 4733, or will require an intermediary device in the bearer plane to perform a conversion between the DTMF tones and the RFC 4733, Section 3.2 DTMF-related named events.

12.6 TRANSLATION REQUIREMENTS FOR AN INTER-WORKING AS-SIP SIGNALING APPLIANCE OPERATING AS AN ORIGINATING GATEWAY

12.6.1 General Requirements (Originating Gateway)

SIP-008400 Originating gateways facing ISUP networks in which overlap dialing is used will implement timers to ensure that all digits have been collected before an INVITE is transmitted to the IP network (RFC 3398).

SIP-008410 Originating gateways **MUST** wait until a complete ISUP message is received before sending any corresponding INVITE (RFC 3398).

12.6.2 TDM Bridging Call Flow and TDM-IP Call Flow Requirements (Originating Gateway)

12.6.2.1 Originating Gateway Sends AS-SIP INVITE

SIP-008420 As specified in [Section 12.6.1](#), General Requirements (Originating Gateway), all the digits **MUST** be collected (i.e., a complete address) before the originating gateway is permitted to create the INVITE (i.e., en bloc addressing) (ITU-T Recommendation Q.1912.5, Section 7.1).

SIP-008430 When the originating gateway receives an IAM and the originating gateway is **NOT** using precondition signaling for the AS-SIP call request:

SIP-008430.a If the continuity check indicator in the “Nature of Connection Indicators” parameter in the IAM had been set to “continuity check not required,” the originating gateway creates an AS-SIP INVITE, promptly sends the INVITE onto the IP network, sets the SIP T1 timer, and sets the ISUP T11 timer.

SIP-008430.b If the continuity check indicator in the “Nature of Connection Indicators” parameter in the IAM had been set to “continuity check required on this circuit” or “continuity check performed on previous circuit,” the originating gateway delays sending the INVITE until it receives a Continuity message with the “Continuity Indicators” parameter set to “continuity check successful,” which **MUST** be received before the expiration of the ISUP T8 timer. If the ISUP T8 timer expires before receiving the Continuity message, then the originating gateway does **NOT** send the INVITE.

SIP-008440 When the originating gateway receives an IAM and the originating gateway is using precondition signaling for the AS-SIP call request:

SIP-008440.a The originating gateway creates an AS-SIP INVITE with precondition fields in the SDP offer, sends the AS-SIP INVITE onto the IP network, sets the SIP T1 timer, and sets the ISUP T11 timer.

SIP-008440.b If the continuity check indicator in the “Nature of Connection Indicators” parameter in the IAM had been set to “continuity check not required,” then when the requested preconditions have been met in the IP network the originating gateway sends the SDP offer or answer confirming that the precondition has been met.

SIP-008440.c If the continuity check indicator in the “Nature of Connection Indicators” parameter in the IAM had been set to “continuity check required on this circuit” or “continuity check performed on previous circuit,” then the originating gateway only sends the SDP offer or answer confirming that the precondition has been met when the requested preconditions have been met in the IP network, and a Continuity Testing (COT) message is received with the “Continuity Indicators” parameter set to “continuity check successful” before the expiration of the ISUP T8 timer.

SIP-008440.d If the COT message is received with the “Continuity Indicators” parameter set to “continuity check failed,” or if the ISUP timer T8 expires before receiving the COT message AND the originating gateway has not received a final response to the INVITE, then the originating gateway MUST send a CANCEL onto the IP network and a REL with cause value 47 (Resource Unavailable, Unspecified) to the SS7 network.

SIP-008440.e If the COT message is received with the “Continuity Indicators” parameter set to “continuity check failed,” or if the ISUP timer T8 expires before receiving the COT message AND the originating gateway has received a final response to the INVITE, then the originating gateway MUST send a BYE with cause value 47 (Resource Unavailable, Unspecified) onto the IP network and a REL with cause value 47 (Resource Unavailable, Unspecified) to the SS7 network.

12.6.2.2 Originating Gateway Maps ISUP IAM Parameters to AS-SIP INVITE Headers

Request-URI Field [RFC 3398, Section 8.2.1.1]

SIP-008450 The Request-URI field MUST be a SIP URI.

SIP-008460 The Request-URI MUST include the “user=phone” URI parameter.

SIP-008470 [Conditional] If the Forward Call Indicator (FCI) “number translated” bit (i.e., the “M” bit) is set to one indicating that an LNP dip has occurred:

SIP-008470.a If a “Generic Digits” parameter is present (a Generic Address Parameter (GAP) in ANSI ISUP):

SIP-008470.a.1 Generic Digits (or GAP) value in the form of a SIP URI MUST be placed in the Request-URI field.

SIP-008470.a.2 An “npdi=yes” field MUST be appended to the SIP URI.

SIP-008470.a.3 The contents of the Calling Party Number (CPN) MUST be copied into an “rn=” field, which is appended to the SIP URI.

SIP-008470.b If a “Generic Digits” parameter (or GAP) is NOT present and both the Location Routing Number (LRN) and the dialed number are in the “CPN” parameter, then the dialed number in the form of a SIP URI MUST be placed in the Request-URI field, the “npdi=yes” field MUST be appended, and the LRN copied into a “rn=” field and appended to the Request-URI.

SIP-008480 If the FCI “number translated” bit indicates that an LNP dip has NOT occurred:

SIP-008480.a The CPN in the form of a SIP URI MUST be placed in the Request-URI field.

SIP-008490 If either the “CIP” (ANSI) or “TNS” (ITU-T) parameter is present and has a value, then a “cic=” field with the value from the “CIP” or “TNS” parameter SHOULD be appended to the SIP URI. The “cic=” parameter MUST be prefixed with the country code of the “CPN” parameter, for example, CIC “5062” for a U.S. CPN is “+1-5062.”

To Header Field [RFC 3398, Section 8.2.1.1]

SIP-008500 If the “Original Called Number (OCN)” parameter is present in the IAM, then the telephone number in the “OCN” parameter, in the form of a SIP URI, SHOULD be placed in the To header field.

SIP-008510 If the “OCN” parameter is NOT present, then the value of the To header field is the same as the value of the Request-URI field.

From Header Field [ITU-T Recommendation Q.1912.5, Section 7.1.3]

SIP-008520 (ANSI ISUP) If the CPN field is not present in the IAM, then the From header field MUST be populated with a SIP URI that consists of a user portion with the value unavailable and the hostname of the originating gateway (e.g., sip:unavailable@DODgw.com).

SIP-008530 (ITU-T ISUP) If the CPN field is not present in the IAM and the IAM does not have a “Generic Number” parameter (ITU ISUP only), then the From header field MUST be populated with a SIP URI that consists of a user portion with the value unavailable and the hostname of the originating gateway (e.g., sip:unavailable@DODgw.com).

SIP-008540 (ITU-T ISUP) If the CPN field is not present in the IAM and the IAM has a “Generic Number” parameter (ITU ISUP only) where the “presentation indicator” field is NOT set to “presentation allowed,” then the From header field MUST be populated with a SIP URI that consists of a user portion with the value unavailable and the hostname of the originating gateway (e.g., sip:unavailable@DODgw.com).

SIP-008550 (ITU-T ISUP) If the CPN Field is not present in the IAM and the IAM has a “Generic Number” parameter (ITU ISUP only) where the “presentation indicator” field is set to “presentation allowed,” then the From header field **MUST** be populated with a SIP URI derived from the “Generic Number” parameter.

SIP-008560 When the “calling party number (CPN)” parameter is present and the “presentation indicator” field is set to “presentation allowed,” then:

- The From header field **MUST** be populated either with a SIP URI derived from the calling party number or
- The originating gateway **MUST** include a P-Asserted-Identity header derived from the calling party number in the form of a SIP URI. [RFC 3325] In the case of a DSN number, the PAssertedID-value **MUST** contain the SIP URI of the calling party where the userinfo part includes the full 10-digit DSN number.

SIP-008570 When the “calling party number” parameter is present and the “presentation indicator” field is set to “presentation restricted,” then:

- The From header field **SHOULD** be populated with a SIP URI with a display name and username of “Anonymous” (e.g., From: Anonymous <sip:anonymous@anonymous.invalid>),
- The originating gateway **MAY** include a Privacy header field with priv-value equal to “id,” (RFC 3323, RFC 3325, Q.1912.5) or
- The originating gateway **MUST** include a P-Asserted-Identity header derived from the calling party number in the form of a SIP URI (RFC 3325). In the case of a DSN number, the PAssertedID-value **MUST** contain the SIP URI of the calling party where the userinfo part includes the full 10-digit DSN number.

SIP-008580 When the “calling party number” parameter is present and the “presentation indicator” field is set to “address unavailable,” then the From header field **SHOULD** be populated with a SIP URI that consists of the hostname of the originating gateway without a user portion (RFC 3398).

SDP Information [ITU-T Recommendation Q.1912.5, Section 7.1.1]

SIP-008590 [Table 12.6-1](#), 26/Q.1912, describes the mapping between the relevant fields in the “Transmission Medium Requirement/User Service Information (TMR/USI)” parameters and the SDP media description lines when transcoding is not available at the originating gateway. This table is copied here for the reader’s convenience.

NOTE: The “TMR” is a mandatory parameter in the ITU-T ISUP IAM but is not present in the ANSI ISUP IAM. There is an optional USI parameter in ITU ISUP and a similar, but not identical mandatory, “USI” parameter in the ANSI ISUP IAM.

Table 12.6-1. 26/Q.1912

TMR PARAMETER	USI PARAMETER		HLC IE IN ATP	M= LINE			B= LINE	A= LINE
TMR codes	Information Transport Capability	User Information Layer 1 Protocol Indicator	High Layer Characteristics Identification	<media>	<transport>	<fmt-list>	<modifier>: <bandwidth-value>	rtpmap:<dynamic-PT> <encoding name>/<clock rate>/<encoding parameters>
“speech”	“Speech”	“G.711 μ-law”	Ignore	Audio	RTP/AVP	0 (and possibly 8) ¹	AS:64	rtpmap:0 PCMU/8000 (and possibly rtpmap:8 PCMA/8000) ¹
“speech”	“Speech”	“G.711 μ-law”	Ignore	Audio	RTP/AVP	Dynamic PT (and possibly a second Dynamic PT) ¹	AS:64	rtpmap:<dynamic-PT> PCMU/8000 (and possibly rtpmap:<dynamic-PT> PCMA/8000) ¹
“speech”	“Speech”	“G.711 a-law”	Ignore	Audio	RTP/AVP	8	AS:64	rtpmap:8 PCMA/8000
“speech”	“Speech”	“G.711 a-law”	Ignore	Audio	RTP/AVP	Dynamic PT	AS:64	rtpmap:<dynamic-PT> PCMA/8000
“3.1 KHz audio”	USI Absent		Ignore	Audio	RTP/AVP	0 and/or 8 ¹	AS:64	rtpmap:0 PCMU/8000 and/or rtpmap:8 PCMA/8000 ¹
“3.1 KHz audio”	“3.1 KHz audio”	“G.711 μ-law”	Note 3	Audio	RTP/AVP	0 (and possibly 8) ¹	AS:64	rtpmap:0 PCMU/8000 (and possibly rtpmap:8 PCMA/8000) ¹
“3.1 KHz audio”	“3.1 KHz audio”	“G.711 a-law”	Note 3	Audio	RTP/AVP	8	AS:64	rtpmap:8 PCMA/8000
“3.1 KHz audio”	“3.1 KHz audio”		“Facsimile Group 2/3”	Image	udptl	t38	AS:64	Based on T.38.
“3.1 KHz audio”	“3.1 KHz audio”		“Facsimile Group 2/3”	Image	tcptl	t38	AS:64	Based on T.38.

TMR PARAMETER	USI PARAMETER		HLC IE IN ATP	M= LINE			B= LINE	A= LINE
“64 kbit/s unrestricted”	“Unrestricted digital inf. W/tone/ann.”	N/A	Ignore	Audio	RTP/AVP	9	AS:64	rtpmap:9 G722/8000
“64 kbit/s unrestricted”	“Unrestricted digital information”	N/A	Ignore	Audio	RTP/AVP	Dynamic PT	AS:64	rtpmap:<dynamic-PT> CLEARMODE/8000 ²
“2 x 64 kbit/s unrestricted”	“Unrestricted digital information”	N/A	Ignore	FFS	FFS	FFS	FFS	FFS
“384 kbit/s unrestricted”	“Unrestricted digital information”	N/A	Ignore	FFS	FFS	FFS	FFS	FFS
“1536 kbit/s unrestricted”	“Unrestricted digital information”	N/A	Ignore	FFS	FFS	FFS	FFS	FFS
“1920 kbit/s unrestricted”	“Unrestricted digital information”	N/A	Ignore	FFS	FFS	FFS	FFS	FFS
“N x 64 kbit/s unrestricted” N from 3 to 29	“Unrestricted digital information”	N/A	Ignore	FFS	FFS	FFS	FFS	FFS

¹Both PCMA and PCMU required under the conditions stated in Q.1912.5, Section 7.1.1.

²Since CLEARMODE has not been standardized yet, its use is for further study.

³HLC normally is absent in this case. It is possible for HLC to be present with the value “Telephony,” although clause 6.3.1/Q.939 indicates that this would be accompanied normally by a value of “Speech” for the Information Transfer Capability element.

SIP-008600 If the originating gateway supports G.711 encoding and transcoding between a law and μ law:

SIP-008600.a If the call is from an a law TDM network, the originating gateway MUST send an SDP offer with both a PCMA and a PCMU in the media description and PCMA takes precedence over PCMU.

SIP-008600.b If the call is from a μ law TDM network the originating gateway MUST send an SDP offer with PCMU and optionally PCMA included in the media description and PCMU takes precedence over PCMA.

12.6.2.3 Originating Gateway Maps ISUP Messages to AS-SIP Messages

[ITU-T Recommendation Q.1912.5, Section 7.7.1]

SIP-008610 If the originating gateway receives a REL from the SS7 network before sending an INVITE to the IP network, then the INVITE is NOT sent.

SIP-008620 If the originating gateway receives a REL from the SS7 network after sending an INVITE to the IP network but before receiving a response, then the originating gateway holds the REL until an AS-SIP response is received and,

SIP-008620.a If the AS-SIP response does NOT establish a confirmed dialog (2xx) or early dialog (101-199), then the originating gateway sends a CANCEL. A Reason header field containing the (Q.850) cause value of the REL SHOULD be included in the CANCEL request.

NOTE: If the originating gateway receives a 200 (OK) INVITE after sending the CANCEL, the originating gateway MUST respond with an ACK, and then send a BYE request.

SIP-008620.b If the AS-SIP response does establish either an early dialog or confirmed dialog, then the originating gateway sends a BYE request mapping the “Cause Indicators” parameter to the SIP Reason header.

SIP-008630 If the originating gateway receives a REL from SS7 network after having received an AS-SIP response that established a confirmed dialog or early dialog, then the originating gateway MUST send a BYE request mapping the “Cause Indicators” parameter to the SIP Reason header.

NOTE: The Protocol field of the Reason header field will be assigned the value “Q.850,” the Protocol-cause field will be assigned the cause value from the REL, and the reason-text field will be based on the provisioning of the originating gateway.

[ITU-T Recommendation Q.1912.5, Section 7.7.4]

SIP-008640 When the originating gateway receives a Reset Circuit (RSC) message from the ISUP network:

- If the originating gateway receives an RSC from the SS7 network before sending an INVITE to the IP network, then the INVITE is NOT sent.

SIP-008650 If the originating gateway receives an RSC from the SS7 network after sending an INVITE to the IP network but before receiving a response:

SIP-008650.a If the AS-SIP response does NOT establish a confirmed dialog (2xx) or early dialog (101-199), then the originating gateway sends a CANCEL. A Reason header field containing the (Q.850) cause value of the REL that is being sent to the ISUP network SHOULD be included in the CANCEL request.

SIP-008650.b If the AS-SIP response does establish either an early dialog or confirmed dialog, then the originating gateway sends a BYE request mapping the “Cause Indicators” parameter to the SIP Reason header.

SIP-008660 If the originating gateway receives an RSC from the SS7 network after having received an AS-SIP response that established a confirmed dialog or early dialog, then the originating gateway MUST send a BYE request mapping the “Cause Indicators” parameter to the SIP Reason header.

[ITU-T Recommendation Q.1912.5, Section 7.7.4]

SIP-008670 When the originating gateway receives a circuit Group Reset (GRS) message from the ISUP network:

- If the originating gateway receives a GRS from the SS7 network before sending an INVITE to the IP network, then the INVITE is NOT sent.

SIP-008680 If the originating gateway receives GRS from the CCS7 network after sending an INVITE to the IP network but prior to receiving a response:

SIP-008680.a If the AS-SIP response does NOT establish a confirmed dialog (2xx) or early dialog (101–199), then the originating gateway sends a CANCEL. A Reason header field containing the (Q.850) cause value of the REL that is being sent to the ISUP network SHOULD be included in the CANCEL Request.

SIP-008680.b If the AS-SIP response does establish either an early dialog or confirmed dialog, then the originating gateway sends a BYE request mapping the “Cause Indicators” parameter to the SIP Reason header.

SIP-008690 If the originating gateway receives a GRS from the SS7 network after having received a response that established a confirmed dialog or early dialog, then the originating

gateway MUST send a BYE request mapping the “Cause Indicators” parameter to the SIP Reason header.

NOTE: One SIP message MUST be sent for each call affected by the GRS.

[ITU-T Recommendation Q.1912.5, Section 7.7.4]

SIP-008700 When the originating gateway receives a Circuit Group Blocking (CGB) message with the Circuit Group Supervision Message Type indicator set to “hardware failure oriented” from the ISUP network:

- If the originating gateway receives a CGB from the SS7 network before sending an INVITE to the IP network, then the INVITE is NOT sent.

SIP-008710 If the originating gateway receives a CGB with the Circuit Group Supervision Message Type indicator set to “hardware failure oriented” from the ISUP network after sending an INVITE to the IP network but before receiving a response:

SIP-008710.a If the AS-SIP response does NOT establish a confirmed dialog (2xx) or early dialog (101–199), then the originating gateway sends a CANCEL. A Reason header field containing the (Q.850) cause value of the REL that is being sent to the ISUP network SHOULD be included in the CANCEL request.

SIP-008710.b If the AS-SIP response does establish either an early dialog or confirmed dialog, then the originating gateway sends a BYE request mapping the “Cause Indicators” parameter to the SIP Reason header.

SIP-008720 If the originating gateway receives a CGB with the Circuit Group Supervision Message Type indicator set to “hardware failure oriented” from the ISUP network after having received an AS-SIP response that established a confirmed dialog or early dialog, then the originating gateway MUST send a BYE request mapping the “Cause Indicators” parameter to the SIP Reason header.

NOTE: One SIP message MUST be sent for each call affected by the CGB.

12.6.2.4 Autonomous Release by Originating Gateway

[ITU-T Recommendation Q1912.5, Section 7.7.3]

SIP-008730 [Table 12.6-2](#), 37/Q.1912.5, details the events that trigger an autonomous release by the originating gateway resulting in the transmission of a CANCEL or BYE request to the IP network and a REL to the SS7 network.

Table 12.6-2. 37/Q.1912.5

REL ← CAUSE INDICATORS PARAMETER	TRIGGER EVENT	→ SIP
As determined by ISUP procedure	COT received with the “Continuity Indicators” parameter set to “continuity check failed” (ISUP only) or the ISUP timer T8 expires	Send CANCEL or BYE request according to the rule described in section titled OG Mapping of ISUP REL Message to SIP Message.
REL with cause value 47 (Resource Unavailable, Unspecified)	Internal resource reservation unsuccessful	As determined by SIP procedure.
As determined by ISUP procedure	ISUP procedures result in generation of autonomous REL on ISUP side.	CANCEL or BYE request according to the rule described in section titled OG Mapping of ISUP REL Message to SIP Message.
Depending on the SIP release reason	SIP procedures result in a decision to release the call.	As determined by SIP procedure.

SIP-008740 A Reason header field containing the (Q.850) cause value of the REL SHOULD be included in the BYE request or CANCEL request.

12.6.2.5 Originating Gateway Maps AS-SIP Messages to ISUP Messages

180 Ringing [ITU-T Recommendation Q.1912.5, Section 7.3.1]

SIP-008750 When an originating gateway receives a 180 (Ringing) response:

SIP-008750.a The originating gateway MUST stop the ISUP T11 timer.

SIP-008750.b The originating gateway will use its standard ISUP procedures to determine whether to send an ACM or CPG over the ISUP network.

SIP-008750.c In the case of the ACM, the called party’s status indicator of the BCI is set to “subscriber free” (bit DC 01).

SIP-008750.d In the case of the ACM for a call that originates in a SIP mobile network, the Interworking indicator of the BCI is set to “interworking encountered” (bit I 1).

SIP-008750.e In the case of the ACM for a call that originates in a SIP mobile network, the ISUP indicator of the BCI is set to “ISUP not used all the way” (bit K 0).

SIP-008750.f In the case of the ACM for a call that originates in a SIP mobile network, the ISDN access indicator of the BCI is set to “terminating access non-ISDN” (bit M 0).

SIP-008750.g In the case of the CPG, the Event indicator of the “Event Information” parameter is set to “alerting” (GFEDCBA 000001).

SIP-008750.h The originating gateway transmits a ringing tone on the TDM bearer circuit to the caller.

183 Session Progress [ITU-T Recommendation Q.1912.5, Section 7.3.2]

SIP-008760 If a 183 (Session Progress) response is received, then the originating gateway MUST NOT send an ISUP message onward over the ISUP network.

200 (OK) INVITE [ITU-T Recommendation Q.1912.5, Section 7.5]

SIP-008770 When an originating gateway receives a 200 (OK) INVITE:

SIP-008770.a The originating gateway MUST stop the ISUP timer T11.

SIP-008770.b (ITU ISUP) The originating gateway will use its standard ISUP procedures to determine whether to send an ANM or CON over the ISUP network.

NOTE: The CON is an ITU ISUP message (not used in ANSI ISUP) indicating that sufficient information has been received and that the called subscriber has answered. It serves as both an ACM and an ANM.

SIP-008770.c (ANSI ISUP) The originating gateway will send an ANM over the ISUP network.

SIP-008770.d The originating gateway will terminate the ringing tone to the calling party.

SIP-008770.e (ITU ISUP) If the originating gateway creates a CON message, then the called party's status indicator of the BCI is set to "no indication" (bit DC 00), and if the call originates in a SIP mobile network, then the Interworking indicator of the BCI is set to "interworking encountered" (bit I 1), the ISUP indicator of the BCI is set to "ISUP not used all the way" (bit K 0), and the ISDN access indicator of the BCI is set to "terminating access non-ISDN" (bit M 0).

BYE [ITU-T Recommendation Q.1912.5, Section 7.7.2]

SIP-008780 When the originating gateway receives a BYE:

SIP-008780.a The originating gateway creates a REL to send over the ISUP network.

SIP-008780.b If the BYE includes a Reason header field with a Q.850 cause value, then the Q.850 cause value MAY be mapped to the cause value of the "Cause Indication" parameter of the REL and the location field of the "Cause Indication" parameter is assigned "network beyond interworking point."

SIP-008780.c If the cause value is not available from the Reason header field, then cause value 16 ("Normal Clearing") is placed in the "Cause Indicators" parameter of the REL.

4XX, 5XX, 6XX [ITU-T Recommendation Q.1912.5, Section 7.7.6]

SIP-008790 When the originating gateway receives a 4XX, 5XX, 6XX response to the INVITE, then:

SIP-008790.a If a Reason header field with a Q.850 cause value is present, then the Q.850 cause value SHOULD be mapped to the cause value of the “Cause Indication” parameter of the REL and the location field of the “Cause Indication” parameter is assigned “network beyond interworking point.”

Otherwise the 4XX, 5XX, 6XX response code is mapped to the REL ISUP cause value IAW [Table 12.6-3](#), 40/Q.1912.5, which is copied here for the reader’s convenience.

Table 12.6-3. 40/Q.1912.5

←REL (CAUSE VALUE)	←4XX/5XX/6XX SIP MESSAGE	REMARKS
127 Interworking	400 Bad Request	
127 Interworking	401 Unauthorized	Note 1
127 Interworking	402 Payment Required	
127 Interworking	403 Forbidden	
1 Unallocated number	404 Not Found	
127 Interworking	405 Method Not Allowed	
127 Interworking	406 Not Acceptable	
127 Interworking	407 Proxy authentication Required	Note 1
127 Interworking	408 Request Timeout	
22 Number changed (without diagnostic)	410 Gone	
127 Interworking	413 Request Entity Too Long	Note 1
127 Interworking	414 Request-uri Too Long	Note 1
127 Interworking	415 Unsupported Media Type	Note 1
127 Interworking	416 Unsupported URI Scheme	Note 1
127 Interworking	420 Bad Extension	Note 1
127 Interworking	421 Extension Required	Note 1
127 Interworking	423 Interval Too Brief	
20 Subscriber absent	480 Temporarily Unavailable	
127 Interworking	481 Call/Transaction Does Not Exist	
127 Interworking	482 Loop Detected	
127 Interworking	483 Too Many Hops	
28 Invalid Number format	484 Address Incomplete	Note 1
127 Interworking	485 Ambiguous	
17 User busy	486 Busy Here	

←REL (CAUSE VALUE)	←4XX/5XX/6XX SIP MESSAGE	REMARKS
127 Interworking or no mapping (Note 3)	487 Request Terminated	Note 2
127 Interworking	488 Not Acceptable Here	
No mapping	491 Request Pending	Note 2
127 Interworking	493 Undecipherable	
127 Interworking	500 Server Internal Error	
127 Interworking	501 Not Implemented	
127 Interworking	502 Bad Gateway	
127 Interworking	503 Service Unavailable	Note 1
127 Interworking	504 Server Timeout	
127 Interworking	505 Version Not Supported	Note 1
127 Interworking	513 Message Too Large	Note 1
127 Interworking	580 Precondition Failure	Note 1
17 User busy	600 Busy Everywhere	
21 Call rejected	603 Decline	
1 Unallocated number	604 Does Not Exist Anywhere	
127 Interworking	606 Not Acceptable	
Note 1 – This response may be handled entirely on the SIP side; if so, it is not interworked. Note 2 – This response does not terminate a SIP dialog, but only a specific transaction within it. Note 3 – No mapping if the O-IWU previously issued a CANCEL request for the INVITE.		

12.7 TRANSLATION REQUIREMENTS FOR AN INTERWORKING AS-SIP SIGNALING APPLIANCE OPERATING AS A TERMINATING GATEWAY

12.7.1 General Requirements

SIP-008800 The terminating gateway **MUST** include a to-tag in the first backward non-100 provisional response to establish an early dialog (ITU-T Recommendation Q.1912.5, Section 6).

12.7.2 TDM Bridging and IP-to-TDM Call Flow Requirements (Terminating Gateway)

12.7.2.1 Terminating Gateway Receives AS-SIP INVITE

SIP-008810 When the terminating gateway receives an INVITE from the IP network, the terminating gateway **MUST** ensure that a complete telephone number has been received in the INVITE before an IAM is transmitted to the ISUP network.

[ITU-T Recommendation Q.1912.5, Sections 6.1.1 and 6.1.2]

SIP-008820 When the terminating gateway receives an INVITE with a complete telephone number for purposes of routing to the ISUP network, and the INVITE does not include an SDP offer:

SIP-008820.a In compliance with Requirement SIP-000460, the INVITE MUST indicate support for reliable provisional responses (e.g., INVITE has Require header field or Support header field with option tag “100rel”) in which case:

SIP-008820.a.1 If the call is to be routed over an a-law TDM network, the terminating gateway MUST send a 183 (Session Progress) response having an SDP offer with PCMA and PCMU in the media description (assuming the terminating gateway supports G.711 encoding) with PCMA having precedence over PCMU.

SIP-008820.a.2 If the call is to be routed over a μ -law TDM network, the terminating gateway MUST send a 183 (Session Progress) response having an SDP offer with PCMU in the media description and MAY optionally include PCMA and PCMU will take precedence over PCMA, if present (assuming the terminating gateway supports G.711 encoding and transcoding between A-Law and μ -Law).

SIP-008820.a.3 If SIP preconditions are not being used for this call request, the terminating gateway MUST send the IAM when it receives the SDP answer with the media description.

SIP-008820.a.4 If SIP precondition signaling is being used AND the subsequent ISUP network supports continuity checking, the terminating gateway will immediately send out the IAM and set the Continuity Check indicator in the “Nature of Connections Indicator” parameter to “continuity check performed on previous circuit” or “continuity check required on this circuit” (if COT check is to be performed on outgoing circuit).

SIP-008820.a.5 If SIP precondition signaling is being used AND the subsequent ISUP network does not support continuity checking, the terminating gateway will defer sending the IAM until all preconditions are met.

SIP-008820.b If, in violation of Requirement SIP-000460, the INVITE does not include a Supported header with the option tag “100rel,” the terminating gateway MUST immediately send out the IAM over the ISUP network.⁹⁶

SIP-008830 When the terminating gateway receives an INVITE with a complete telephone number for purposes of routing to the ISUP network, and the INVITE includes an SDP offer:

⁹⁶ The first non-failure provisional response sent by the terminating gateway MUST include an sdp offer.

SIP-008830.a If the terminating gateway operates as an International gateway and uses G.711 encoding:

SIP-008830.a.1 If the call is going onto an a-law TDM network, the terminating gateway MUST delete the μ -law media description if present from the SDP answer in the first non-failure provisional response it sends back in response to the receipt of the INVITE.

SIP-008830.a.2 If the call is going onto an μ -law TDM network and both a-law and μ -law were present in the offer, then the terminating gateway MUST delete the a-law from the media description from the SDP answer in the first non-failure provisional response it sends back in response to the receipt of the INVITE.

SIP-008830.b If SIP preconditions are not being used, then the terminating gateway MUST immediately send the IAM onto the ISUP network.

SIP-008830.c If SIP precondition signaling is being used AND the subsequent ISUP network supports continuity checking, the terminating gateway will immediately send out the IAM and set the Continuity Check indicator in the “Nature of Connections Indicator” parameter to “continuity check performed on previous circuit” or “continuity check required on this circuit” (if a COT check is to be performed on outgoing circuit).

SIP-008830.d If SIP precondition signaling is being used AND the subsequent ISUP network does not support continuity checking, the terminating gateway will defer sending the IAM until all preconditions are met.

SIP-008830.e The first non-failure provisional response sent by the terminating gateway MUST include an sdp answer.

12.7.2.2 Terminating Gateway Maps AS-SIP INVITE Headers to ISUP IAM Parameters

Called Party Number [RFC 3398, Section 7.2.1.1]

SIP-008840 When the terminating gateway receives an AS-SIP INVITE:

SIP-008840.a If there is no “npdi=yes” field within the Request-URI, then the telephone number in the userinfo part of the SIP URI MUST be converted to ISUP format and placed in the “CPN” parameter.

SIP-008840.b [Conditional] If there is a “npdi=yes” field within the Request URI field, but no “rn=” field, then the telephone number of the userinfo part of the SIP URI of the Request-URI field MUST be converted to ISUP format and placed in the “CPN” parameter.

SIP-008840.c [Conditional] If there is a “npdi=yes” field within the Request URI and an “rn=” field, then the telephone number in the “rn=” field MUST be converted to ISUP format and placed in the “CPN” parameter. The telephone number in the Request-URI field MUST be converted to ISUP format and placed in the “Generic Digits” (GAP) parameter.

SIP-008850 If the primary telephone number in the Request-URI and that of the To header are at variance, then the To header SHOULD be used to populate an OCN parameter. Otherwise the To header field SHOULD be ignored (RFC 3398).

SIP-008860 If the “cic=” parameter is present in the Request-URI, then if local policy supports transmission of the Carrier Identification Code in the IAM, then the terminating gateway policy determines whether the CIC is carried in the “CIP” or “TNS” parameter.

SIP-008870 The information contained in the INVITE Request-URI field, specifically the telephone number in the userinfo part of the SIP URI, MUST be converted to ISUP format and placed in the “CPN” parameter.

SIP-008880 If the number in the Request-URI field being converted to ISUP format is a global E.164 number, the NoA indicator is set to “International number” and the Numbering Plan indicator is set to “ISDN numbering plan (Recommendation E.164).”

SIP-008890 If the number in the Request-URI field being converted to ISUP format belongs to the DSN worldwide numbering plan, then the NoA indicator is set to “Subscriber number” and the Numbering Plan indicator is set to “Private numbering plan.”

SIP-008900 If the number in the Request-URI field being converted to ISUP format is a National number, then the NoA indicator is set to “National significant number” and the Numbering Plan indicator is set to “ISDN numbering plan (Recommendation E.164).”

NOTE: This case SHOULD NOT occur, because AS-SIP signaling appliances that receive a call request from a served IP EI intended for the PSTN MUST convert National significant numbers to International E.164 numbers.

Calling Party’s Category [ITU-T Recommendation Q.1912.5, Section 6.1.3.2]

SIP-008910 The calling party’s category is set to “calling party’s category unknown” (bit 0000 0000).

Nature of Connection Indicators [ITU-T Recommendation Q.1912.5, Section 6.1.3.3]

SIP-008920 The Satellite indicator SHOULD be set to “One satellite circuit in the connection” (bit BA 01).

SIP-008930 The Continuity Check indicator SHOULD be set to “Continuity check not required” (bit DC 00) if there is no pending precondition request.

SIP-008940 The Continuity Check indicator SHOULD be set to “Continuity check performed on a previous circuit” (bit DC 10) if there is a pending precondition request.

SIP-008950 The Echo Control Device indicator SHOULD be set to “outgoing echo control device included” (bit E 1) if the INVITE is from a mobile network.

Forward Call Indicators [Q.1912.5, Section 6.1.3.4]

SIP-008960 The Interworking indicator SHOULD be set to “Interworking encountered” (bit D 1).

SIP-008970 The ISUP indicator SHOULD be set to “ISUP not used all the way” (bit F 0).

SIP-008980 The ISUP Preference indicator SHOULD be set to “ISUP not required all the way” (bit HG 01) unless the INVITE is from a mobile network; in which case, the ISUP Preference indicator will be set IAW local policy.

SIP-008990 The ISDN Access indicator SHOULD be set to “Originating access non-ISDN” (bit I 0).

TMR/USI User Service Information/Transmission Medium Requirement (TMR/USI) [ITU-T Recommendation Q.1912.5, Section 6.1.3.5]

SIP-009000 (ITU ISUP only) If the call originates from a mobile IP network, the “TMR” parameter MUST be set to 3.1 kHz audio, the optional “USI” parameter is NOT sent, and transcoding is applied when required.

SIP-009010 (ANSI ISUP only) If the call originates from a mobile IP network, the information transfer capability of the “USI” parameter MUST be set to 3.1 kHz audio.

SIP-009020 (ITU ISUP) If the call does not originate from a mobile network and the SDP is received by the terminating gateway before the IAM is sent and if transcoding between a-law and μ -law is not supported by the terminating gateway, the values for the mandatory “TMR” parameter and the optional “USI” parameter will be derived from the SDP as detailed in [Table 12.1-8](#), 6/Q1912.5, which is copied here for the reader’s convenience.

SIP-009030 (ITU ISUP) If the call does not originate from a mobile network and the SDP is received by the terminating gateway after the IAM is sent, the bearer service values defined by the mandatory “TMR” parameter and the optional “USI” parameter will be set IAW local policy.

SIP-009040 (ITU ISUP) If the call does not originate from a mobile network and if transcoding between a-law and μ -law is supported by the terminating gateway, the bearer service values defined by the mandatory “TMR” parameter and the optional “USI” parameter will be set IAW local policy.

SIP-009050 (ANSI ISUP) If the call does not originate from a mobile network and the SDP is received by the terminating gateway before the IAM is sent, and if transcoding between a-law

and μ -law is not supported by the terminating gateway, the values for the mandatory “USI” parameter will be derived from the SDP as detailed in [Table 12.7-1](#), 6/Q.1912.5, which is copied here for the reader’s convenience.

Table 12.7-1. 6/Q.1912.5

	M= LINE		B= LINE	A= LINE	“TMR” PARAMETER	“USI” PARAMETER3		“HLC” PARAMETER
<media>	<transport>	<fmt-list>	<modifier>: <bandwidth-value>	rtpmap:<dynamic-PT> <encoding name>/<clock rate>/<encoding parameters>	TMR codes	Information Transport Capability	User Information Layer 1 Protocol Indicator	High Layer Characteristics Identification
			NOTE – <bandwidth value> for <modifier> of AS is evaluated to be B kbit/s.					
audio	RTP/AVP	0	N/A or up to 64 kbit/s	N/A	“3.1KHz audio”	“3.1KHz audio”	“G.7111 mu-Law”	Note 3
audio	RTP/AVP	Dynamic PT	N/A or up to 64 kbit/s	rtpmap:<dynamic-PT> PCMU/8000	“3.1KHz audio”	“3.1KHz audio”	“G.7111 mu-Law”	Note 3
audio	RTP/AVP	8	N/A or up to 64 kbit/s	N/A	“3.1KHz audio”	“3.1KHz audio”	“G.7111 A-Law”	Note 3
audio	RTP/AVP	Dynamic PT	N/A or up to 64 kbit/s	rtpmap:<dynamic-PT> PCMA/8000	“3.1KHz audio”	“3.1KHz audio”	“G.7111 A-Law”	Note 3
audio	RTP/AVP	9	AS:64 kbit/s	rtpmap:9 G722/8000	“64 kbit/s unrestricted”	“Unrestricted digital inf. w/tones/ann”		
audio	RTP/AVP	Dynamic PT	AS:64 kbit/s	rtpmap:<dynamic-PT> CLEARMODE/80002	“64 kbit/s unrestricted”	“Unrestricted digital information”		
image	udptl	t38	N/A or up to 64 kbit/s	Based on T.38	“3.1 KHz audio”	“3.1KHz audio”		“Facsimile Group 2/3”
image	tcptl	t38	N/A or up to 64 kbit/s	Based on T.38	“3.1 KHz audio”	“3.1KHz audio”		“Facsimile Group 2/3”

NOTE 1: In this table, the codec G.711 is used only as an example. Another codec is possible.

NOTE 2: CLEARMODE has not been standardized yet and its usage is FFS.

NOTE 3: HLC normally is absent in this case. It is possible for HLC to be present with the value "Telephony," although clause 6.3.1/Q.939 indicates that this would be accompanied normally by a value of "Speech" for the Information Transfer Capability element.

SIP-009060 (ANSI ISUP) If the call does not originate from a mobile network and the SDP is received by the terminating gateway after the IAM is sent, the bearer service values defined by the mandatory “TMR” parameter and the optional “USI” parameter will be set IAW local policy.

SIP-009070 (ANSI ISUP) If the call does not originate from a mobile network and if transcoding between a-law and μ -law is supported by the terminating gateway, the bearer service values defined by the mandatory “TMR” parameter and the optional “USI” parameter will be set IAW local policy.

SIP-009080 (ITU ISUP) If the terminating gateway is an International gateway and the audio coding is G.711, and the incoming call is treated as an ISDN originated call, the User Information Layer 1 Protocol indicator of the optional “USI” parameter MUST be set IAW the encoding law (i.e., a-law or μ -law) of the succeeding SS7 network.

SIP-009090 (ANSI ISUP) If the terminating gateway is an International gateway and the audio coding is G.711, and the incoming call is treated as an ISDN originated call, the User Information Layer 1 Protocol indicator of the mandatory “USI” parameter MUST be set IAW the encoding law (i.e., a-law or μ -law) of the succeeding SS7 network.

Calling Party Number [ITU-T Recommendation Q.1912.5, Section 6.1.3.6]

SIP-009100 When the terminating gateway receives the AS-SIP INVITE:

SIP-009100.a If the From header field does not have a SIP URI with a telephone number for the user part of the URI, AND if there is no P-Asserted-Identity header⁹⁷ or a P-Asserted-Identity header that does not have a SIP URI with a telephone number for the user part of the URI, the terminating gateway SHOULD omit the “CPN” parameter from the IAM.

SIP-009100.b If the From header field does not have a SIP URI with a telephone number for the user part of the URI AND if there is a P-Asserted-Identity header with a SIP URI with a telephone number for the user part of the URI, AND there is either no Privacy header field or a Privacy header field where the priv-value is “none,” then the terminating gateway MUST place the telephone number from the P-Asserted-Identity header field into the calling party number field, and:

SIP-009100.b.1 In the case of a number from the DSN worldwide numbering plan, set the NoA indicator to “Subscriber number” and the Numbering Plan indicator to “Private numbering plan”; set the Screening indicator to “Network provided”; and set the Presentation indicator to “Presentation allowed.”

SIP-009100.b.2 In the case of a PSTN number, set the NoA indicator to “unique international number” or to “national (significant) number,” as appropriate; set the

⁹⁷ The presence of a P-Asserted-Identity header is mandated by UCR Requirement SIP-000570.

Screening indicator to “Network provided”; and set the Presentation indicator to “Presentation allowed.”

SIP-009100.c If the From header field does not have a SIP URI with a telephone number for the user part of the URI AND if there is a P-Asserted-Identity header with a SIP URI with a telephone number for the user part of the URI, AND there is a Privacy header where the priv-value is “header,” or “user,” or “id”:

SIP-009100.c.1 If the terminating gateway will be forwarding the IAM to an untrusted network, then the terminating gateway MUST NOT add a “CPN” parameter to the IAM, or

SIP-009100.c.2 If the terminating gateway will be forwarding the IAM to a trusted network, the terminating gateway MUST place the telephone number from the P-Asserted-Identity header into the calling party number field, and:

SIP-009100.c.2.a In the case of a number from the DSN worldwide numbering plan, set the NoA indicator to “Subscriber number” and Numbering Plan indicator to “Private numbering plan”; set the Screening indicator to “Network provided”; and set the Presentation indicator to “Presentation allowed.”

SIP-009100.c.2.b In the case of a PSTN number, set the NoA indicator to “unique international number” or to “national (significant) number,” as appropriate; set the Screening indicator to “Network provided”; and set the Presentation indicator to “Presentation allowed.”

SIP-009100.d If the From header field has a SIP URI with a telephone number for the user part of the URI AND if there is no P-Asserted-Identity header⁹⁸ or a P-Asserted-Identity header that does not have a SIP URI with a telephone number for the user part of the URI, AND there is either no Privacy header field or a Privacy header field where the priv-value is “none”:

SIP-009100.d.1 The terminating gateway MUST place the telephone number in the From header field into the calling party number field, and:

SIP-009100.d.1.a In the case of a number from the DSN worldwide numbering plan, set the NoA indicator to “Subscriber number” and the Numbering plan indicator to “Private numbering plan”; set the Screening indicator to “User provided”; and set the Presentation indicator to “Presentation allowed.”

SIP-009100.d.1.b In the case of a PSTN number, set the NoA indicator to “unique international number” or to “national (significant) number,” as

⁹⁸ The presence of a P-Asserted-Identity header is mandated by Requirement SIP-000570.

appropriate; set the Screening indicator to “User provided”; and set the Presentation indicator to “Presentation allowed.”

AND

SIP-009100.d.2 (ITU ISUP only) In the case of a PSTN number, the terminating gateway SHOULD place the telephone number in the From header field into the Generic Number field, set the Number Qualifier indicator to “additional calling party number”; set the NoA indicator to “unique international number” or to “national (significant) number,” as appropriate; set the Number Incomplete indicator to “complete”; set the Numbering Plan indicator to “ISDN (telephony) numbering plan (Recommendation E.164)”; set the Screening indicator to “User provided, not verified”; and set the Presentation indicator to “Presentation allowed.”

SIP-009100.e If the From header field has a SIP URI with a telephone number for the user part of the URI AND if there is no P-Asserted-Identity header field or a P Asserted-Identity header field⁹⁹ that does not have a SIP URI with a telephone number for the user part of the URI AND there is a Privacy header field where the priv-value is “header” or “user” or “id,” then:

SIP-009100.e.1 The terminating gateway MUST place the telephone number in the From header field into the calling party number field, and:

SIP-009100.e.1.a In the case of a number from the DSN worldwide numbering plan, set the NoA indicator to “Subscriber number” and the Numbering Plan indicator to “Private numbering plan”; set the Screening indicator to “User provided”; and set the Presentation indicator to “Presentation restricted.”

SIP-009100.e.1.b In the case of a PSTN number, set the NoA indicator to “unique international number” or to “national (significant) number,” as appropriate; set the Screening indicator to “User provided”; and set the Presentation indicator to “Presentation restricted.”

AND

SIP-009100.e.1.c (ITU ISUP only) In the case of a PSTN number, the terminating gateway SHOULD place the telephone number in the From header field into the Generic Number field, set the Number Qualifier indicator to “additional calling party number”; set the NoA indicator to “unique international number” or to “national (significant) number,” as appropriate; set the Number Incomplete indicator to “complete”; set the Numbering Plan indicator to “ISDN (telephony) numbering plan

⁹⁹ The presence of a P-Asserted-Identity header is mandated by Requirement SIP-000570

(Recommendation E.164)”; set the Screening indicator to “User provided, not verified”; and set the Presentation indicator to “Presentation restricted.”

SIP-009100.f If the From header field has a SIP URI with a telephone number for the user part of the URI AND if there is a P-Asserted-Identity header field with a SIP URI with a telephone number for the user part of the URI, AND there is either no Privacy header field or a Privacy header field where the priv-value is “none”:

SIP-009100.f.1 The terminating gateway MUST place the telephone number from the P-Asserted-Identity header field into the calling party number field, and:

SIP-009100.f.1.a In the case of a number from the DSN worldwide numbering plan, set the NoA indicator to “Subscriber number” and the Numbering Plan indicator to “Private numbering plan”; set the Screening indicator to “Network provided”; and set the Presentation indicator to “Presentation allowed.”

SIP-009100.f.1.b In the case of a PSTN number, set the NoA indicator to “unique international number” or to “national (significant) number,” as appropriate; set the Screening indicator to “Network provided”; and set the Presentation indicator to “Presentation allowed.”

AND

SIP-009100.f.1.c (ITU ISUP only) In the case of a PSTN number, the terminating gateway SHOULD place the telephone number in the From header field into the Generic Number field, set the Number Qualifier indicator to “additional calling party number”; set the NoA indicator to “unique international number” or to “national (significant) number,” as appropriate; set the Number Incomplete indicator to “complete”; set the Numbering Plan indicator to “ISDN (telephony) numbering plan (Recommendation E.164)”; set the Screening indicator to “User provided, not verified”; and set the Presentation indicator to “Presentation allowed.”

SIP-009100.g If the From header field has a SIP URI with a telephone number for the user part of the URI AND if there is a P-Asserted-Identity header field with a SIP URI with a telephone number for the user part of the URI, AND there is a Privacy header field where the priv-value is “header” or “user” or “id”:

SIP-009100.g.1 If the terminating gateway will be forwarding the IAM to an untrusted network, the terminating gateway MUST omit the “CPN” parameter from the IAM, and in the case of a PSTN number (ITU ISUP only), MAY derive the telephone number for the Generic Number from the From header field and set the Number Qualifier indicator to “additional calling party number”; set the NoA

indicator to “unique international number” or to “national (significant) number,” as appropriate; set the Number Incomplete indicator to “complete”; set the Numbering Plan indicator to “ISDN (telephony) numbering plan (Recommendation E.164)”; set the Screening indicator to “User provided, not verified”; and set the Presentation indicator to “Presentation restricted.”

SIP-009100.g.2 If the terminating gateway will be forwarding the IAM to a trusted network, the terminating gateway **MUST** place the telephone number from the P-Asserted-Identity header field into the calling party number field, and:

SIP-009100.g.2.a In the case of a number from the DSN worldwide numbering plan, set the NoA indicator to “Subscriber number” and the Numbering Plan indicator to “Private numbering plan”; set the Screening indicator to “Network provided”; and set the Presentation indicator to “Presentation restricted.”

SIP-009100.g.2.b In the case of a PSTN number, set the NoA indicator to “unique international number” or to “national (significant) number,” as appropriate; set the Screening indicator to “Network provided”; and set the Presentation indicator to “Presentation restricted.”

AND

SIP-009100.g.2.c (ITU ISUP only) In the case of a PSTN number, it **MAY** derive the telephone number for the Generic Number from the From header field and set the Number Qualifier indicator to “additional calling party number,” set the NoA indicator to “unique international number” or to “national (significant) number,” as appropriate; set the Number Incomplete indicator to “complete”; set the Numbering Plan indicator to “ISDN (telephony) numbering plan (Recommendation E.164)”; set the Screening indicator to “User provided, not verified”; and set the Presentation indicator to “Presentation restricted.”

12.7.2.3 Terminating Gateway Maps ISUP Messages to AS-SIP Messages

[ITU-T Recommendation Q.1912.5, Section 6.4] (ITU ISUP only)

SIP-009110 When the terminating gateway receives a CON, the terminating gateway **MUST** send a 200 (OK) INVITE response.

[ITU-T Recommendation Q.1912.5, Section 6.5]

SIP-009120 When the terminating gateway receives an ACM and the called party’s status indicator of the ACM “BCI” parameter is set to “subscriber free,” (bit 01), the terminating gateway **MUST** send a 180 (Ringing) response.

SIP-009130 When the terminating gateway receives an ACM with cause parameters it is NOT interworked.

[ITU-T Recommendation Q.1912.5, Section 6.6]

SIP-009140 When the terminating gateway receives a CPG and the bits of the Event indicator of the “CPG Event Information” parameter indicate “alerting,” the terminating gateway MUST send a 180 (Ringing) response.

SIP-009150 When the terminating gateway receives a CPG and the bits of the Event indicator of the “CPG Event Information” parameter indicate either “progress” or “in-band information or an appropriate pattern is now available,” the terminating gateway generally does not interwork the CPG. An exception to this rule is that the CPG is interworked when the Generic Notification indicator is set to “remote hold” or “remote retrieval” in support of the call hold supplementary service as depicted in [Figure 16.3-1](#), TDM Bridging Call Hold, and [Figure 16.3-5](#), IP-to-TDM Call Hold; IP Party Places Call On Hold.

SIP-009160 When the terminating gateway receives an ANM, the terminating gateway MUST send a 200 (OK) response. [ITU-T Recommendation Q.1912.5, Section 6.7]

SIP-009170 When the terminating gateway receives a REL subsequent to receiving an ANM or CON (ITU ISUP only): [ITU-T Recommendation Q.1912.5, Section 6.11.2]

SIP-009170.a The terminating gateway MUST send an RLC onto the SS7 network.

SIP-009170.b The terminating gateway MUST send a BYE and SHOULD include a Reason header field where the protocol field is assigned the value “Q.850,” the protocol-cause field is assigned the cause value from the REL, and the Reason-Text field is based on the provisioning of the terminating gateway.

SIP-009180 When the terminating gateway receives a REL before receiving an ANM or CON (ITU ISUP only): [ITU-T Recommendation Q.1912.5, Section 6.11.2]

SIP-009180.a The terminating gateway MUST send an RLC onto the SS7 network.

SIP-009180.b The terminating gateway MUST send the appropriate response as described in [Table 12.7-2](#), 21/Q.1912.5, and copied here for the reader’s convenience. [ITU-T Recommendation Q1912.5, Section 6.11.2]

Table 12.7-2. 21/Q.1912.5

←SIP MESSAGE	← REL CAUSE INDICATORS PARAMETER
404 Not Found	Cause Value No. 1 (“unallocated (unassigned) number”)
500 Server Internal Error	Cause Value No. 2 (“no route to network”)
500 Server Internal Error	Cause Value No. 3 (“no route to destination”)

←SIP MESSAGE	← REL CAUSE INDICATORS PARAMETER
500 Server Internal Error	Cause Value No. 4 (“Send special information tone”)
404 Not Found	Cause Value No. 5 (“Misdialed trunk prefix”)
500 Server Internal Error	Cause Value No. 8 (“Preemption”)
500 Server internal Error	Cause Value No. 9 (“Preemption-circuit reserved for reuse”)
486 Busy Here	Cause Value No. 17 (“user busy”)
480 Temporarily unavailable	Cause Value No. 18 (“no user responding”)
480 Temporarily unavailable	Cause Value No. 19 (“no answer from the user”)
480 Temporarily unavailable	Cause Value No. 20 (“subscriber absent”)
480 Temporarily unavailable	Cause Value No. 21 (“call rejected”)
410 Gone	Cause Value No. 22 (“number changed”)
No mapping	Cause Value No. 23 (“redirection to new destination”)
480 Temporarily unavailable	Cause Value No. 25 (“Exchange routing error”)
502 Bad Gateway	Cause Value No. 27 (“destination out of order”)
484 Address Incomplete	Cause Value No. 28 (“invalid number format (address incomplete”)
500 Server Internal Error	Cause Value No. 29 (“facility rejected”)
480 Temporarily unavailable	Cause Value No. 31 (“normal unspecified”) (Class default)
486 Busy here if Diagnostics Indicator includes the (CCBS indicator = “CCBS possible”) else 480 Temporarily unavailable	Cause Value in the Class 010 (resource unavailable, Cause Value No. 34)
500 Server Internal Error	Cause Value in the Class 010 (resource unavailable, Cause Value No. 38-47) (47 is class default)
500 Server Internal Error	Cause Value No. 50 (“requested facility not subscribed”)
500 Server Internal Error (SIP-I only)	Cause Value No. 55 (“incoming calls barred within CUG”)
500 Server Internal Error	Cause Value No. 57 (“bearer capability not authorized”)
500 Server Internal Error	Cause Value No. 58 (“bearer capability not presently”)
500 Server Internal Error	Cause Value No. 63 (“service option not available, unspecified”) (Class default)
500 Server Internal Error	Cause Value in the Class 100 (service or option not implemented Cause Value No. 65 - 79) (79 is class default)
500 Server Internal Error (SIP-I only)	Cause Value No. 87 (“user not member of CUG”)
500 Server Internal Error	Cause Value No. 88 (“incompatible destination”)
500 Server Internal Error (SIP-I only)	Cause Value No. 90 (“Non-existent CUG”)
404 Not Found	Cause Value No. 91 (“invalid transit network selection”)

←SIP MESSAGE	← REL CAUSE INDICATORS PARAMETER
500 Server Internal Error	Cause Value No. 95 (“invalid message”) (Class default)
500 Server Internal Error	Cause Value No. 97 (“Message type non-existent or not implemented”)
500 Server Internal Error	Cause Value No. 99 (“information element/parameter non-existent or not implemented”)
480 Temporarily unavailable	Cause Value No. 102 (“recovery on timer expiry”)
500 Server Internal Error	Cause Value No. 103 (“Parameter non-existent or not implemented, pass on”)
500 Server Internal Error	Cause Value No. 110 (“Message with unrecognized Parameter, discarded”)
500 Server Internal Error	Cause Value No. 111 (“protocol error, unspecified”) (Class default)
480 Temporarily unavailable	Cause Value No. 127 (“interworking unspecified”) (Class default)
NOTE 1: The 500 response will include a Reason header where the reason-params has the value preemption ;cause=4 ;text="Non-IP Preemption." NOTE 2: The 500 response will include a Reason header where the reason-params has the value preemption ;cause=4 ;text="Non-IP Preemption."	

[ITU-T Recommendation Q.1912.5, Section 6.11.4]

SIP-009190 When the terminating gateway receives an RSC from the ISUP network:

SIP-009190.a If the terminating gateway has already received an ACK for a previously sent 200 (OK) INVITE, then the terminating gateway **MUST** send a BYE.

SIP-009190.b If the terminating gateway has sent a 200 (OK) INVITE but has not received an ACK, then the terminating gateway **MUST** wait for the ACK before sending the BYE.

SIP-009190.c In all other cases, the terminating gateway **MUST** send a 500 (Server Internal Error) message response.

[ITU-T Recommendation Q.1912.5, Section 6.11.4]

SIP-009200 When the terminating gateway receives a GRS message from the ISUP network:

SIP-009200.a If the terminating gateway has already received an ACK for a previously sent 200 (OK) INVITE, the terminating gateway **MUST** send a BYE.

SIP-009200.b If the terminating gateway has sent a 200 (OK) INVITE but has not received an ACK, the terminating gateway **MUST** wait for the ACK before sending the BYE.

SIP-009200.c In all other cases, the terminating gateway MUST send a 500 (Server Internal Error) message response.

NOTE: One AS-SIP message MUST be sent for each call affected by the GRS.

[ITU-T Recommendation Q.1912.5, Section 6.11.4]

SIP-009210 When the terminating gateway receives a CGB with the Circuit Group Supervision Message Type indicator set to “hardware failure oriented” from the ISUP network:

SIP-009210.a If the terminating gateway has already received an ACK for a previously sent 200 (OK) INVITE, the terminating gateway MUST send a BYE.

SIP-009210.b If the terminating gateway has sent a 200 (OK) INVITE but has not received an ACK, the terminating gateway MUST wait for the ACK before sending the BYE.

SIP-009210.c In all other cases, the terminating gateway MUST send a 500 (Server Internal Error) message response.

NOTE: One AS-SIP message MUST be sent for each call affected by the CGB.

12.7.2.4 Terminating Gateway Maps AS-SIP Messages to ISUP Messages

BYE [ITU-T Recommendation Q.1912.5, Section 6.11.1]

SIP-009220 When the terminating gateway receives a BYE request, then the terminating gateway MUST send a REL onto the ISUP network.

SIP-009230 If the BYE has a Reason header field with a Q.850 cause value, the terminating gateway MAY map the Q.850 cause value from the Reason header field to the Cause Value field of the “REL Cause Indication” parameter, and set the Location field to “network beyond interworking point.”

SIP-009240 If the BYE does not have a Reason header field with a Q.850 cause value, then the terminating gateway MUST place cause value 16 (Normal Clearing) in the REL.

CANCEL [Q.1912.5, Section 6.11.1]

SIP-009250 When the terminating gateway receives a CANCEL request, the terminating gateway MUST send a REL to the ISUP network.

SIP-009260 If the CANCEL has a Reason header field with a Q.850 cause value, then the terminating gateway MAY map the Q.850 cause value from the Reason header field to the Cause Value field of the “REL Cause Indication” parameter, and set the Location field to “network beyond interworking point.”

SIP-009270 If the CANCEL does not have a Reason header field with a Q.850 cause value, then the terminating gateway MUST place cause value 31 (Normal Unspecified) in the REL.

12.7.2.5 ISUP Messages That Are Encapsulated by Terminating Gateway for Transparent Transport

No ISUP messages are encapsulated in AS-SIP messages for transport over the IP network.

12.7.2.6 Autonomous Release of Call by Terminating Gateway

[ITU-T Recommendation Q.1912.5, Section 6.11.3]

SIP-009280 [Table 12.7-3](#), 22/Q.1912.5, details the events that trigger an autonomous release by the terminating gateway resulting in the transmission of a BYE, 4xx, or 5xx to the IP network and a REL to the SS7 network.

SIP-009290 A Reason header field containing the (Q.850) cause value of the REL message MAY be included in the BYE request.

Table 12.7-3. 22/Q.1912.5

← SIP	TRIGGER EVENT	REL → CAUSE INDICATORS PARAMETER
484 Address Incomplete	Determination that insufficient digits were received. Applicable to overlap dialing, which is prohibited in this specification. When a UAS receives a request with a Request-URI that is incomplete, then UAS sends back 484 response.	Not applicable
480 Temporarily Unavailable	Congestion at the IWU.	Not applicable
BYE	ISUP procedures result in release after answer.	According to ISUP procedures
500 Server Internal Error	Call release due to the ISUP compatibility procedure (Note 1).	According to ISUP procedures
484 Address Incomplete	Call release due to expiry of T7 within the ISUP procedures.	According to ISUP procedures
480 Temporarily Unavailable	Call release due to expiry of T9 within the ISUP procedures.	According to ISUP procedures
480 Temporarily Unavailable	Other ISUP procedures result in release before answer..	According to ISUP procedures
NOTE: If the I-IWU receives unrecognized ISUP or BICC signaling information and determines that the call needs to be released based on the coding of the compatibility indicators, then see clause 2.9.5.2/Q.764 and clause 13.4.3/Q.1902.4.		

SECTION 13 RELEVANT TIMERS FOR THE TERMINATING GW AND ORIGINATING GW

13.1 ISUP TIMERS

ISUP T7 Timer

SIP-009300 When the terminating gateway receives an initial INVITE, the terminating gateway sets an ISUP T7 timer, maps the INVITE header fields to an IAM message, and sends the IAM onto the SS7 network.

SIP-009310 If an ACM is received from the ISUP network before expiration of the T7 timer, then the terminating gateway cancels the T7 timer, and

SIP-009310.a If the Called Party's Status of "BCI" parameter is "no indication" (bit 00) (i.e., early ACM), the terminating gateway creates a 183 (Session Progress) response, maps the "ACM" parameter fields to the SIP response header fields, and sends the response onto the IP network.

SIP-009310.b If the Called Party's Status of "BCI" parameter is "Subscriber free" (bit 01), the terminating gateway creates a 180 (Ringing) response, maps the "ACM" parameter fields to the SIP response header fields, and sends the response onto the IP network.

SIP-009320 If the ISUP T7 timer at the terminating gateway expires before the receipt of an ACM from the ISUP network, the terminating gateway MUST send a REL with cause code 102 "protocol error, recovery on timer expiry" to the ISUP network, and send a 504 response "gateway timeout" onto the IP network.

ISUP T11 Timer

SIP-009330 When the originating gateway receives an IAM from the ISUP network, the originating gateway sets the ISUP T11 timer, sets the SIP timer T1 (if the underlying transport protocol is unreliable (e.g., UDP)), creates an AS-SIP INVITE, and sends the INVITE onto the IP network.

SIP-009340 If the originating gateway receives a 180 (Ringing) response, the originating gateway MUST cancel the ISUP T11 timer, set the ISUP T9 timer, create an ACM (setting the Called Party's Status indicator of the BCI will have been set to "subscriber free" (bit 01), send the ACM onto the ISUP network, and transmit a ringing tone over the TDM bearer circuit to the caller.

SIP-009350 If the originating gateway receives a 183 (Session Progress) response, the originating gateway MUST take no action on the ISUP side.

SIP-009360 If the originating gateway does not receive a 180 (Ringing) response before the expiration of the ISUP T11 timer, the originating gateway **MUST** set timer T9, send an ACM with the Called Party's Status of the "BCI" parameter set to "no indication" (bit 00) onto the ISUP network, and transmit a ringing tone over the TDM bearer circuit to the caller.

ISUP T9 Timer (NOT Used by all ISUP Networks)

SIP-009370 Upon receipt of an ACM from the ISUP network, the terminating gateway sets an ISUP T9 timer and sends a 18x response onto the IP network.

SIP-009370.a If the ACM is an early ACM (i.e., the Called Party's Status of "BCI" parameter is "no indication" (bit 00), the SIP response is a 183 (Session Progress) response.

SIP-009370.b If the ACM has the Called Party's Status of "BCI" parameter is "Subscriber free" (bit 01), then the SIP response is 180 (Ringing) response.

SIP-009380 If an ANM is received from the ISUP network before the expiration of the ISUP T9 timer, the terminating gateway cancels the T9 timer, creates a 200 (OK) INVITE, and sends the 200 (OK) INVITE onto the IP network.

SIP-009390 If an ANM is NOT received from the ISUP network before the expiration of the ISUP T9 timer, the terminating gateway **SHOULD** send a 480 (Temporarily Unavailable) response onto the IP network and an REL message with cause value 19 (No Answer from the User) to the ISUP network.

13.2 SIP TIMERS

NOTE: This requirement **SHOULD NOT** be relevant to either the SBU network or the Classified network. When the originating gateway sends an AS-SIP INVITE over an Unreliable Transport Layer Protocol (i.e., UDP), the originating gateway **MUST** set SIP timer A with a default value of T1 equals 500 ms. [RFC 3261, Sections 17.1.1.1 and 17.1.1.2]If the timer expires before the originating gateway receiving a response to the INVITE, the originating gateway retransmits the INVITE. The originating gateway will repeat this process (with the T1 timer duration doubling each time) if it does not receive a response until seven transmissions of the INVITE and seven expirations of the timer at which time the originating gateway **MUST** send a CANCEL onto the IP network and send a REL over the ISUP network.

SIP-009400 When the originating gateway sends an AS-SIP INVITE over a reliable transport layer, then the originating gateway **MUST NOT** set SIP timer A.

SIP-009410 When the terminating gateway receives an ANM from the ISUP network (ITU ISUP, ANSI ISUP) or a CON (ITU ISUP only), and sends a 200 (OK) INVITE, the terminating gateway **MUST** set SIP timer T1. If the timer expires before the terminating gateway receiving

an ACK to the 200 (OK) response, the terminating gateway retransmits the 200 (OK) INVITE. The terminating gateway will repeat this process (with the T1 timer duration doubling each time) if it does not receive an ACK until seven transmissions of the INVITE and seven expirations of the T1 timer at which time the terminating gateway MUST send a BYE request onto the IP network and send a REL over the ISUP network.

SECTION 14 SIP REQUIREMENTS FOR INTER-WORKING AS-SIP SIGNALING APPLIANCES

14.1 GENERAL REQUIREMENTS

Interworking AS-SIP signaling appliances MUST comply with [Section 4](#), SIP Requirements for AS-SIP Signaling Appliances and AS-SIP EIs, as well as the additional general requirements enumerated here.

SIP-009420 When an interworking AS-SIP signaling appliance receives a request that contains a Require header field with one or more option-tags that it does not understand, then the interworking AS-SIP signaling appliance MUST return a 420 (Bad Extension) response. The response MUST include an Unsupported header field listing those option-tags the element did not understand (RFC 3261, Section 8.2.2.3).

SIP-009430 All outbound INVITEs generated by an interworking AS-SIP signaling appliance MUST include a Supported header with the option tag “100rel.”

14.2 METHODS

14.2.1 INVITE

SIP-009440 Interworking AS-SIP signaling appliances MUST support generating and receiving SIP INVITE requests.

SIP-009450 Interworking AS-SIP signaling appliances MUST comply with the requirements applicable to INVITE Client Transactions (see RFC 3261, Sections 17.1.1.1, 17.1.1.2, 17.1.1.3, 17.1.3, and 17.1.4) and INVITE Server Transactions (see RFC 3261, Sections 17.2.1, 17.2.3, and 17.2.4).

SIP-009460 Interworking AS-SIP signaling appliances MUST comply with the requirements of RFC 3261 Section 13.2.1, Creating the Initial INVITE, Section 13.2.2, Processing the INVITE Responses, and Section 13.3.1, Processing of the INVITE.

SIP-009470 Interworking AS-SIP signaling appliances MUST support generating and receiving SIP re-INVITES per RFC 3261, Section 14.

14.2.2 CANCEL

SIP-009480 Interworking AS-SIP signaling appliances MUST support generating and receiving SIP CANCEL requests and comply with RFC 3261, Section 9.

14.2.3 REGISTER

Not applicable.

14.2.4 OPTIONS

SIP-009490 Interworking AS-SIP signaling appliances **MUST** support generating and receiving SIP OPTIONS requests and **MUST** comply with the requirements for SIP OPTIONS set forth in RFC 3261, Section 11, Querying for Capabilities, which includes Sections 11.1, Construction of OPTIONS Request, and 11.2, Processing of OPTIONS Request.

14.2.5 BYE

SIP-009500 Interworking AS-SIP signaling appliances **MUST** support generating and receiving SIP BYE requests and **MUST** comply with the requirements of RFC 3261, Section 15, Terminating a Session.

14.2.6 ACK

SIP-009510 Interworking AS-SIP signaling appliances **MUST** support generating and receiving SIP ACK requests as defined in RFC 3261.

14.2.7 INFO

Inter-working AS-SIP signaling appliances are not required to support the use of the INFO method for purposes of inter-working between the AS-SIP network and the TDM network.

14.2.8 PRACK

SIP-009520 Interworking AS-SIP signaling appliances **MUST** support generating and receiving the SIP PRACK method as defined in RFC 3262.

SIP-009530 Interworking AS-SIP signaling appliances **MUST** support use of the option tag “100rel” with the Require header and Supported header, and **MUST** support the use of header fields RACK and RSeq as defined in RFC 3262.

14.2.9 UPDATE

SIP-009540 Interworking AS-SIP signaling appliances **MUST** support generating and receiving the SIP UPDATE method as defined in RFC 3311.

14.2.10 REFER

SIP-009550 Interworking AS-SIP signaling appliances **MUST** be capable of receiving/processing REFER requests, the Refer-To header, and the REFER event package as defined in RFC 3515.

SIP-009560 Interworking AS-SIP signaling appliances **MAY** generate REFER requests, the Refer-To header and the REFER event package when acting in the capacity of the transferor in the call transfer supplementary service.

SIP-009570 Interworking AS-SIP signaling appliances **MAY** support generating and receiving/processing the Referred-By header (RFC 3892).

14.2.11 SUBSCRIBE

SIP-009580 Interworking AS-SIP signaling appliances **MUST** support generating and receiving the SUBSCRIBE method for event notification (RFC 3265).

14.2.12 NOTIFY

SIP-009590 Interworking AS-SIP signaling appliances **MUST** support the NOTIFY method for event notification defined in RFC 3265. In particular, this specification uses the NOTIFY request in the call transfer supplementary service.

14.3 HEADER FIELDS

SIP-009600 Interworking AS-SIP signaling appliances **MUST**, in adherence with the enumerated RFCs, be capable of generating, receiving, and processing the following SIP headers (see RFC 3261, Section 20; RFC 3262; RFC 3265; RFC 3325; RFC 3326; RFC 3515; RFC 3891; RFC 4028; and RFC 4412 as modified herein):

- Accept
- Alert-Info
- Allow
- Allow-Events
- Call-ID
- Contact
- Content-Disposition
- Content-Length
- Content-Type
- Cseq
- Expires
- From
- Max-Forwards
- Min-Expires
- Min-SE
- Record-Route
- Refer-To
- P-Asserted-Identity
- Rack
- Reason
- Resource-Priority
- Retry-After
- RSeq
- Session-Expires
- Subscription-State
- Supported
- To
- Unsupported
- Via
- Warning

- Date
- Event
- Replaces
- Require
- Resource-Priority

SIP-009610 Interworking AS-SIP signaling appliances MAY be capable of receiving or processing the following SIP header:

Referred-By (RFC 3892)

SIP-009620 The From header MUST include a tag field as specified in RFC 3261, Section 19.3.

SIP-009630 The To header of a request that is part of a dialog MUST include a tag field as specified in RFC 3261, Section 19.3.

SIP-009640 Interworking AS-SIP signaling appliances MUST support the use of option tags for the Require, Supported, and Unsupported headers. Option-tags currently used in this specification are “replaces”, ”100rel”, “resource-priority”, “precondition”, and “timer.”

14.3.1 Route Header

SIP-009650 In the event the interworking AS-SIP signaling appliance is an SC, then:

SIP-009650.a When the interworking SC sends an initial AS-SIP INVITE to its local SBC intended for its SS, the interworking SC MUST add two Route header field values, which either takes the form of a route set comprising two Route headers where the first Route header is the sip uri for the SBC at the enclave and the second Route header is the sip uri for the SBC serving the SS, or takes the form of one Route header with two comma-separated field values.

NOTE: This requirement does not preclude the interworking SC from adding Route headers to SIP requests other than the initial INVITE; however, the interworking SC is only required to add Route headers to the initial INVITE.

SIP-009650.a.1 The format of the sip uri of the Route headers MUST consist of an alphanumeric identifier for the userinfo part and an IP address for the host name.

Example:

Route: <sip:SBCenc1@192.168.7.125;lr>

Route: <sip:SBCsdn3@195.117.2.1;lr>

or

Route: <sip:SBCenc1@192.168.7.125;lr>, <sip:SBCsdn3@195.117.2.1;lr>

SIP-009660 In the event the interworking AS-SIP signaling appliance is a SS, then:

SIP-009660.a When an interworking SS forwards an initial AS-SIP INVITE to a peer SS, then the interworking SS MUST add a route set comprising two Route headers where the first Route header is the SIP URI for the SBC that serves the interworking SS, and the second Route header is the SIP URI for the SBC serving the peer SS.

NOTE: This requirement does not preclude the interworking SS from adding Route headers to SIP requests other than the initial INVITE; however, the interworking SS is only required to add Route headers to the initial INVITE.

SIP-009660.a.1 The default format of the SIP URI for the Route header will consist of an alphanumeric identifier for the userinfo part and an IP address for the host name.

Example:

```
Route: <sip:SBCsdn3@192.168.100.100;lr>
Route: <sip:SBCsdn7@196.1.2.111;lr>
or
Route: <sip:SBCsdn3@192.168.100.100;lr>, <sip:SBCsdn7@196.1.2.111;lr>
```

SIP-009660.b When an interworking SS forwards an initial AS-SIP INVITE to a subtended SC, then the interworking SS MUST add a route set comprising two Route headers where the first Route header is the SIP URI for the SBC that serves the interworking SS, and the second Route header is the SIP URI for the SBC serving the subtended SC.

NOTE: This requirement does not preclude the interworking SS from adding Route headers to SIP requests other than the initial INVITE; however, the interworking SS is only required to add Route headers to the initial INVITE.

SIP-009660.b.1 The default format of the SIP URI for the Route header will consist of an alphanumeric identifier for the userinfo part and an IP address for the host name.

Example:

```
Route: <sip:SBCsdn7@192.168.88.50;lr>
Route: <sip:SBCenc25@188.2.44.3;lr>
or
Route: <sip:SBCsdn7@192.168.88.50;lr>, sip:SBCenc25@188.2.44.3;lr
```

14.3.2 Interworking AS-SIP Signaling Appliance and VIA Header Requirements

SIP-009670 When an interworking AS-SIP signaling appliance generates an outbound AS-SIP request, the interworking AS-SIP signaling appliance **MUST** add its own VIA header to the AS-SIP request.

SIP-009680 When an interworking AS-SIP signaling appliance receives a SIP response to be translated into TDM signaling, then the interworking AS-SIP signaling appliance operates as the UAC for SIP purposes.

SIP-009690 When an interworking AS-SIP signaling appliance receives an inbound SIP request to be translated into TDM signaling, then the AS-SIP signaling appliance operates as the UAS for SIP purposes.

SIP-009700 When an interworking AS-SIP signaling appliance generates a SIP response on behalf of a signaling message received from the TDM network, then before forwarding the SIP response the interworking AS-SIP signaling appliance **MUST** include the VIA headers received in the corresponding SIP request.

14.3.3 “CCA-ID” Parameter

SIP-009710 When an interworking AS-SIP signaling appliance operating as an originating gateway receives an IAM from the TDM network and sends an INVITE to another AS-SIP signaling appliance (SS or SC), then the interworking AS-SIP signaling appliance **MUST** add a “CCA-ID” parameter to the SIP URI of the Contact header populated with its unique identifier before forwarding the INVITE onward to the next AS-SIP signaling appliance.

14.4 RESPONSE CODES

SIP-009720 Interworking AS-SIP signaling appliances **MUST** support generating, receiving, and processing the provisional (1xx) response codes: 100 (Trying), 180 (Ringing), and 183 (Session Progress). [RFC 3261, Section 21.1, Provisional 1xx]

SIP-009730 Interworking AS-SIP signaling appliances **MUST** support generating and receiving/processing the successful (2xx) response codes: 200 (OK) (RFC 3261, Section 21.2, 200 OK) and 202 (Accepted) (RFC 3515).

SIP-009740 Interworking AS-SIP signaling appliances **MAY** be capable of operating as redirect servers and **MAY** support the following redirection (3xx) response codes: 300 (Multiple Choices), 301 (Moved Permanently), 302 (Moved Temporarily), and 305 (Use Proxy) (RFC 3261, Section 21.3, Redirection 3xxx).

SIP-009750 Interworking AS-SIP signaling appliances **MUST** support generating and receiving/processing the request failure (4xx) response codes: 400 (Bad Request), 401

(Unauthorized), 403 (Forbidden), 404 (Not Found), 405 (Method Not Allowed), 406 (Not Acceptable), 407 (Proxy Authentication Required), 408 (Request Timeout), 410 (Gone), 413 (Request Entity Too Large), 414 (Request-URI Too Long), 415 (Unsupported Media Type), 416 (Unsupported URI Scheme), 417 (Unknown Resource-Priority), 420 (Bad Extension), 421 (Extension Required), 422 (Session Interval Too Small), 423 (Interval Too Brief), 480 (Temporarily Unavailable), 481 (Call/Transaction Does Not Exist), 482 (Loop Detected), 483 (Too Many Hops), 484 (Address Incomplete), 485 (Ambiguous), 486 (Busy Here), 487 (Request Terminated), 488 (Not Acceptable Here), and 491 (Request Pending) (RFC 3261, Section 21.4, Request Failure 4xx).

SIP-009760 Interworking AS-SIP signaling appliances upon properly receiving a CANCEL request for an INVITE MUST first send a 200 (OK) response code to the CANCEL, and then follow up with a 487 (Request Terminated) response code to the INVITE.

SIP-009770 Interworking AS-SIP signaling appliances MUST support generating and receiving/processing the server failure (5xx) response codes: 500 (Server Internal Error), 501 (Not Implemented), 502 (Bad Gateway), 503 (Service Unavailable), 504 (Server Timeout), 505 (Version Not Supported), 513 (Message Too Large) [RFC 3261, Section 21.5, Server Failure 5xx], and 580 (Precondition Failure) (RFC 3312).

SIP-009780 Interworking AS-SIP signaling appliances MUST support generating and receiving/processing the global failures (6xx) response codes: 600 (Busy Everywhere), 603 (Decline), 604 (Does Not Exist Anywhere), and 606 (Not Acceptable) (RFC 3261, Section 21.6, Global Failures 6xx).

14.5 SIP PRECONDITIONS

See [Section 4.5](#), SIP Precondition, and [Section 4.5.2](#), Classified Network.

14.6 KBPS TRANSPARENT CALLS (CLEAR CHANNEL)

Interworking AS-SIP signaling appliances MUST comply with the requirements in [Section 4.7](#) Kbps Transparent Calls (Clear Channel).

14.7 TRANSPORT OF ROUTE CODE INFORMATION OVER AS-SIP

Interworking AS-SIP signaling appliances directly serving IP EIs MUST comply with the requirements in [Section 4.8](#), Transport of Route Code Information Over AS-SIP. In addition, interworking AS-SIP signaling appliances directly serving IP EIs MUST meet the requirements enumerated here.

SIP-009790 When an interworking AS-SIP signaling appliance receives an INVITE where the Request URI includes the “tgrp” parameter and “trunk-context” parameter and the INVITE is to be interworked into an ISUP IAM, then the interworking AS-SIP signaling appliance MUST conduct the following translation:

- If tgrp=hotline, then the Information Transfer Capability of the “User Service Information” parameter is set to Speech (“00000”).
- If tgrp=ccdata, then the Information Transfer Capability of the “User Service Information” parameter is set to Unrestricted Digital Information (“00000”).
- If tgrp=nosat N/A not defined.
- If tgrp=hotline-ccdata, then the Information Transfer Capability of the “User Service Information” parameter is set to Unrestricted Digital Information (“00000”).

SIP-009800 When an interworking AS-SIP signaling appliance receives an INVITE where the Request URI includes the “tgrp” parameter and “trunk-context” parameter and the INVITE is to be interworked into an ISDN Q.931 SETUP message, then the translation to be performed by the interworking AS-SIP signaling appliance is summarized in [Table 14.7-1](#), SIP tgrp to ISDN Q.931 Mapping.

Table 14.7-1. SIP tgrp to ISDN Q.931 Mapping

SIP TGRP=VALUE	Q.931 IE/ BEARER CAPABILITY
No label	Voice BC
tgrp=ccdata	56/64 Kbps circuit-mode data
tgrp=nosat	N/A – not defined
tgrp=hotline	Off-hook indicator of voice, speech BC
tgrp=hotline-ccdata	Off-hook indicator of data, 56/64 Kbps cmd BC
LEGEND:	
BC: Bearer Capability	Kbps: Kilobits per Second
cmd: Circuit Mode Data	N/A: Not Applicable
IE: Information Element	SIP: Session Initiation Value

14.8 KEEP-ALIVE TIMER REQUIREMENTS FOR INTERWORKING AS-SIP SIGNALING APPLIANCES

Interworking AS-SIP signaling appliances MUST comply with [Section 4.10](#), SIP Session Keep-Alive Timer, as well as the additional E1 requirements enumerated here.

SIP-009810 When an interworking AS-SIP signaling appliance receives an outbound request from the PSTN (i.e., the interworking AS-SIP signaling appliance is operating as an originating gateway) and the destination is NOT an IP EI directly served by the interworking AS-SIP signaling appliance, then the interworking AS-SIP signaling appliance MUST operate IAW the UAC behavior set forth in RFC 4028, Sections 7.1, Generating an Initial Session Refresh Request; 7.2, Processing a 2xx Response; 7.3, Processing a 422 Response; 7.4, Generating Subsequent Session Refresh Requests; and 10, Performing Refreshes (when responsible for performing the refresh).

SIP-009820 When an interworking AS-SIP signaling appliance receives an outbound request from the PSTN (i.e., the interworking AS-SIP signaling appliance is operating as an originating gateway) and the destination is an IP EI directly served by the interworking AS-SIP signaling appliance, then this document does NOT require the use of the keep-alive mechanism.

SIP-009830 When an interworking AS-SIP signaling appliance acting as a terminating gateway receives a call request from another AS-SIP signaling appliance, then the interworking AS-SIP signaling appliance MUST operate IAW the UAS behavior set forth in RFC 4028, Section 9, and RFC 4028, Section 10, Performing Refreshes (when responsible for performing the refresh).

SIP-009840 When an interworking AS-SIP signaling appliance receives an outbound request from a directly served IP EI and is the terminating gateway for the call request, then this document does NOT require the use of the keep-alive mechanism.

SECTION 15 PRECEDENCE AND PREEMPTION EXTENSIONS FOR INTERWORKING AS-SIP SIGNALING APPLIANCES

15.1 PRECEDENCE LEVEL COMMUNICATED OVER SIP SIGNALING

See [Section 6.1](#), Precedence Level Communicated Over SIP Signaling, for descriptions.

15.1.1 “Resource-Priority” Header Field

SIP-009850 Interworking AS-SIP signaling appliances MUST comply with the requirements in [Section 6.11](#), Resource-Priority Header Field.

15.1.2 Namespace

SIP-009860 Interworking AS-SIP signaling appliances MUST comply with the requirements in [Section 6.1.1.1](#), Namespace.

15.1.3 r-priority

SIP-009870 Interworking AS-SIP signaling appliances MUST comply with the requirements in [Section 6.1.1.4](#), r-priority.

15.2 REQUIREMENTS FOR INTER-WORKING AS-SIP SIGNALING APPLIANCES

Interworking AS-SIP signaling appliances directly serving IP EIs MUST comply with [Section 6.1.2](#), Requirements for SCs Serving IP EIs. All interworking AS-SIP signaling appliances MUST also comply with the requirements enumerated here.

15.2.1 Call Request Received From SS7 Network

SIP-009880 Whenever an interworking AS-SIP signaling appliance receives an ISUP message that requires translation into an INVITE, UPDATE, or REFER request then:

SIP-009880.a If the ISUP message contains a Multilevel Precedence and Preemption (MLPP) IE, the interworking AS-SIP signaling appliance MUST do the following:

- Translate the four network identity digits of the MLPP IE into the value for the corresponding network domain subfield IAW a translation table configured in the interworking AS-SIP signaling appliance. (An interworking AS-SIP signaling appliance always enters the ‘administrator configured’ default value [i.e., “uc” or “dsn” as the case may be] into the network domain subfield.)

- If the four network identity digits of the MLPP IE are the binary coded decimal 0000 (i.e., the MLPP equivalent of the default network domain ID), then the value to be placed into the r-priority field is determined from the MLPP precedence level bits using [Table 15.2-1](#). In the event the precedence level bits do not have an authorized value, then the r-priority field is given the value “0”.

Table 15.2-1. Table of Correspondence Between MLPP Bits in ISUP Message and Character Representation of Single Decimal Value for “r-priority” Field in Resource-Priority Header

PRECEDENCE LEVEL	MLPP PRECEDENCE LEVEL BITS	“RESOURCE-PRIORITY” R-PRIORITY VALUE
ROUTINE	0100	“0”
PRIORITY	0011	‘2’
IMMEDIATE	0010	‘4’
FLASH	0001	‘6’
FLASH-OVERRIDE	0000	‘8’

- If the four network identity digits of the MLPP IE are some number other than the binary coded decimal 0000, then the r-priority field is assigned the value “0”.
- Convert the hexadecimal value of the 3-octet MLPP service domain into a text string consisting of six characters, which is placed into the precedence-domain subfield.

IMPLEMENTATION NOTE: If the hexadecimal value in the 3-octet MLPP service domain is a value other than 0x000000, then it is acceptable for the interworking AS-SIP signaling appliance to convert the MLPP service domain to a precedence domain subfield having the text string “000000”.

SIP-009880.b If the ISUP message does not contain an MLPP IE, an interworking AS-SIP signaling appliance MUST assign the ‘administrator configured’ default value (“uc” or “dsn” as the case may be) to the network domain subfield, assign zero to the r-priority field, and assign “000000” to the precedence-domain subfield.

15.2.2 Call Request Intended for the SS7 Network

SIP-009890 When an interworking AS-SIP signaling appliance receives an INVITE, UPDATE, or REFER message from an AS-SIP signaling appliance intended for an EI on the TDM network, then the interworking AS-SIP signaling appliance MUST do the following:

- Set the network identity digits of the MLPP IE to the binary coded decimal value “0000”.
- Translate the value of the r-priority field of the Resource-Priority header to the equivalent MLPP precedence level bits (see [Table 15.2-1](#)).
- Set the service domain to 000000000000000000000000_{binary} (i.e., 0x000000).

SIP-009900 When an interworking AS-SIP signaling appliance receives a call signaling message from a directly served IP EI intended for a TDM EI (for which the AS-SIP signaling appliance is also the interworking gateway) and the corresponding ISUP message is an IAM, then the interworking AS-SIP signaling appliance MUST do the following:¹⁰⁰

- Set the network identity digits of the MLPP IE to the binary coded decimal value “0000”.
- Translate the precedence value of the call request to the equivalent MLPP precedence level bits. For example, in the case of an AS-SIP EI with P&P, use [Table 15.2-1](#) to translate between r-priority value and MLPP precedence level bits. In the case of a RO AS-SIP EI the INVITE will not include a Resource-Priority header and since by definition the RO AS-SIP EI only initiates routine calls the inter-working AS-SIP signaling appliance will set the corresponding MLPP level bits to ‘0100’ (routine).
- Set the service domain to 000000000000000000000000_{binary} (i.e., 0x000000).

15.3 OPTION TAG “RESOURCE-PRIORITY”

Interworking AS-SIP signaling appliances MUST comply with the requirements in [Section 6.1.3](#), Option Tag “resource-priority.”

SIP-009910 Interworking AS-SIP signaling appliances MUST support the option tag “resource-priority” for use with the Require header.

SIP-009920 The interworking AS-SIP signaling appliance MUST receive and accept a Require header field with the option tag “resource-priority” in the INVITE, UPDATE, and REFER messages. Interworking AS-SIP signaling appliances MUST NOT reject the message with a 420 (Bad Extension) response code, but rather it MUST accept the request and translate it into the appropriate TDM signaling message as required.

15.4 ERROR CONDITIONS

15.4.1 Improper Network-Domain, Priority Value, or Precedence-Domain

SIP-009930 When the interworking AS-SIP signaling appliance receives a SIP request with a Resource-Priority header intended for a destination on the TDM network and the SIP request either does not have a Require header or has a Require header but not the option tag “resource-priority,” then:

SIP-009930.a If the interworking AS-SIP signaling appliance does not recognize the value of the network-domain subfield of the namespace, then the network-domain subfield is treated as if it were set to the default value of the network-domain subfield (“uc” or “dsn”) and the r priority value is treated as if it were set to zero. If the

¹⁰⁰ In the case of a precedence call request from a directly served IP EI, the interworking AS-SIP signaling appliance MAY authenticate and authorize the caller.

precedence-domain subfield is either syntactically flawed or does not consist of the text string “000000,” then it is still treated as if it had the value “000000”.

NOTE: In the conversion to the precedence level IE, the network identity digits are “0000,” the MLPP precedence level bits are “0100” (ROUTINE), and the service domain is 0x000000.

SIP-009930.b If the interworking AS-SIP signaling appliance recognizes the value of the network-domain subfield of the namespace but the r priority field does not have an authorized value for the given network domain, then the r priority value is treated as if it were set to the lowest priority level.

If the precedence-domain subfield is either syntactically flawed or does not consist of the text string “000000,” then it is still treated as if it had the value “000000”.

SIP-009930.c If the interworking AS-SIP signaling appliance receives a namespace with a recognized network domain and an authorized r priority value where the precedence-domain subfield has a text string that is either syntactically invalid or does not consist of the text string “000000,” then the precedence-domain subfield is treated as if it were set to the text string “000000”.

SIP-009940 When the interworking AS-SIP signaling appliance receives a SIP request with a Resource-Priority header intended for a destination on the TDM network and the SIP request has a Require header field with an option tag “resource-priority,” then:

SIP-009940.a If the interworking AS-SIP signaling appliance does not recognize the value of the network-domain subfield of the namespace, then the interworking AS-SIP signaling appliance **MUST** reject the request with a 417 (Unknown Resource-Priority) response code.

SIP-009940.b If the interworking AS-SIP signaling appliance recognizes the value of the network domain subfield but the value of the r priority field is not valid for the given network domain, then the r priority value is treated as if it were set to the lowest priority level. If the precedence-domain subfield has a text string that is syntactically invalid or does not consist of the text string “000000,” then the precedence-domain subfield is treated as if it were set to “000000”.

SIP-009940.c If the interworking AS-SIP signaling appliance recognizes the value of the network domain and the r priority field has an authorized value for the network domain but the precedence-domain subfield has a text string that is syntactically invalid or does not consist of the text string “000000,” then the precedence-domain subfield is treated as if it were set to “000000”.

15.4.2 Authentication Failure

Interworking AS-SIP signaling appliances directly serving IP EIs MUST comply with [Section 6.1.4](#), Error Conditions, Authentication Failure subsection.

15.4.3 Authorization Failure

Interworking AS-SIP signaling appliances directly serving IP EIs MUST comply with [Section 6.1.4](#), Error Conditions, Authorization Failure subsection.

15.4.4 Insufficient Resources

SIP-009950 If an interworking AS-SIP signaling appliance receives an inbound ROUTINE call request over the IP network for a destination on the TDM network and the interworking AS-SIP signaling appliance has insufficient bandwidth-related resources (e.g., lack of circuit-switched trunk capacity for bearer traffic) to handle the call request, the interworking AS-SIP signaling appliance MUST reply with a 488 (Not Acceptable Here) response code and MUST include a Warning header with warning code 370 (Insufficient Bandwidth).

SIP-009960 If an interworking AS-SIP signaling appliance receives an inbound precedence call request (i.e., with precedence level PRIORITY or above) over the IP network for a destination on the TDM network and the interworking AS-SIP signaling appliance has insufficient bandwidth-related resources (e.g., lack of circuit-switched trunk capacity for bearer traffic) to handle the call request, and if there are insufficient existing calls (and/or call requests) of lower precedence whose removal would provide the necessary resources to support the pending call request, then:

SIP-009960.a The interworking AS-SIP signaling appliance MUST reply with a 488 (Not Acceptable Here) response code and SHOULD include a Warning header with warning code 370 (Insufficient Bandwidth), and

SIP-009960.b The AS-SIP signaling appliance serving the calling IP EI MUST arrange for a BPA to be played to the calling IP EI before terminating the call.

15.5 PRECEDENCE CALL RULES

Interworking AS-SIP signaling appliances directly serving IP EIs MUST comply with the requirements in [Section 6.2](#), Precedence Call Rules.

15.6 ASAC PREEMPTION REQUIREMENTS

SIP-009970 Interworking AS-SIP signaling appliances MUST comply with the requirements in [Section 6.4](#), ASAC Preemption Requirements.

15.6.1 Reason Header for Preemption

SIP-009980 Interworking AS-SIP signaling appliances MUST comply with the requirements in [Section 6.4.1](#), Reason Header for Preemption.

15.6.2 Preemption at the IP EI

15.6.2.1 General Preemption Rules for Behavior at IP EIs

SIP-010000 Interworking AS-SIP signaling appliances directly serving IP EIs MUST comply with the requirements in [Section 6.4.2.1](#), General Preemption Rules for Behavior at IP EI.

15.6.2.2 Interworking Signaling for BPA and BNEA

SIP-010010 When a precedence call request originating on the TDM network is blocked because of insufficient network resources on the IP network, then the interworking AS-SIP signaling appliance will receive a 488 (Not Acceptable Here) response that MUST include a “Warning” header with warning code 370 (Insufficient Bandwidth) with either no Reason header or a Reason header that does NOT include a preemption cause where the interworking AS-SIP signaling appliance MUST send a REL with Q.850 cause code 46 precedence call blocked (in the case of SS7 ISUP) or a Disconnect with Q.850 cause code 46 precedence call blocked (in the case of ISDN) onto the TDM network.

SIP-010020 When an interworking AS-SIP signaling appliance receives a precedence call request from the IP network that it translates and forwards onto the TDM network and the response from the TDM network is a REL with Q.850 cause code 46 precedence call blocked (in the case of SS7 ISUP) or a Disconnect with Q.850 cause code 46 precedence call blocked (in the case of ISDN), then the interworking AS-SIP signaling appliance MUST generate a 488 (Not Acceptable Here) response that MUST include a “Warning” header with warning code 370 (Insufficient Bandwidth) with no Reason header that it sends onto the IP network.

SIP-010030 When a precedence call request originating on the TDM network is blocked due to an endpoint preemption on the IP network, then the interworking AS-SIP signaling appliance will receive a 486 (Busy Here) response with either no Reason header or a Reason header that does NOT include a preemption cause where the interworking AS-SIP signaling appliance MUST send a REL with Q.850 cause code 46 precedence call blocked (in the case of SS7 ISUP) or a Disconnect with Q.850 cause code 46 precedence call blocked (in the case of ISDN) onto the TDM network.

SIP-010040 When a precedence call request originating on the TDM network is blocked due to a busy nonpreemptable endpoint on the IP network, then the interworking AS-SIP signaling appliance will receive a 480 (Temporarily Unavailable) response with either no Reason header or a Reason header that does NOT include a preemption cause where the interworking AS-SIP signaling appliance MUST send a REL with Q.850 cause code 46 precedence call

blocked (in the case of SS7 ISUP) or a Disconnect with Q.850 cause code 46 precedence call blocked (in the case of ISDN) onto the TDM network.

15.6.2.3 Required Behavior at Called IP EI When Active Call Is Preempted by Higher Precedence Call Request

SIP-010050 Interworking AS-SIP signaling appliances directly serving IP EIs MUST comply with the requirements in [Section 6.4.2.2](#), Required Behavior at Called IP EI When Active Call Is Preempted by Higher Precedence Call Request, when an active call is preempted by a higher precedence call request.

15.6.2.4 Implementing Preemption on Behalf of Called IP EIs

SIP-010060 Interworking AS-SIP signaling appliances directly serving IP EIs MUST comply with the requirements in [Section 6.4.2.3](#), Implementing Preemption on Behalf of Called IP EIs. In addition, interworking AS-SIP signaling appliances directly serving IP EIs MUST meet the following enumerated requirements.

15.6.2.4.1 Endpoint Preemption of an Active Call by Interworking SC or SC Component of Interworking SS

15.6.2.4.1.1 SC Serving IP EI (Other Than AS-SIP EI)

SIP-010070 When an SC performs endpoint preemption of an active call on behalf of a called IP EI (other than an AS-SIP EI) and the SC (or SS for which the SC is a component) is acting as an interworking gateway to the PSTN on behalf of the call to be preempted, the interworking SC (or SC in conjunction with the SS) MUST do the following:

SIP-010070.a Activate user signaling (i.e., preemption tone) at the local IP EI where the existing call is being preempted.

SIP-010070.b Send a REL with the cause value 8 “Preemption” or 9 “Preemption – Circuit reserved for reuse” to the SS7 network.

SIP-010070.c The EO serving the TDM EI will respond with an RLC.

SIP-010070.d When the local IP EI (other than an AS-SIP EI) goes on-hook, the interworking SC activates user signaling (i.e., precedence ringing tone) at the local IP EI and sends a 180 (Ringing) response to the remote SC or remote AS-SIP EI with P&P responsible for the precedence call request that initiated the endpoint preemption.¹⁰¹ ~~servicing the calling IP EI where the precedence call request has initiated the endpoint preemption or to the remote AS-SIP EI that initiated the precedence call request. A The remote SC~~ or remote AS-SIP EI with P&P will activate user signaling (i.e., precedence

¹⁰¹ By definition a RO AS-SIP EI does not initiate precedence calls.

ringback tone) ~~to~~ for the calling IP EI caller and the call setup for the precedence call request continues as usual. ~~A remote AS-SIP EI will activate user signaling (i.e., precedence ringback tone) and the call setup for the precedence call request continues as usual.~~

NOTE: If the precedence call request originated at a TDM EI, then the originating gateway will translate the 180 (Ringing) response into an ACM that is forwarded to the EO serving the calling TDM EI and the associated MG will generate the precedence ringback tone that is transmitted in the bearer to the TDM EI.

NOTE: If the precedence call request originated at a TDM EI and the interworking SC that is conducting the endpoint preemption is also the originating gateway for the precedence call request, then when the local IP EI goes on-hook the interworking SC (or SS if the SC is a component of the SS) will directly create and send the ACM over the SS7 network to the EO serving the calling TDM EI and the associated MG will generate the precedence ringback tone that is transmitted in the bearer to the TDM EI.

15.6.2.4.1.2 SC Serving AS-SIP EI

SIP-010080 [Required: AS-SIP EI with P&P] When an AS-SIP EI performs endpoint preemption of an active call and the serving SC (or SS for which the SC is a component) is acting as an interworking gateway to the PSTN on behalf of the call to be preempted, the AS-SIP EI MUST:

SIP-010080.a [Required: AS-SIP EI with P&P] Activate user signaling (i.e., preemption tone) and send a BYE request with a Reason header where the Reason-params has the value preemption ;cause=1 ;text="UA Preemption" to the serving SC.

SIP-010080.b The serving SC MUST do the following:

SIP-010080.b.1 Send a REL with the cause value 8 "Preemption" or 9 "Preemption -- Circuit reserved for reuse" to the SS7 network.

SIP-010080.b.2 The EO serving the TDM EI will respond with an RLC and the interworking SC sends a 200 (OK) response to the served AS-SIP EI, which terminates the preempted session.

SIP-010080.b.3 [Required: AS-SIP EI with P&P] When the AS-SIP EI goes on-hook the AS-SIP EI MUST do the following:

SIP-010080.b.3.a If a 200 (OK) response to the BYE has not been received yet, then terminate the bearer for the preempted session.

SIP-010080.b.3.b [Required: AS-SIP EI with P&P] Activate user signaling (i.e., precedence ringing tone) and send a 180 (Ringing) to the

~~remote SC or remote AS-SIP EI with P&P responsible for the precedence call request that initiated the endpoint preemption.¹⁰² serving the calling IP EI where the precedence call request has initiated the endpoint preemption or to the remote AS-SIP EI that initiated the precedence call request. A The remote SC or remote AS-SIP EI with P&P will activate user signaling (i.e., precedence ringback tone) to for the calling IP EI caller and the call setup for the precedence call request continues as usual. A remote AS-SIP EI will activate user signaling (i.e., precedence ringback tone) and the call setup for the precedence call request continues as usual.~~

NOTE: If the precedence call request originated at a TDM EI, then the originating gateway will translate the 180 (Ringing) into an ACM that is forwarded to the EO serving the calling TDM EI and the associated MG will generate the precedence ringback tone that is transmitted in the bearer to the TDM EI.

NOTE: If the precedence call request originated at a TDM EI and the SC that is serving the AS-SIP EI **with P&P** conducting the endpoint preemption is also the originating gateway for the precedence call request, then when the local AS-SIP EI goes on-hook and the interworking SC receives the 180 (Ringing) response, then the SC (or SS if the SC is a component of the SS) will directly create and send the ACM over the SS7 network to the EO serving the calling TDM EI, and the associated MG will generate the precedence ringback tone that is transmitted in the bearer to the TDM EI.

15.6.2.4.2 *Endpoint Preemption of an Inbound Call Request by Originating Gateway or AS-SIP EI Served by Originating Gateway*

15.6.2.4.2.1 SC Serving IP EI (Other Than AS-SIP EI)

SIP-010090 When an SC performs endpoint preemption of an inbound call request on behalf of a called IP EI (other than an AS-SIP EI) and the SC (or SS if the SC is a component) is acting as an originating gateway for the inbound call request to be preempted, the interworking SC (or SC with the SS) **MUST** do the following:

SIP-010090.a Send a termination message to the local IP EI to end the current inbound call request that is being preempted in favor of the new higher precedence call request. The termination message will terminate the ringing tone.

NOTE: There is no particular purpose for playing the preemption tone because the phone is on-hook.

SIP-010090.b Send a REL with the cause value 8 “Preemption” or 9 “Preemption – Circuit reserved for reuse” onto the SS7 network to the EO serving the calling TDM EI.

¹⁰² By definition a RO AS-SIP EI does not initiate precedence calls.

SIP-010090.c The EO serving the TDM EI will respond with an RLC.

SIP-010090.d The interworking SC activates user signaling (i.e., precedence ringing tone) at the local IP EI and a 180 (Ringing) response to the remote SC or remote AS-SIP EI with P&P responsible for the precedence call request that initiated the endpoint preemption.¹⁰³ ~~servicing the calling IP EI where the precedence call request has initiated the endpoint preemption or to the remote AS-SIP EI where the precedence call request has initiated the endpoint preemption. A The remote SC or remote AS-SIP EI with P&P will activate user signaling (i.e., precedence ringback tone) to-for the calling IP EI caller and the call setup for the precedence call request continues as usual. A remote AS-SIP EI will activate user signaling (i.e., precedence ringback tone) and the call setup for the precedence call request continues as usual.~~

NOTE: If the precedence call request originated at a TDM EI, then the originating gateway will translate the 180 (Ringing) response into an ACM that is forwarded to the EO serving the calling TDM EI and the associated MG will generate the precedence ringback tone that is transmitted in the bearer to the TDM EI.

NOTE: If the precedence call request originated at a TDM EI and the interworking SC that is conducting the endpoint preemption is also the originating gateway for the precedence call request, then when the local IP EI goes on-hook the interworking SC (or SS if the SC is a component of an SS) will directly create and send the ACM over the SS7 network to the EO serving the calling TDM EI, and the associated MG will generate the precedence ringback tone that is transmitted in the bearer to the TDM EI.

15.6.2.4.2.2 SC Serving AS-SIP EI

SIP-010100 [Required: AS-SIP EI with P&P] When an AS-SIP EI performs endpoint preemption of an inbound call request and the SC (or SS if the SC is a component of an SS) is acting as an originating gateway for the inbound call request to be preempted, the AS-SIP EI MUST do the following:

SIP-010100.a [Required: AS-SIP EI with P&P] Terminate the ringing tone and send a 486 (Busy Here) response with a Reason header where the Reason-params has the value preemption ;cause=1 ;text="UA Preemption" to the serving SC.

NOTE: There is no particular purpose for playing the preemption tone because the phone is on-hook.

SIP-010100.b The interworking SC (or SS if the SC is a component of an SS) MUST do the following:

¹⁰³ By definition a RO AS-SIP EI does not initiate precedence calls.

SIP-010100.b.1 Send a REL with the cause value 8 “Preemption” or 9 “Preemption -- Circuit reserved for reuse” onto the SS7 network to the EO serving the calling TDM EI.

SIP-010100.b.2 The EO serving the TDM EI will respond with an RLC and the SC sends an ACK to the served AS-SIP EI.

SIP-010100.c **[Required: AS-SIP EI with P&P]** Upon receipt of the ACK, the AS-SIP EI MUST do the following:

SIP-010100.c.1 **[Required: AS-SIP EI with P&P]** Activate user signaling (i.e., precedence ringing tone) and send a 180 (Ringing) response to the remote SC or remote AS-SIP EI with P&P responsible for the precedence call request that initiated the endpoint preemption.¹⁰⁴ ~~servicing the calling IP EI where the precedence call request has initiated the endpoint preemption or to the remote AS-SIP EI where the precedence call request has initiated the endpoint preemption. A~~ The remote SC or remote AS-SIP EI with P&P will activate user signaling (i.e., precedence ringback tone) ~~to for the calling IP EI caller~~ and the call setup for the precedence call request continues as usual. ~~A remote AS-SIP EI will activate user signaling (i.e., precedence ringback tone) and the call setup for the precedence call request continues as usual.~~

NOTE: If the precedence call request originated at a TDM EI, then the originating gateway will translate the 180 (Ringing) response into an ACM that is forwarded to the EO serving the calling TDM EI, and the associated MG will generate the precedence ringback tone that is transmitted in the bearer to the TDM EI.

NOTE: If the precedence call request originated at a TDM EI and the SC that is serving the AS-SIP EI conducting the endpoint preemption is also the originating gateway for the precedence call request, then when the local AS-SIP EI goes on-hook and the interworking SC receives the 180 (Ringing) response, then the SC (or SS if the SC is a component of the SS) will directly create and send the ACM over the SS7 network to the EO serving the calling TDM EI, and the associated MG will generate the precedence ringback tone that is transmitted in the bearer to the TDM EI.

15.6.2.4.3 Endpoint Preemption of an Outbound Call Request by Terminating Gateway or AS-SIP EI Served by Terminating Gateway

15.6.2.4.3.1 SC Serving IP EI (Other Than AS-SIP EI)

SIP-010110 When an SC performs endpoint preemption of an outbound call request on behalf of a called IP EI, and the SC (or SS if SC is a component of an SS) is acting as a terminating gateway for the outbound call request to be preempted, the SC (or SC in conjunction with an SS) MUST do the following:

¹⁰⁴ By definition a RO AS-SIP EI does not initiate precedence calls.

SIP-010110.a Interrupt current user signaling associated with the outbound call request (e.g., ringback) and activate user signaling (i.e., preemption tone) at the local IP EI where the existing call is being preempted.

SIP-010110.b Send a REL with the cause value 8 “Preemption” or 9 “Preemption – Circuit reserved for reuse” onto the SS7 network.

SIP-010110.c The EO serving the TDM EI will respond with an RLC.

SIP-010110.d Upon the receiver going on-hook, the local interworking SC will continue the call setup for the higher precedence call by activating user signaling at the local IP EI (i.e., precedence ringing tone), and sending a 180 (Ringing) response to the remote SC or remote AS-SIP EI with P&P; responsible for the precedence call request that initiated the endpoint preemption.¹⁰⁵ ~~and so forth.~~

NOTE: If the precedence call request originated at a TDM EI, then the originating gateway will translate the 180 (Ringing) response into an ACM that is forwarded to the EO serving the calling TDM EI and the associated MG will generate the precedence ringback tone that is transmitted in the bearer to the TDM EI.

NOTE: If the precedence call request originated at a TDM EI and the interworking SC that is conducting the endpoint preemption is also the originating gateway for the precedence call request, then when the local IP EI goes on-hook the interworking SC (or SS if the SC is a component of an SS) will directly create and send the ACM over the SS7 network to the EO serving the calling TDM EI, and the associated MG will generate the precedence ringback tone that is transmitted in the bearer to the TDM EI.

15.6.2.4.3.2 SC Serving AS-SIP EI

SIP-010120 [Required: AS-SIP EI with P&P] When an AS-SIP EI performs endpoint preemption of an outbound call request, and the SC (or SS if the SC is a component of an SS) is acting as a terminating gateway for the outbound call request to be preempted, the AS-SIP EI MUST do the following:

SIP-010120.a [Required: AS-SIP EI with P&P] Interrupt current user signaling associated with the outbound call request (e.g., ringback), activate user signaling (i.e., preemption tone), and send.

SIP-010120.a.1 [Required: AS-SIP EI with P&P] If an early dialog has been established, send a BYE or CANCEL request with a Reason header where the Reason-params has the value `preemption;cause=1 ;text=“UA Preemption”` to the serving SC.

¹⁰⁵ By definition a RO AS-SIP EI does not initiate precedence calls.

SIP-010120.a.2 [Required: AS-SIP EI with P&P] If an early dialog has not been established, send a CANCEL request with a Reason header where the Reason-params has the value `preemption;cause=1;text="UA Preemption"` to the serving SC.

SIP-010120.b The serving SC (or SS if the SC is a component of an SS) MUST do the following:

SIP-010120.b.1 Send a REL with the cause value 8 "Preemption" or 9 "Preemption -- Circuit reserved for reuse" onto the SS7 network.

SIP-010120.b.2 The EO serving the TDM EI will respond with an RLC, and the SC sends a 200 (OK) response to the AS-SIP EI in response to a BYE or a 200 (OK) response in response to a CANCEL followed by a 487 (Request Terminated) response to the INVITE.

NOTE: The AS-SIP EI will send an ACK to the SC if the SC sends a 487 response.

SIP-010120.c [Required: AS-SIP EI with P&P] Upon the receiver going on-hook, the AS-SIP EI MUST do the following:

SIP-010120.c.1 [Required: AS-SIP EI with P&P] Continue the call setup for the higher precedence call by activating user signaling (i.e., precedence ringing tone); and sending a 180 (Ringing) response to the remote SC or remote AS-SIP EI with P&P responsible for the precedence call request that initiated the endpoint preemption.¹⁰⁶; and so forth.

NOTE: If the precedence call request originated at a TDM EI, then the originating gateway will translate the 180 (Ringing) response into an ACM that is forwarded to the EO serving the calling TDM EI, and the associated MG will generate the precedence ringback tone that is transmitted in the bearer to the TDM EI.

NOTE: If the precedence call request originated at a TDM EI and the SC that is serving the AS-SIP EI conducting the endpoint preemption is also the originating gateway for the precedence call request, then when the local AS-SIP EI goes on-hook and the interworking SC receives the 180 (Ringing) response, then the SC (or SS if the SC is a component of the SS) will directly create and send the ACM over the SS7 network to the EO serving the calling TDM EI, and the associated MG will generate the precedence ringback tone that is transmitted in the bearer to the TDM EI.

15.6.3 Network Preemption

The Network Preemption requirements set forth in this section specifically cover the network preemption scenarios where the interworking AS-SIP signaling appliance either:

¹⁰⁶ By definition a RO AS-SIP EI does not initiate precedence calls.

1. Directly serves an IP EI that is the source of the precedence level call request for which preemption is sought and as the terminating gateway for the precedence level call request for which preemption is sought, or
2. Operates as the originating gateway for the precedence level call request for which preemption is sought and directly serves an IP EI that is the destination of the precedence level call request for which preemption is sought.
3. Operates as the originating gateway for the precedence level call request for which preemption is sought, or
4. Operates as the terminating gateway for the precedence level call request for which preemption is sought.

15.6.3.1 Circumstances Under Which an Interworking AS-SIP Signaling Appliance Performs Network Preemption

SIP-010130 Interworking AS-SIP signaling appliances directly serving IP EIs **MUST** comply with the requirements in [Section 6.4.3.1](#), Circumstances Under Which an AS-SIP Signaling Appliance Performs Network Preemption.

15.6.3.2 Implementing the Network Preemption

SIP-010140 Interworking AS-SIP signaling appliances directly serving IP EIs **MUST** comply with the requirements in [Section 6.4.3.2](#), Implementing the Network Preemption. In addition, interworking AS-SIP signaling appliances directly serving IP EIs **MUST** meet the following enumerated requirements.

15.6.3.2.1 Network Preemption of Active Call

15.6.3.2.1.1 EI > CCS7 .> Sig Appl.> EI

SIP-010150 When an interworking SC (or SS if the SC is a component of an SS) performs a network preemption of an active call (where the interworking SC directly serves an IP EI (other than an AS-SIP EI) where the call is to be preempted AND serves as the interworking gateway to the TDM network on behalf of the call to be preempted), then the interworking SC (or SS if the SC is a component of an SS) **MUST** do the following:

SIP-010150.a Activate the preemption tone at the local IP EI for a minimum of 3 seconds, and then send a termination message to the local IP EI.

SIP-010150.b Send a REL with the cause value 8 “Preemption” or 9 “Preemption – Circuit reserved for reuse” onto the SS7 network.

SIP-010150.c EO serving the TDM EI will respond with an RLC.

SIP-010160 When an interworking SC (or SS if the SC is a component of an SS) performs a network preemption of an active call (where the interworking SC directly serves an AS-SIP EI where the call is to be preempted AND serves as the interworking gateway to the TDM network on behalf of the call to be preempted), then the interworking SC (or SS if the SC is a component of an SS) MUST do the following:

SIP-010160.a Send a SIP BYE request with a Reason header where the Reason-params has the value preemption ;cause=5 ;text="Network Preemption") to the served AS-SIP EI. In the case of an AS-SIP EI with P&P the AS-SIP EI with P&P activates the preemption tone for a minimum of 3 seconds, sends a 200 (OK) response to the SC, and terminates the session. In the case of a RO AS-SIP EI the RO AS-SIP EI sends a 200 (OK) response to the SC and terminates the session.

SIP-010160.b Send a REL with the cause value 8 "Preemption" or 9 "Preemption -- Circuit reserved for reuse" onto the SS7 network.

SIP-010160.c The EO serving the TDM EI will respond with an RLC.

15.6.3.2.2 Network Preemption of an Inbound Call Request

SIP-010170 When an interworking SC (or SS if the SC is a component of an SS) performs a network preemption of an inbound call request to a directly served IP EI (other than an AS-SIP EI) (receiver is on-hook) and is also acting as an originating gateway for the inbound call request to be preempted, the interworking SC (or SS if the SC is a component of an SS) MUST do the following:

SIP-010170.a Send a REL with the cause value 8 "Preemption" or 9 "Preemption -- Circuit reserved for reuse" onto the SS7 network.

SIP-010170.b The EO serving the TDM EI will respond with an RLC.

SIP-010170.c Conduct call termination with the local IP EI that deactivates the ringing tone.

SIP-010180 When an interworking SC (or SS if the SC is a component of an SS) performs a network preemption of an inbound call request to a directly served AS-SIP EI (i.e., receiver is on-hook) and is also acting as an originating gateway for the inbound call request to be preempted, the interworking SC (or SS if the SC is a component of an SS) MUST do the following:

SIP-010180.a Send a REL with the cause value 8 "Preemption" or 9 "Preemption -- Circuit reserved for reuse" onto the SS7 network.

SIP-010180.b The EO serving the TDM EI will respond with an RLC.

SIP-010180.c Send a SIP BYE request or CANCEL request, as appropriate, with a Reason header where the Reason-params has the value preemption ;cause=5

;text="Network Preemption") to the AS-SIP EI. The AS-SIP EI deactivates the ringing tone, sends a 200 (OK) response, and terminates the inbound call request.

15.6.3.2.3 Network Preemption of an Outbound Call Request

SIP-010190 When an interworking SC (or SS if the SC is a component of an SS) performs a network preemption of an outbound call request from a directly served IP EI (other than an AS-SIP EI) that has not received a 2xx response and is also acting as a terminating gateway for the outbound call request being preempted, the interworking SC (or SS if the SC is a component of an SS) MUST do the following:

SIP-010190.a Send a REL with the cause value 8 "Preemption" or 9 "Preemption – Circuit reserved for reuse" onto the SS7 network.

SIP-010190.b The EO serving the TDM EI will respond with an RLC.

SIP-010190.c Deactivate any user signaling (e.g., ringback), activate the preemption tone for a minimum of 3 seconds, and then conduct call termination.

SIP-010200 When an interworking SC (or SS if the SC is a component of an SS) performs a network preemption of an outbound call request from a directly served AS-SIP EI that has not received a 2xx response and is also acting as a terminating gateway for the outbound call request being preempted, the interworking SC (or SS if the SC is a component of an SS) MUST do the following:

SIP-010200.a Send a REL with the cause value 8 "Preemption" or 9 "Preemption – Circuit reserved for reuse" onto the SS7 network.

SIP-010200.b The EO serving the TDM EI will respond with an RLC.

SIP-010200.c Send a 488 (Not Acceptable Here) response code that SHOULD include a Warning header field with warning code 370 (Insufficient Bandwidth) with a Reason header where the Reason-params has the value preemption;cause=5 ;text="Network Preemption" to the AS-SIP EI. An AS-SIP EI with P&P deactivates any user signaling (e.g., ringback), activates the preemption tone for a minimum of 3 seconds, responds to the SC with an ACK, and terminates the call request. A RO AS-SIP EI deactivates any user signaling (e.g., ringback), responds to the SC with an ACK, and terminates the call request.

15.6.3.2.4 Network Preemption of Call Request (Interworking AS-SIP Signaling Appliance does not Directly Serve One of the Preempted IP EIs)

SIP-010210 When an interworking AS-SIP signaling appliance acting as an originating gateway for a call request intended for a remote EI not directly served by the interworking AS-SIP signaling appliance initiates a preemption of the call request (for which a 2xx response has not been received yet), the interworking AS-SIP signaling appliance MUST do the following:

SIP-010210.a If an early dialog has been established, send a BYE or CANCEL request to the AS-SIP signaling appliance directly serving the called IP EI in the preempted call request or to the AS-SIP EI in the preempted call request.

SIP-010210.a.1 If the preemption was caused by a lack of network resources on the IP side (e.g., call count at provisioned threshold), then the BYE or CANCEL request MUST include a Reason header where the Reason-params has the value preemption ;cause=5 ;text="Network Preemption."

SIP-010210.a.2 If the preemption was caused by a lack of network resources on the TDM side (e.g., all TDM circuits on interworking gateway are busy), then the BYE or CANCEL request MUST have a Reason header where the Reason-params has the value preemption ;cause=4 ;text="Non-IP Preemption."

SIP-010210.b If an early dialog has NOT been established, then if a provisional response has been received already or if not, then upon receipt of a provisional response send a CANCEL¹⁰⁷ request to the AS-SIP signaling appliance directly serving the called IP EI in the preempted call request or to the AS-SIP EI in the preempted call request.

SIP-010210.b.1 If the preemption was caused by a lack of network resources on the IP side (e.g., call count at provisioned threshold), then the CANCEL request MUST include a Reason header where the Reason-params has the value preemption ;cause=5 ;text="Network Preemption."

SIP-010210.b.2 2 If the preemption was caused by a lack of network resources on the TDM side (e.g., all TDM circuits on interworking gateway are busy), then the CANCEL request MUST include a Reason header where the Reason-params has the value preemption ;cause=4 ;text="Non-IP Preemption."

SIP-010210.c The interworking AS-SIP signaling appliance will receive a 200 (OK) response to the BYE or CANCEL request. In the case of a CANCEL request, the interworking AS-SIP signaling appliance will usually receive a 487 (Request Terminated) response to the INVITE.

SIP-010210.d Send a REL with the cause value 8 "Preemption" or 9 "Preemption – Circuit reserved for reuse" onto the SS7 network.

SIP-010210.e The EO serving the TDM EI will respond with an RLC.

SIP-010220 When an interworking AS-SIP signaling appliance performs a network preemption of a call request where the interworking AS-SIP signaling appliance is acting as a terminating gateway on behalf of the call request to be preempted AND does not directly serve an IP EI

¹⁰⁷ If the interworking AS-SIP signaling appliance has not received any provisional response, it MUST wait to receive a provisional response before sending the CANCEL. In the event the first response is a final response or a provisional response that creates an early dialog (i.e., 101-199 with a tag in the To header), then the interworking AS-SIP signaling appliance sends a BYE request instead of a CANCEL.

where the call is to be preempted, then the interworking AS-SIP signaling appliance MUST do the following:

SIP-010220.a Send a 488 (Not Acceptable Here) response code that SHOULD include a Warning header with warning code 370 (Insufficient Bandwidth) over the IP network toward the AS-SIP signaling appliance directly serving the IP EI where the call request is being preempted or to the AS-SIP EI where the call request is being preempted.¹⁰⁸

SIP-010220.a.1 If the preemption was caused by a lack of network resources on the IP side (e.g., call count at provisioned threshold), then the 488 response MUST include a Reason header where the Reason-params has the value `preemption ;cause=5 ;text="Network Preemption."`

SIP-010220.a.2 If the preemption was caused by a lack of network resources on the TDM side (e.g., all TDM circuits on interworking gateway are busy), then the 488 response MUST include a Reason header where the Reason-params has the value `preemption ;cause=4 ;text="Non-IP Preemption."`

SIP-010220.b The interworking AS-SIP signaling appliance will receive an ACK response to the 488 (Not Acceptable Here) response.

SIP-010220.c Send a REL with the cause value 8 "Preemption" or 9 "Preemption -- Circuit reserved for reuse" onto the SS7 network.

SIP-010220.d The EO serving the TDM EI will respond with an RLC.

15.6.3.2.5 Network Preemption of an Active Call (Interworking AS-SIP Signaling Appliance Receives REL)

SIP-010230 When an interworking AS-SIP signaling appliance receives a REL with a cause value of 8 "Preemption" or 9 "Preemption – Circuit reserved for reuse" for an active call and does NOT directly serve an IP EI where the call is to be preempted, the interworking AS-SIP signaling appliance MUST do the following:

SIP-010230.a Send an RLC response onto the SS7 network.

SIP-010230.b Send a BYE request with a Reason header with a reason-value of `preemption ;cause=4 ;text="Non-IP Preemption"` intended for either the AS-SIP signaling appliance directly serving the IP EI where the call is to be preempted or to the AS-SIP EI where the call is to be preempted.

SIP-010230.c The interworking gateway will receive a 200 (OK) response.

¹⁰⁸ Call has not progressed to the point that the interworking AS-SIP signaling appliance has received an ACK to a 200 OK INVITE.

SIP-010240 When an interworking AS-SIP signaling appliance receives a REL with a cause value of 8 “Preemption” or 9 “Preemption – Circuit reserved for reuse” for an active call AND directly serves the IP EI where the call is to be preempted, then the interworking AS-SIP signaling appliance MUST do the following:

SIP-010240.a Send an RLC response onto the SS7 network.

SIP-010240.b In the case of a served IP EI (other than an AS-SIP EI) activate the preemption tone at the local IP EI for a minimum of 3 seconds, and then send a termination message to the local IP EI.

SIP-010240.c In the case of a served AS-SIP EI, send a SIP BYE request with a Reason header where the Reason-params has the value preemption ;cause=4 ;text=“Non-IP Preemption.” An AS-SIP EI with P&P activates the preemption tone for a minimum of 3 seconds, sends a 200 (OK) response to the SC, and terminates the session. A RO AS-SIP EI sends a 200 (OK) response to the SC and terminates the session.

15.6.3.2.6 Network Preemption of Call Request (Interworking AS-SIP Signaling Appliance Receives REL)

SIP-010250 When an interworking AS-SIP signaling appliance is acting as an originating gateway for a call request (call request originated on TDM network) for which the interworking AS-SIP signaling appliance receives a REL with a cause value of 8 “Preemption” or 9 “Preemption – Circuit reserved for reuse,” and the interworking AS-SIP signaling appliance does NOT directly serve an IP EI where the call is to be preempted, and has not received a 2xx response yet, the interworking AS-SIP signaling appliance MUST do the following:

SIP-010250.a Send an RLC response onto the SS7 network.

SIP-010250.b If an early dialog has been established, send a BYE or CANCEL request with a Reason header where the Reason-params has the value preemption ;cause=4 ;text=“Non-IP Preemption” either to the AS-SIP signaling appliance directly serving the called IP EI in the preempted call request or to the AS-SIP EI in the preempted call request.

SIP-010250.c 3 If an early dialog has not been established, then if a provisional response has already been received, or if not, then upon receipt of a provisional response, send a CANCEL¹⁰⁹ request with a Reason header where the Reason-params has the value preemption ;cause=4 ;text=“Non-IP Preemption” either to the AS-SIP signaling appliance

¹⁰⁹ If the interworking AS-SIP signaling appliance has not received any provisional response, it MUST wait to receive a provisional response before sending the CANCEL. In the event the first response is a final response or a provisional response that creates an early dialog (i.e., 101-199 with a tag in the To header), then the interworking AS-SIP signaling appliance sends a BYE request instead of a CANCEL.

directly serving the called IP EI in the preempted call request or to the AS-SIP EI in the preempted call request.

SIP-010250.d The interworking AS-SIP signaling appliance will receive a 200 (OK) response to the BYE or CANCEL request. The interworking AS-SIP signaling appliance will usually receive a 487 (Request Terminated) response to the INVITE.

SIP-010260 When an interworking AS-SIP signaling appliance is acting as a terminating gateway for a call request for which the interworking AS-SIP signaling appliance receives a REL with a cause value of 8 “Preemption” or 9 “Preemption – Circuit reserved for reuse,” and the interworking AS-SIP signaling appliance does NOT directly serve an IP EI where the call is to be preempted, the interworking AS-SIP signaling appliance MUST do the following:

SIP-010260.a Send an RLC response onto the SS7 network.

SIP-010260.b Send a 488 (Not Acceptable Here) response code that SHOULD include a Warning header with warning code 370 (Insufficient Bandwidth) with a Reason header where the Reason-params has the value `preemption;cause=4;text=“Non-IP Preemption”` over the IP network toward the AS-SIP signaling appliance directly serving the IP EI where the call request is being preempted or to the AS-SIP EI where the call request is being preempted.

SIP-010270 When an interworking AS-SIP signaling appliance receives a REL with a cause value of 8 “Preemption” or 9 “Preemption – Circuit reserved for reuse” for a call request initiated by a TDM EI and where the destination is an IP EI directly served by the interworking AS-SIP signaling appliance, then the interworking AS-SIP signaling appliance MUST do the following:

SIP-010270.a Send an RLC response onto the SS7 network.

SIP-010270.b In the case of an IP EI (other than an AS-SIP EI) deactivate the ringing tone at the local IP EI, and conduct call termination with the local IP EI.

SIP-010270.c In the case of an AS-SIP EI, send a SIP BYE request or CANCEL request, as appropriate, with a Reason header where the Reason-params has the value `preemption;cause=4;text=“Non-IP Preemption”`). The AS-SIP EI deactivates the ringing tone, sends a 200 (OK) response to the SC, and terminates the session.

SIP-010280 When an interworking AS-SIP signaling appliance receives a REL with a cause value of 8 “Preemption” or 9 “Preemption – Circuit reserved for reuse” for a call request initiated by a directly served IP EI, then the interworking AS-SIP signaling appliance MUST do the following:

SIP-010280.a Send an RLC response onto the SS7 network.

SIP-010280.b In the case of an IP EI (other than an AS-SIP EI) deactivate user signaling (e.g., ringback), activate the preemption tone for a minimum of 3 seconds, and then conduct call termination.

SIP-010280.c In the case of an AS-SIP EI, send a 488 (Not Acceptable Here) response with a Reason header where the Reason-params has the value preemption ;cause=4 ;text="Non-IP Preemption"). An AS-SIP EI with P&P deactivates user signaling (e.g., ringback), activates the preemption tone for a minimum of 3 seconds, sends an ACK to the SC, and terminates the call request. A RO AS-SIP EI deactivates user signaling (e.g., ringback), sends an ACK to the SC, and terminates the call request.

SECTION 16 SUPPLEMENTARY SERVICES

16.1 INTRODUCTION

Many calling features are traditional to the TDM network and the PSTN. Within the PSTN, some calling features are required by law and regulated by the FCC. This specification is used within the context of a private network, and thus, is not necessarily subject to the same laws and regulations.

It should be noted that the call flows depicted in this interworking section focus on the signaling-related functions and interfaces supported by the signaling appliances interfacing with the UC WAN and the translation of the signaling flow between the TDM signaling domain and the AS-SIP signaling domain. In every case, the primary call flow diagram and description depicts and details the signaling flow across the UC WAN but not the signaling across the LAN between the AS-SIP signaling appliance serving an IP EI and the IP EI. This is appropriate for all non-AS-SIP EIs (e.g., SIP, H.323, proprietary EIs). In some cases, a secondary call flow diagram is provided that depicts AS-SIP signaling down to the AS-SIP EI to enhance the reader's understanding of the given call flow.

The call flow diagrams assume the two-tier hierarchical architecture where for incoming or outgoing calls to be established across the UC WAN, the SC at a B/P/C/S exchanges its AS-SIP messages with an assigned SS.

Call features 1, 2, 3, 4, and 5 are required for the near-term open loop architecture. In addition, the near-term open loop architecture calls for AS-SIP to support the fax and modem services per [Section 11](#), Modem on IP Networks.

16.2 POINT-TO-POINT CALL

Signaling requirements for point-to-point calls are described for the following three call conditions:

- No precondition.
- Segmented precondition.
- End-to-end precondition.

16.2.1 IP-to-IP Call Type

See [Section 9.2.1](#), IP-to-IP Call Type.

16.2.2 TDM Bridging Call Type

16.2.2.1 TDM Bridging Call Type (No Preconditions)

SIP-010290 [Figure 16.2-1](#), Successful Basic TDM Bridging Call (No Preconditions), depicts the sequence of AS-SIP and ISUP messages between the end office serving TDM Party A and the end office serving TDM Party B used to establish and then tear down a telephony session traversing the IP WAN. The call flow diagram depicts reliable provisional responses but not the use of preconditions.

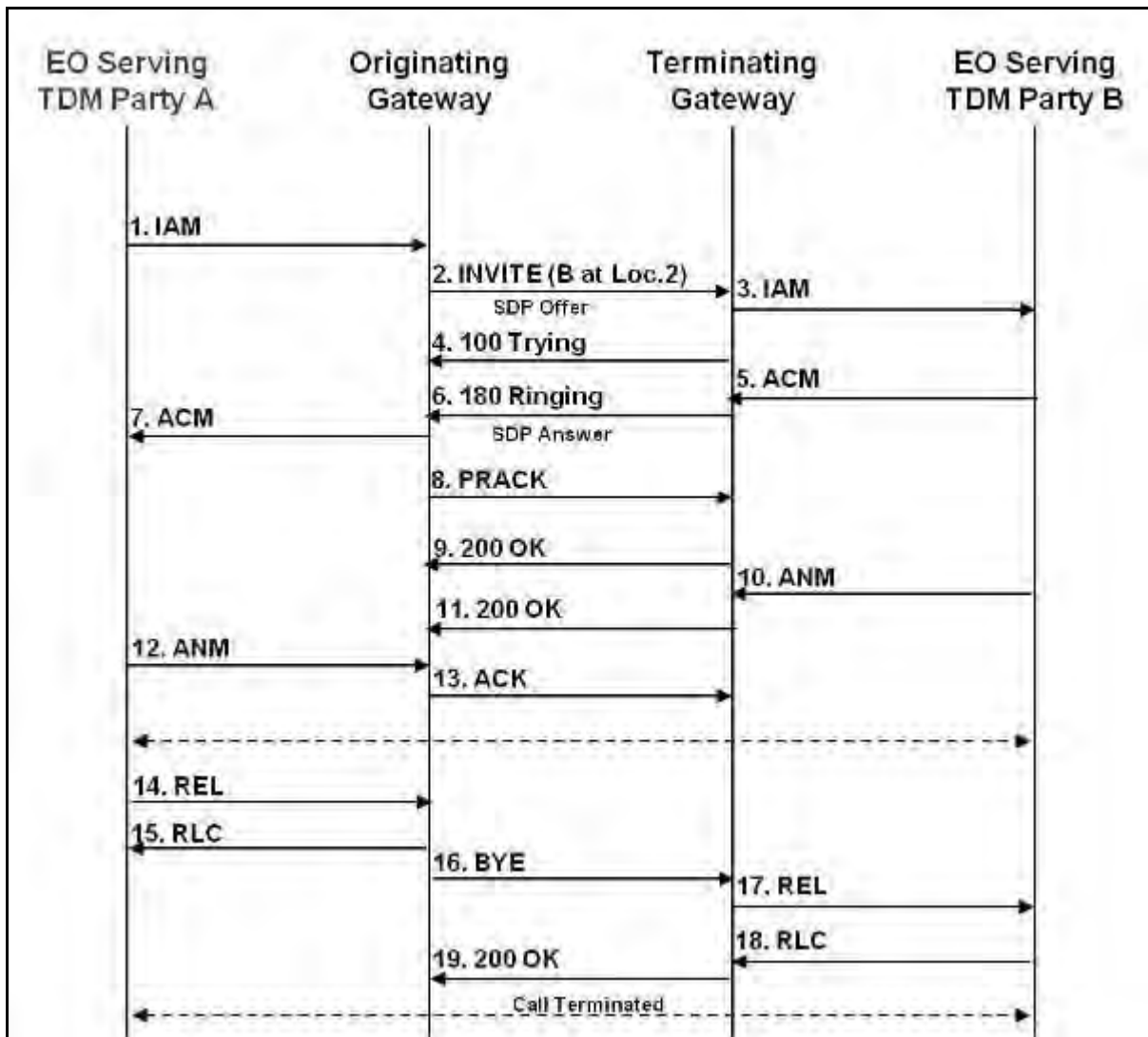

Figure 16.2-1. Successful Basic TDM Bridging Call (No Preconditions)

Call Establishment

STEP	INSTRUCTION
1	The EO serving TDM Party A detects an off-hook and receives the dialed string. The EO sends an IAM through the SS7 network to the originating gateway.
2	The originating gateway receives the IAM, creates an INVITE, and sends the INVITE to the terminating gateway.
3	The terminating gateway receives the INVITE, creates an IAM, and sends the IAM to the EO serving TDM Party B.
4	The terminating gateway sends a 100 (Trying) response code to the originating gateway.
5	The EO serving TDM Party B initiates ringing of the EI and sends an ACM to the terminating gateway.
6	The terminating gateway creates a 180 (Ringing) response code and sends the 180 (Ringing) response to the originating gateway.
7	The originating gateway receives the 180 (Ringing), creates an ACM, and sends the ACM to the EO serving TDM Party A.
8	The originating gateway sends a PRACK to the terminating gateway.
9	The terminating gateway sends a 200 (OK) PRACK to the originating gateway.
10	When TDM Party B goes off hook (i.e., answers the call), the EO serving TDM Party B sends an ANM to the terminating gateway.
11	The terminating gateway creates a 200 (OK) response and sends the 200 (OK) response to the originating gateway.
12	The originating gateway receives the 200 (OK) response, creates an ANM, and sends the ANM to the EO serving TDM Party A.
13	The originating gateway sends an ACK to the terminating gateway.

Call Release

STEP	INSTRUCTION
14	The EO serving TDM Party A detects an on-hook and sends an REL to the originating gateway.
15	The originating gateway sends an RLC (Release Complete message) to the EO serving TDM Party A.
16	The originating gateway sends a BYE over the IP network to the terminating gateway.
17	The terminating gateway receives the BYE and sends REL to the EO serving TDM Party A.
18	The EO serving TDM Party A sends an RLC to the terminating gateway.
19	The terminating gateway sends a 200 (OK) response to the originating gateway.

16.2.2.2 TDM Bridging Call Type (Segmented Precondition)

SIP-010300 [Figure 16.2-2](#), Successful Basic TDM Bridging Call (Segmented Precondition), depicts the sequence of AS-SIP and ISUP messages between the end office serving TDM Party A and the end office serving TDM Party B used to establish a telephony session across the IP WAN, using a segmented precondition.

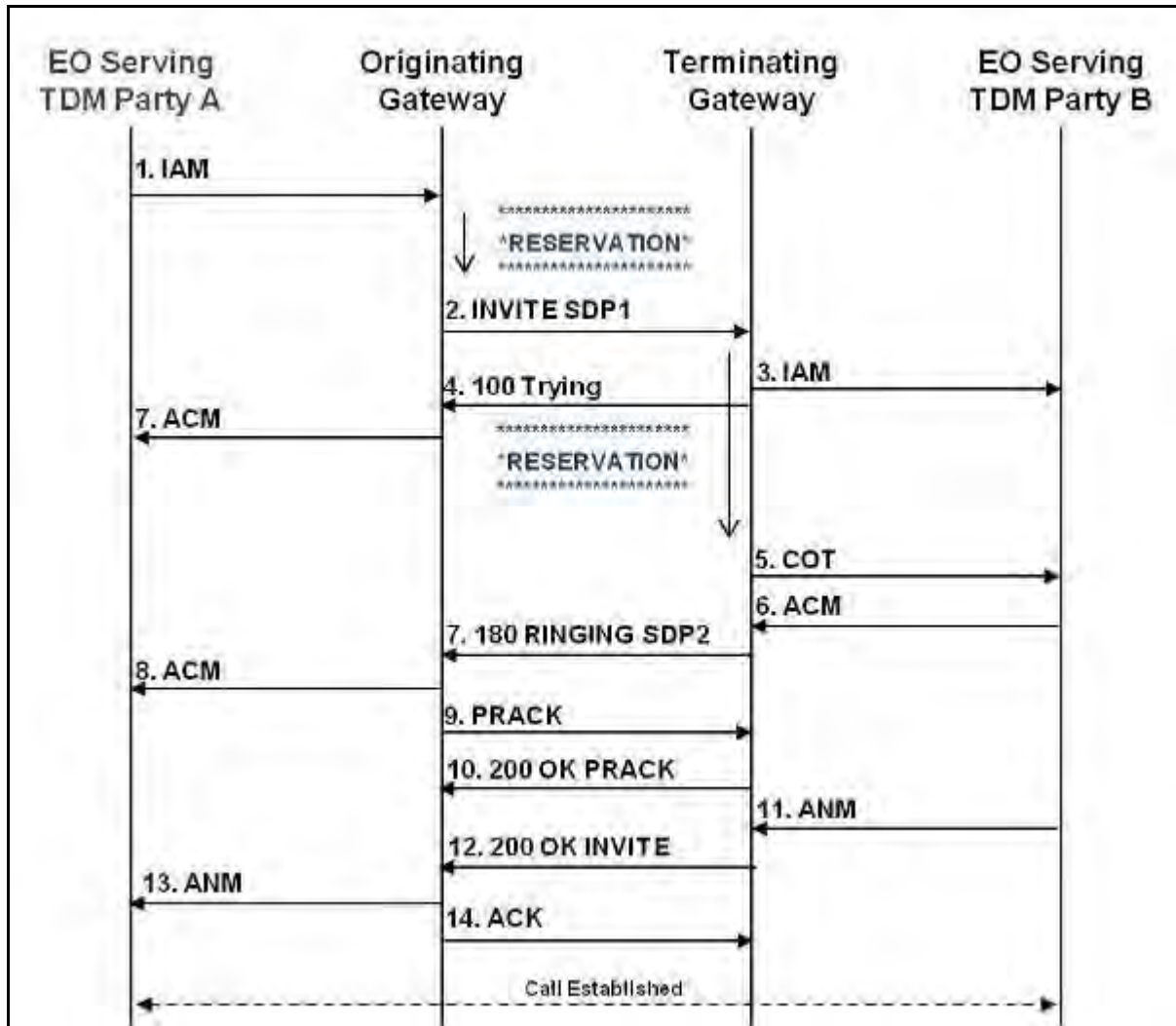

Figure 16.2-2. Successful Basic TDM Bridging Call (Segmented Precondition)

Call Establishment

STEP	INSTRUCTION
1	The EO serving TDM Party A detects an off-hook and receives the dialed string. The EO sends an IAM through the SS7 network to the originating gateway.
2	Upon receiving the IAM from the EO serving TDM Party A, the originating gateway satisfies its local precondition before sending an INVITE request to the terminating gateway. The INVITE request contains a segmented precondition offer using SDP attributes described in RFC 3312. The precondition offer includes, at a minimum, a media (“m=”) line, a connection (“c=”) line, at least two current-status lines (local and remote), and at least two desired-status lines (local and remote). The originating gateway forwards the INVITE request to the terminating gateway.
3	The terminating gateway receives the INVITE request, creates an IAM, sets the Continuity Check Indicator of the Nature of Connection Indicators to “Continuity check performed on a previous circuit,” or “Continuity check required on this circuit,” and sends the IAM to the EO serving TDM Party B. In addition, the terminating gateway goes about satisfying its local preconditions.

STEP	INSTRUCTION
	NOTE: If the terminating gateway does not make use of the COT message, then the terminating gateway can refrain from initiating any SS7 messaging until after the resources have been reserved.
4	The terminating gateway sends a 100 (Trying) response to the originating gateway.
5	After all SIP preconditions have been met, the terminating gateway sends a COT message to the EO serving TDM Party B so that the EO can send a ring tone to TDM Party B.
	NOTE: If the terminating gateway did not send an IAM in Step 3, then the terminating gateway sends an IAM with the Continuity Check Indicator of the Nature of Connection Indicators set to "00" "continuity check not required."
6	The EO serving TDM Party B sends an ACM to the terminating gateway.
7	When the terminating gateway receives an ACM from the EO serving TDM Party B, it creates a 180 (Ringing) response with an answer to the segmented precondition offer that includes, at a minimum, a media ("m=") line, a connection ("c=") line, at least two current-status lines, and at least two desired-status lines. The terminating gateway sends the 180 (Ringing) response to the originating gateway.
8	The originating gateway receives the 180 (Ringing) response and sends the ACM to the EO serving TDM Party A.
9	The originating gateway sends a PRACK request to the terminating gateway.
10	The terminating gateway sends a 200 (OK) PRACK request to the originating gateway.
11	When TDM Party B goes off hook (i.e., answers the call), the EO serving TDM Party B sends an ANM to the terminating gateway.
12	The terminating gateway receives the ANM, creates a 200 (OK) INVITE request, and sends the 200 (OK) INVITE request to the originating gateway.
13	The originating gateway receives the 200 (OK) response, creates an ANM, and sends the ANM to the EO serving TDM Party A.
14	The originating gateway sends an ACK to the terminating gateway.

The call is established now.

16.2.2.3 TDM Bridging Call Type (End-to-End Precondition)

SIP-010310 [Figure 16.2-3](#), Successful Basic TDM Bridging Call (End-to-End Precondition), depicts the sequence of AS-SIP and ISUP messages between the end office serving TDM Party A and the end office serving TDM Party B used to establish a telephony session across the IP WAN, using a status-type end-to-end precondition.

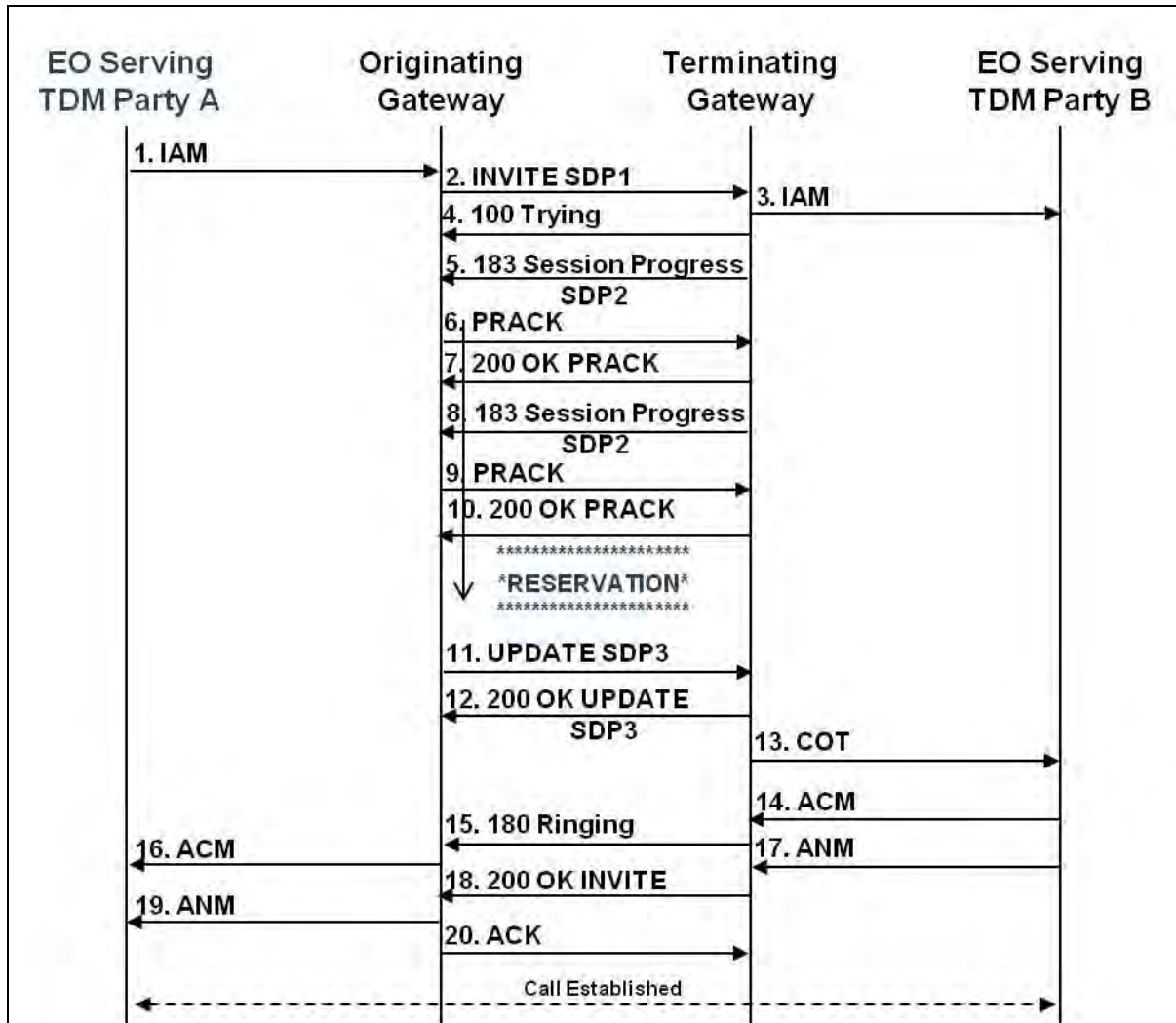

Figure 16.2-3. Successful Basic TDM Bridging Call (End-to-End Precondition)

Call Establishment

STEP	INSTRUCTION
1	The EO serving TDM Party A detects an off-hook and receives the dialed string. The EO sends an IAM through the SS7 network to the originating gateway.
2	The originating gateway creates an INVITE request containing an E2E precondition offer using SDP attributes described in RFC 3312. The precondition offer includes, at a minimum, a media (“m=”) line, a connection (“c=”) line, at least one current-status line, and at least one desired-status line. The originating gateway forwards the INVITE request to the terminating gateway.
3	The terminating gateway receives the INVITE request, creates an IAM, sets the Continuity Check Indicator of the Nature of Connection Indicators to “Continuity check performed on a previous circuit,” or “Continuity check required on this circuit,” and sends the IAM to the EO serving TDM Party B.
	NOTE: If the terminating gateway does not make use of the COT message, then the terminating gateway can refrain from initiating any SS7 messaging until after it receives confirmation that the resources have been reserved and sends its acknowledgement in Step 9.

STEP	INSTRUCTION
4	The terminating gateway sends a 100 (Trying) response to the originating gateway.
5	The terminating gateway sends a 183 (Session Progress) response to the originating gateway with an answer to the E2E precondition offer that includes, at a minimum, a media (“m=”) line, a connection (“c=”) line, at least one current-status line, at least one desired-status line, and at least one confirm-status line. The terminating gateway sends the 183 (Session Progress) response to the originating gateway. The terminating gateway and the originating gateway attempt to reserve the resources needed to fulfill the preconditions.
6	The originating gateway sends a PRACK request to the terminating gateway.
7	The terminating gateway sends a 200 (OK) PRACK request to the originating gateway.
8	The terminating gateway sends a 183 (Session Progress) response with sdp (wherein the contents of the sdp body is an exact duplicate of the contents of sdp2 sent in Step 5) to the originating gateway immediately after sending the 200 (OK) PRACK request to notify the originating gateway that early media will be sent over the backward bearer path.
9	The originating gateway sends a PRACK request to the terminating gateway.
10	The terminating gateway sends a 200 (OK) PRACK request to the originating gateway.
11	When the originating gateway receives a confirmation that it has met its precondition (e.g., receives an RSVP RESV message), then it sends an UPDATE request to the terminating gateway with an updated offer reflecting compliance with its part of the precondition. The updated precondition offer includes, at a minimum, a media (“m=”) line, a connection (“c=”) line, at least one current-status line, and at least one desired-status line.
12	The terminating gateway receives a confirmation that it has met its precondition (e.g., receives an RSVP RESV message) and sends a 200 (OK) UPDATE request to the originating gateway with an updated precondition answer reflecting compliance with its part of the precondition as well as the most recent updated information from the UPDATE offer. The updated answer includes, at a minimum, a media (“m=”) line, a connection (“c=”) line, at least one current-status line, at least one desired-status line.
13	Now that all SIP preconditions have been met, the terminating gateway sends a COT message to the EO serving TDM Party B so that the EO can send a ring tone to TDM Party B.
	NOTE: If the terminating gateway did not send an IAM in Step 3, then the terminating gateway sends an IAM with the Continuity Check Indicator of the Nature of Connection Indicators set to “00” “continuity check not required.”
14	The EO serving TDM Party B sends an ACM to the terminating gateway.
15	The terminating gateway receives the ACM, creates a 180 (Ringing) response, and sends the 180 (Ringing) response to the originating gateway.
16	The originating gateway receives the 180 (Ringing) response, creates an ACM, and sends the ACM to the EO serving TDM Party A.
17	When TDM Party B goes off hook (i.e., answers the call), the EO serving TDM Party B sends an ANM to the terminating gateway.
18	The terminating gateway receives the ANM, creates a 200 (OK) INVITE request, and sends the 200 (OK) INVITE request to the originating gateway.
19	The originating gateway receives the 200 (OK) response, creates an ANM, and sends the ANM to the EO serving TDM Party A.
20	The originating gateway sends an ACK to the terminating gateway.

The call is established now.

16.2.3 TDM-to-IP Call Type

16.2.3.1 TDM-to-IP Call Type (No Preconditions)

SIP-010320 [Figure 16.2-4](#), Successful Basic TDM-to-IP Call (No Preconditions), depicts the sequence of AS-SIP and ISUP messages between the EO serving TDM Party A and the SC serving IP Party B used to establish, and then tear down a telephony session. The call flow diagram does not depict the use of preconditions.

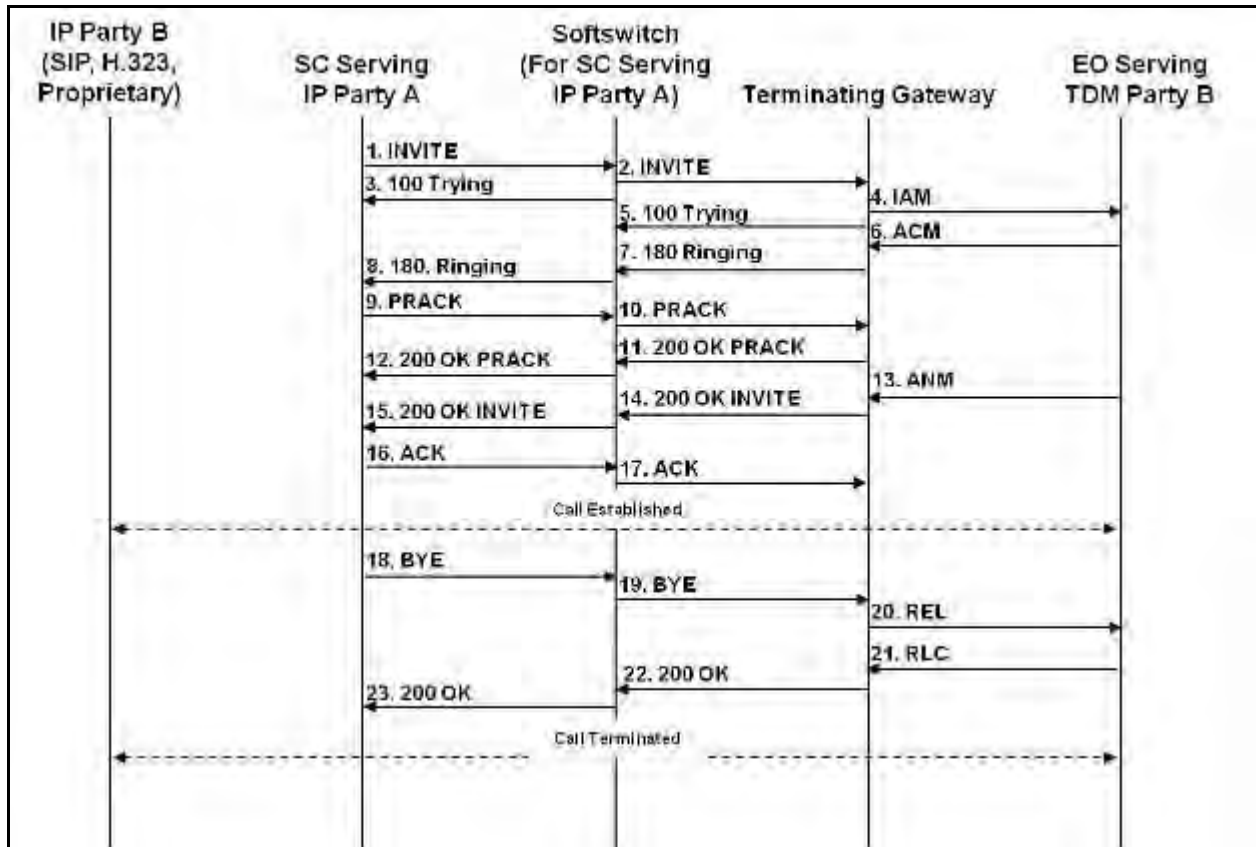

Figure 16.2-4. Successful Basic TDM-to-IP Call (No Preconditions)

Call Establishment

STEP	INSTRUCTION
1	The EO serving TDM Party A detects an off-hook and receives the dialed string. The EO sends an IAM through the SS7 network to the originating gateway.
2	The originating gateway receives the IAM, creates an INVITE request, and sends the INVITE request to the SS assigned to the SC serving IP Party B.
3	The SS receives the INVITE request and forwards the INVITE request to the SC serving IP Party B.
	NOTE: Signaling is not depicted between the SC serving IP Party B and the EI serving IP Party B.
4	The SS sends a 100 (Trying) response to the originating gateway.

STEP	INSTRUCTION
5	The SC serving IP Party B sends a 100 (Trying) response to the SS.
6, 7	Assuming the EI is not busy, the SC serving IP Party B sends a 180 (Ringing) response to the SS, and the SS forwards the 180 (Ringing) response to the originating gateway.
	NOTE: Signaling is not depicted between the EI serving IP Party B and the SC serving IP Party B.
8	The originating gateway creates an ACM and sends it to the EO serving TDM Party A.
9, 10	When IP Party B goes off-hook (i.e., answers the call), the SC serving IP Party B sends a 200 (OK) response to the SS. It forwards the 200 (OK) response to the originating gateway.
	NOTE: Signaling is not depicted between the EI serving IP Party B and the SC serving IP Party B.
11	The originating gateway creates an ANM and sends it to the EO serving TDM Party A.
12, 13	The originating gateway sends an ACK to the SS. The SS forwards the ACK to the SC serving IP Party B.
	NOTE: Signaling is not depicted between the SC serving IP Party B and the EI serving IP Party B.

Call Release

STEP	INSTRUCTION
14	The EO serving TDM Party A detects an on-hook and sends a REL to the originating gateway.
15	The originating gateway sends an RLC to the EO serving TDM Party A.
16	The originating gateway sends a BYE request over the IP network to the SS.
17	The SS forwards the BYE request to the SC serving IP Party B.
	NOTE: Signaling between the SC serving IP Party B and the EI serving IP Party B is not depicted.
18, 19	The SC serving IP Party B sends a 200 (OK) response to the SS, and the SS forwards the 200 (OK) response to the originating gateway.
	NOTE: Signaling between the EI serving IP Party B and the SC serving IP Party B is not depicted.

16.2.3.2 TDM-to-IP Call Type (Segmented Precondition)

SIP-010330 [Figure 16.2-5](#) depicts the sequence of AS-SIP and ISUP messages between the EO serving TDM Party A and the SC serving IP Party B used to establish a telephony session, using a segmented precondition.

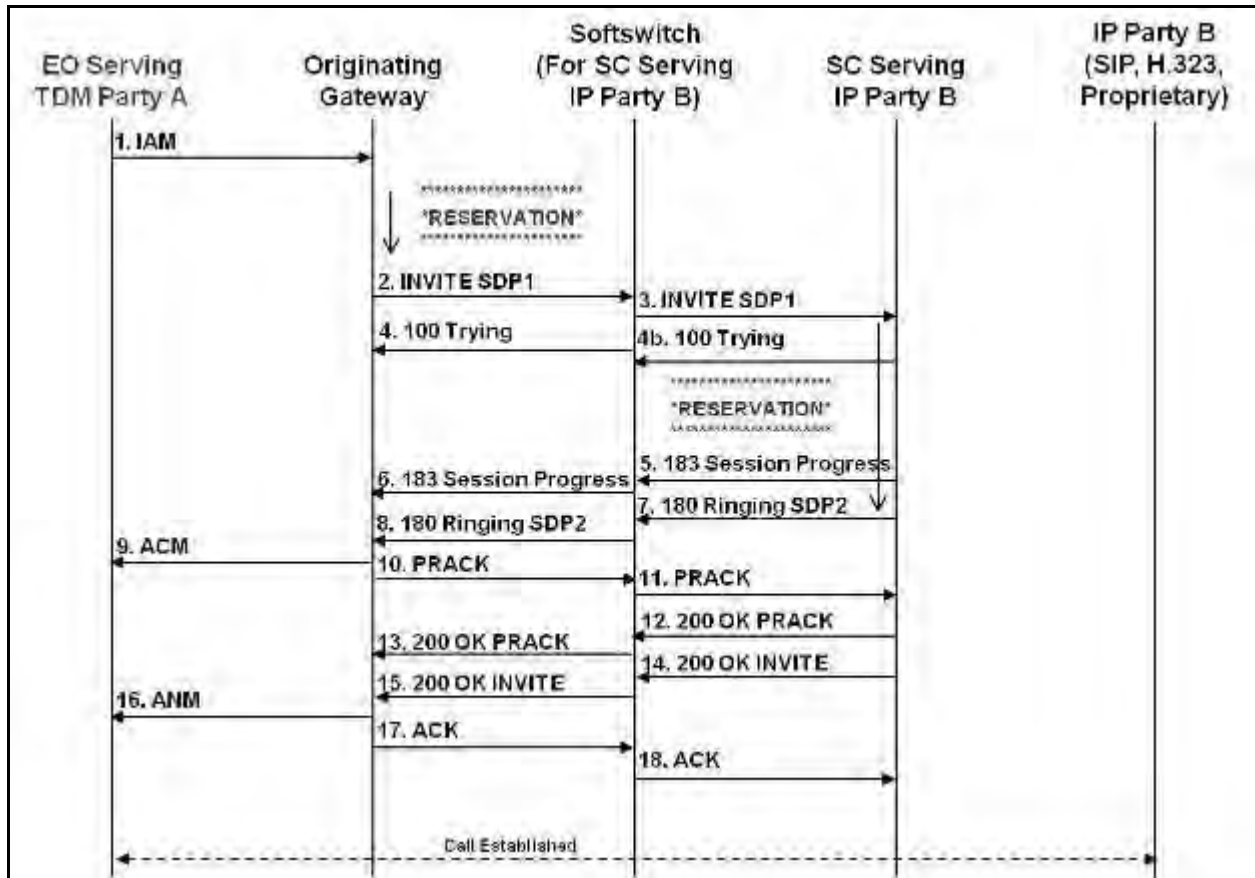

Figure 16.2-5. Successful Basic TDM-to-IP Call (Segmented Precondition)

Call Establishment

STEP	INSTRUCTION
1	The EO serving TDM Party A detects an off-hook and receives the dialed string. The EO sends an IAM through the SS7 network to the originating gateway.
2	Upon receiving the IAM from the EO serving TDM Party A, the originating gateway satisfies its local precondition before sending an INVITE to the SS for the SC serving IP Party B. The INVITE contains a segmented precondition offer using SDP attributes described in RFC 3312. The precondition offer includes, at a minimum, a media (“m=”) line, a connection (“c=”) line, at least two current-status lines (local and remote), and at least two desired-status lines (local and remote).
3	The SS forwards the INVITE to the SC serving IP Party B.
4	The SS sends a 100 (Trying) response code to the originating gateway.
4b	The SC serving IP Party B sends a 100 (Trying) response code to the SS.
5, 6	The SC serving IP Party B sends a 183 (Session Progress) response code with no sdp before sending the 180 (Ringing) response code with an answer to the segmented precondition offer to notify the originating gateway that there is no early media, and ringback must be generated locally.

STEP	INSTRUCTION
7, 8	The SC serving IP Party B satisfies its local precondition, notifies the IP EI of the pending call and sends a 180 (Ringing) response with an answer to the segmented precondition offer that includes, at a minimum, a media (“m=”) line, a connection (“c=”) line, at least two current-status lines, and at least two desired-status lines to the SS. The SS forwards the 180 (Ringing) response to the originating gateway.
	NOTE: Signaling is not depicted between the SC serving IP Party B and the EI serving IP Party B.
9	The originating gateway receives the 180 (Ringing) response and sends an ACM to the EO serving TDM Party A.
10, 11	The originating gateway sends a PRACK to the SS, and the SS forwards the PRACK to the SC serving IP Party B.
12, 13	The SC serving IP Party B sends a 200 (OK) PRACK to the SS, and the SS forwards the 200 (OK) PRACK to the originating gateway.
14, 15	The SC serving IP Party B sends a 200 (OK) INVITE to the SS. The SS forwards the 200 (OK) INVITE to the originating gateway.
	NOTE: Signaling is not depicted between the IP EI serving IP Party B and the SC serving IP Party B.
16	The originating gateway receives the 200 (OK) INVITE and sends an ANM to the EO serving TDM Party A.
17, 18	The originating gateway sends the ACK to the SS, which forwards the ACK to the SC serving IP Party B.
	NOTE: Signaling is not depicted between the SC serving IP Party B and the IP EI serving IP Party B.

The call is established now.

16.2.3.3 TDM-to-IP Call Type (End-to-End Precondition)

SIP-010340 [Figure 16.2-6](#) depicts the sequence of AS-SIP and ISUP messages between the EO serving TDM Party A and the SC serving IP Party B used to establish a telephony session using a status-type end-to-end precondition.

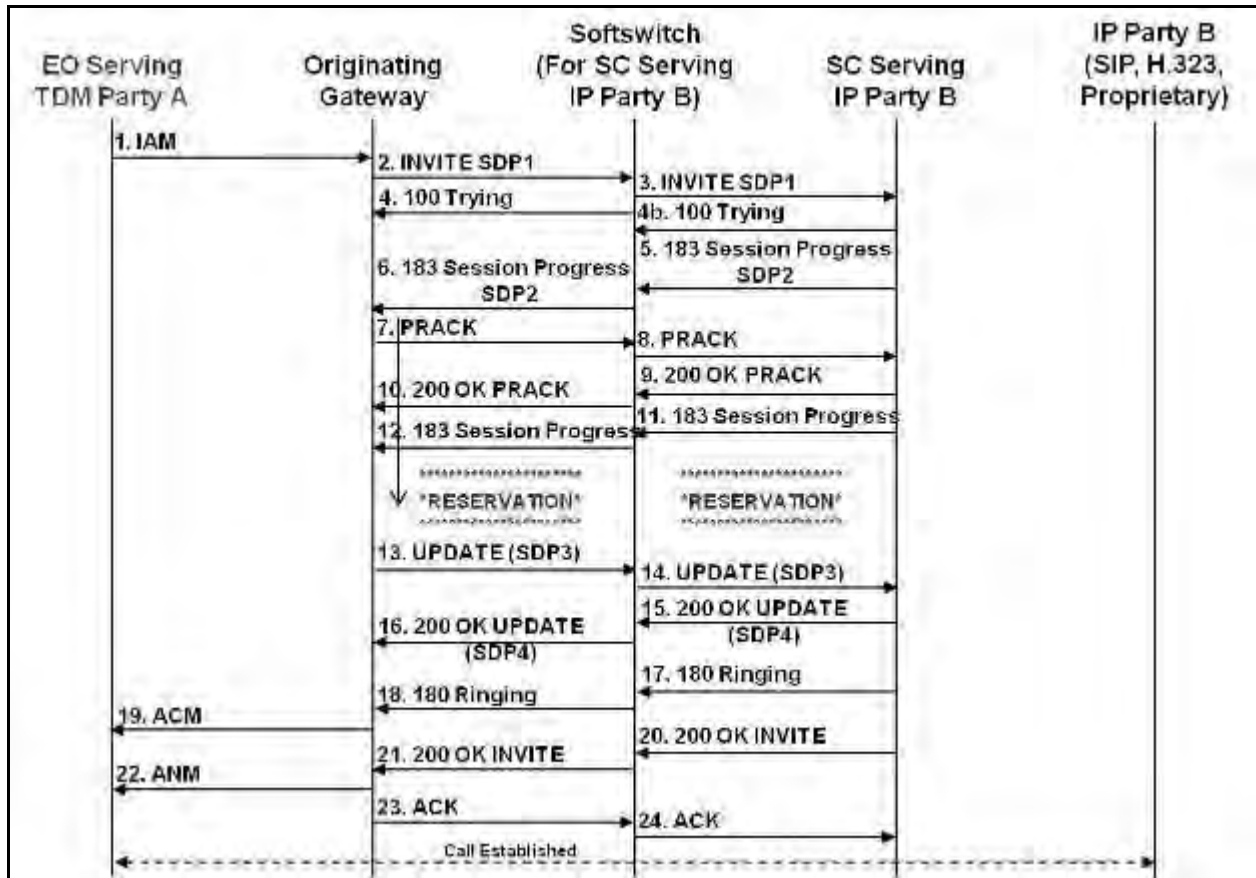

Figure 16.2-6. Successful Basic TDM-to-IP Call (End-to-End Precondition)

Call Establishment

STEP	INSTRUCTION
1	The EO serving TDM Party A detects an off-hook and receives the dialed string. The EO sends an IAM through the SS7 network to the originating gateway.
2	Upon receiving the IAM from the EO serving TDM Party A, the originating gateway sends an INVITE to the SS for the SC serving IP Party B. The INVITE contains an end-to-end precondition offer using SDP attributes described in RFC 3312. The precondition offer includes, at a minimum, a media (“m=”) line, a connection (“c=”) line, at least 1 current-status line, and at least 1 desired-status line.
3	The SS receives and forwards the INVITE to the SC serving IP Party B.
4	The SS sends a 100 (Trying) response code to the originating gateway.
4b	The SC serving IP Party B sends a 100 (Trying) response code to the SS.
5, 6	The SC serving IP Party B sends a 183 (Session Progress) response code to the SS with an answer to the E2E precondition offer that includes, at a minimum, a media (“m=”) line, a connection (“c=”) line, at least one current-status line, at least one desired-status line, and at least one confirm-status line. The SS forwards the 183 (Session Progress) response to the originating gateway. The SC serving IP Party B and the originating gateway attempt to reserve the resources needed to fulfill the preconditions.
7, 8	The originating gateway sends a PRACK to the SS, and the SS forwards the PRACK to the SC serving IP Party B.

STEP	INSTRUCTION
9, 10	The SC serving IP Party B sends a 200 (OK) PRACK to the SS, and the SS forwards the 200 (OK) PRACK to the originating gateway.
11, 12	The SC serving IP Party B sends a 183 (Session Progress) response code with no sdp immediately after sending the 200 (OK) PRACK to notify the originating gateway that it will not be receiving early media over the backward bearer path.
13, 14	When the originating gateway receives a confirmation that it has met its precondition (e.g., receives an RSVP RESV message), then it sends an UPDATE to the SS with an updated offer reflecting compliance with its part of the precondition. The updated precondition offer includes, at a minimum, a media (“m=”) line, a connection (“c=”) line, at least one current-status line, and at least one desired-status line. The SS forwards the UPDATE to the SC serving IP Party B.
15, 16	The SC serving IP Party B receives a confirmation that it has met its precondition (e.g., receives an RSVP RESV message) and sends a 200 (OK) UPDATE to the SS with an updated precondition answer reflecting compliance with its part of the precondition as well as the most recent updated information from the UPDATE offer. The updated answer includes, at a minimum, a media (“m=”) line, a connection (“c=”) line, at least one current-status line, and at least one desired-status line. The SS forwards the 200 (OK) UPDATE to the originating gateway.
17, 18	The preconditions have been met so the SC serving IP Party B notifies the IP EI of the pending call and sends a 180 (Ringing) response code to the SS. The SS forwards the 180 (Ringing) response to the originating gateway.
	NOTE: Signaling is not depicted between the SC serving IP Party B and the EI serving IP Party B.
19	The originating gateway receives the 180 (Ringing) response and sends an ACM to the EO serving TDM Party A.
20, 21	The SC serving IP Party B sends a 200 (OK) INVITE to the SS. The SS forwards the 200 (OK) INVITE to the originating gateway.
	NOTE: Signaling is not depicted between the IP EI serving IP Party B and the SC serving IP Party B.
22	The originating gateway receives the 200 (OK) INVITE and sends an ANM to the EO serving TDM Party A.
23, 24	The originating gateway sends an ACK to the SS and the SS forwards the ACK to the SC serving IP Party B.
	NOTE: Signaling is not depicted between the SC serving IP Party B and the EI serving IP Party B.

The call is now established.

16.2.4 IP-to-TDM Call Type

16.2.4.1 IP-to-TDM Call Type (No Preconditions)

SIP-010350 [Figure 16.2-7](#), Successful Basic IP-to-TDM Call (No Preconditions), depicts the sequence of AS-SIP and ISUP messages between the SC serving IP Party A and the EO serving TDM Party B used to establish, and then tear down a telephony session. The call flow diagram does not depict the use of preconditions.

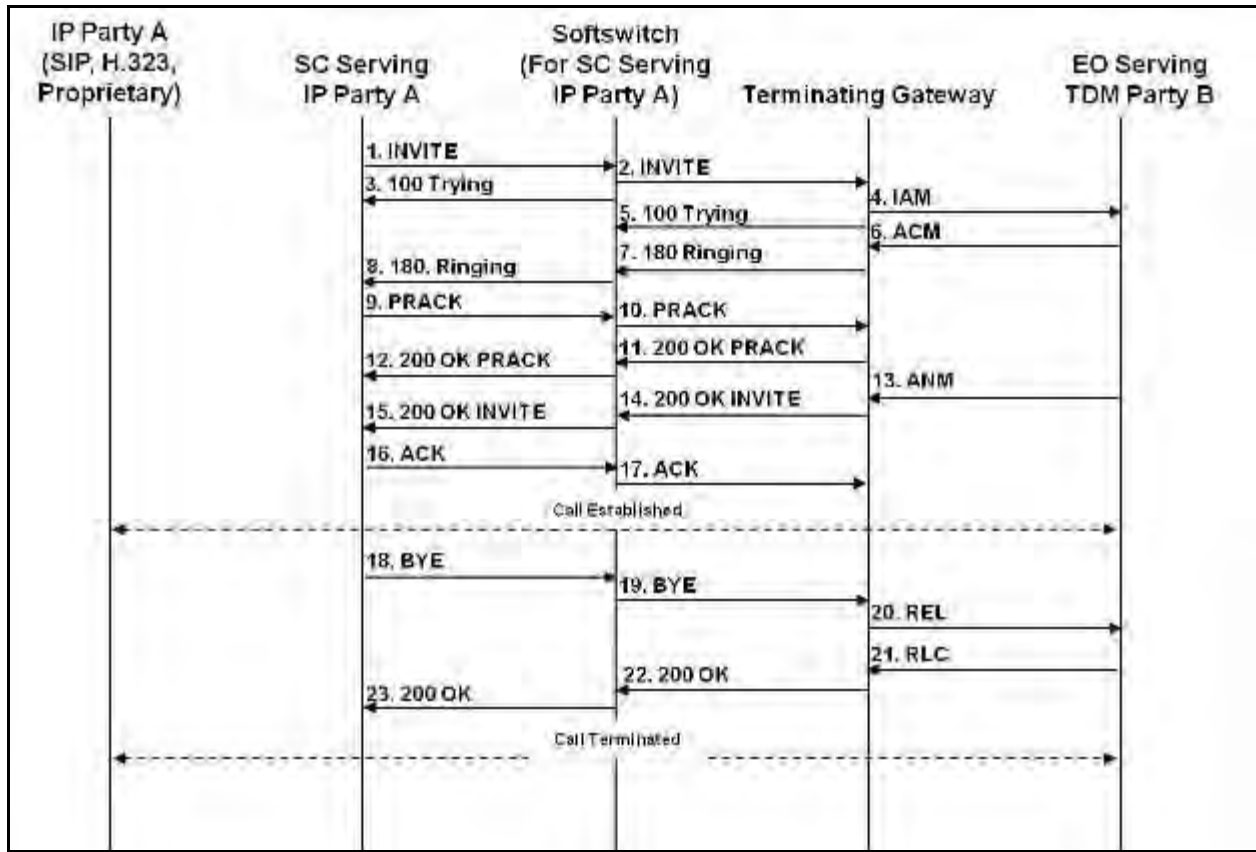

Figure 16.2-7. Successful Basic IP-to-TDM Call (No Preconditions)

Call Establishment

STEP	INSTRUCTION
1, 2	Upon receiving an initial call request message from IP Party A (not depicted in the call flow diagram), the SC serving IP Party A sends an INVITE to its assigned SS. The SS forwards the INVITE to the terminating gateway. NOTE: Signaling is not depicted between the EI serving Party A and the SC serving IP Party A.
3	The SS sends a 100 (Trying) response code to the SC serving IP Party A.
4	The terminating gateway creates an IAM and sends the IAM to the EO serving TDM Party B.
5	The terminating gateway sends a 100 (Trying) response code to the SS.
6	The EO serving TDM Party B initiates ringing of the EI and sends an ACM to the terminating gateway.
7, 8	The terminating gateway creates a 180 (Ringing) response and sends the 180 (Ringing) to the SS. The SS forwards the 180 (Ringing) to the SC serving IP Party A. NOTE: Signaling is not depicted between the SC serving IP Party A and the EI serving IP Party A.
9, 10	The SC serving IP Party A sends a PRACK to the SS and it sends the PRACK to the terminating gateway. NOTE: Signaling is not depicted between the EI serving IP Party A and the SC serving IP Party A.

STEP	INSTRUCTION
11, 12	The terminating gateway sends a 200 (OK) PRACK to the SS. The SS sends the 200 (OK) PRACK to the SC serving IP Party A.
13	When TDM Party B goes off-hook (i.e., answers the call), the EO serving TDM Party B sends an ANM to the terminating gateway.
14, 15	The terminating gateway creates a 200 (OK) response and sends the 200 (OK) response to the SS. The SS forwards the 200 (OK) response to the SC serving IP Party A.
	NOTE: Signaling is not depicted between the SC serving IP Party A and the EI serving IP Party A.
16, 17	The SC serving IP Party A sends an ACK to the SS. The SS forwards the ACK to the terminating gateway.
	NOTE: Signaling is not depicted between the EI serving IP Party A and the SC serving IP Party A.

Call Release

STEP	INSTRUCTION
18, 19	The SC serving IP Party A sends a BYE request to the SS, which in turn sends the BYE request to the terminating gateway.
	NOTE: Signaling is not depicted between the EI serving IP Party A and the SC serving IP Party A that initiated the call release.
20	The terminating gateway sends an REL to the EO serving TDM Party B.
21	The EO serving TDM Party B sends an RLC to the terminating gateway.
22, 23	The terminating gateway sends a 200 (OK) response to the SS and the SS forwards the 200 (OK) response to the SC serving IP Party A.
	NOTE: Signaling is not depicted between the SC serving IP Party A and the EI serving IP Party A.

16.2.4.2 IP-to-TDM Call Type (Segmented Precondition)

SIP-010360 [Figure 16.2-8](#) depicts the sequence of AS-SIP and ISUP messages between the SC serving IP Party A and the EO serving TDM Party B used to establish a telephony session using a segmented precondition.

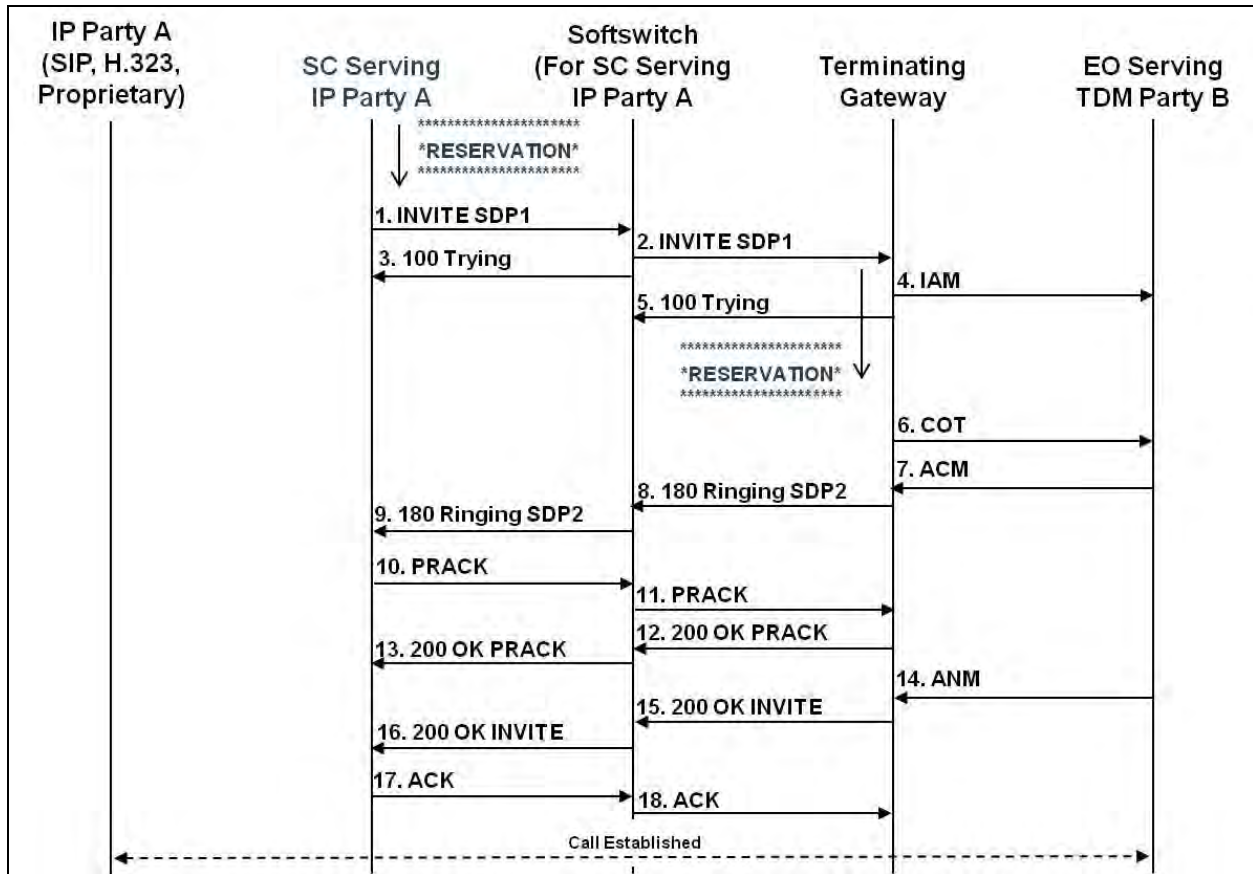

Figure 16.2-8. Successful Basic IP-to-TDM Call (Segmented Precondition)

Call Establishment

STEP	INSTRUCTION
1, 2	Upon receiving an initial call request message from IP Party A (not depicted in the call flow diagram), the SC serving IP Party A satisfies its local precondition before sending an INVITE to its assigned SS. The INVITE contains a segmented precondition offer using SDP attributes described in RFC 3312. The precondition offer includes, at a minimum, a media (“m=”) line, a connection (“c=”) line, at least two current-status lines (local and remote), and at least two desired-status lines (local and remote). The SS forwards the INVITE to the terminating gateway.
3	The SS sends a 100 (Trying) response code to the SC serving IP Party A.
4	The terminating gateway receives the INVITE, creates an IAM, sets the Continuity Check indicator of the Nature of Connection Indicators to “Continuity check performed on a previous circuit” or “Continuity check required on this circuit,” and sends the IAM to the EO serving TDM Party B. The terminating gateway also goes about satisfying its local preconditions.
	NOTE: If the terminating gateway does not make use of the COT message, then the terminating gateway can refrain from initiating any SS7 messaging until after the resources have been reserved.
5	The terminating gateway sends a 100 (Trying) response code to the SS.
6	Once the SIP preconditions have all been met, the terminating gateway sends a COT message to the EO serving TDM Party B so that the EO can send a ring tone to TDM Party B.

STEP	INSTRUCTION
	NOTE: If the terminating gateway did not send an IAM in Step 3, then the terminating gateway sends an IAM with the Continuity Check indicator of the Nature of Connection Indicators set to "00" "Continuity check not required."
7	The EO sends an ACM to the terminating gateway.
8, 9	When the terminating gateway receives an ACM from the EO serving TDM Party B, it creates a 180 (Ringing) response with an answer to the segmented precondition offer that includes, at a minimum, a media ("m=") line, a connection ("c=") line, at least two current-status lines, and at least two desired-status lines. The terminating gateway sends the 180 (Ringing) response to the SS, which forwards the 180 (Ringing) to the SC serving IP Party A.
10, 11	The SC serving IP Party A sends a PRACK to the SS, which forwards the PRACK to the terminating gateway.
	NOTE: Signaling is not depicted between the SC serving IP Party A and the EI serving IP Party A.
12, 13	The terminating gateway sends a 200 (OK) PRACK to the SS, which forwards the 200 (OK) PRACK to the SC serving IP Party A.
14	When TDM Party B goes off-hook (i.e., answers the call), the EO serving TDM Party B sends an ANM to the terminating gateway.
15, 16	The terminating gateway creates a 200 (OK) INVITE and sends the 200 (OK) INVITE to the SS, which forwards the 200 (OK) INVITE to the SC serving IP Party A.
	NOTE: Signaling is not depicted between the EI serving IP Party A and the SC serving IP Party A.
17, 18	The SC serving IP Party A sends an ACK to the SS, which forwards the ACK to the terminating gateway.

The call is now established.

16.2.4.3 IP-to-TDM Call Type (End-to-End Precondition)

SIP-010370 [Figure 16.2-9](#) depicts the sequence of AS-SIP and ISUP messages between the SC serving IP Party A and the EO serving TDM Party B to establish a telephony session using a status-type end-to-end precondition.

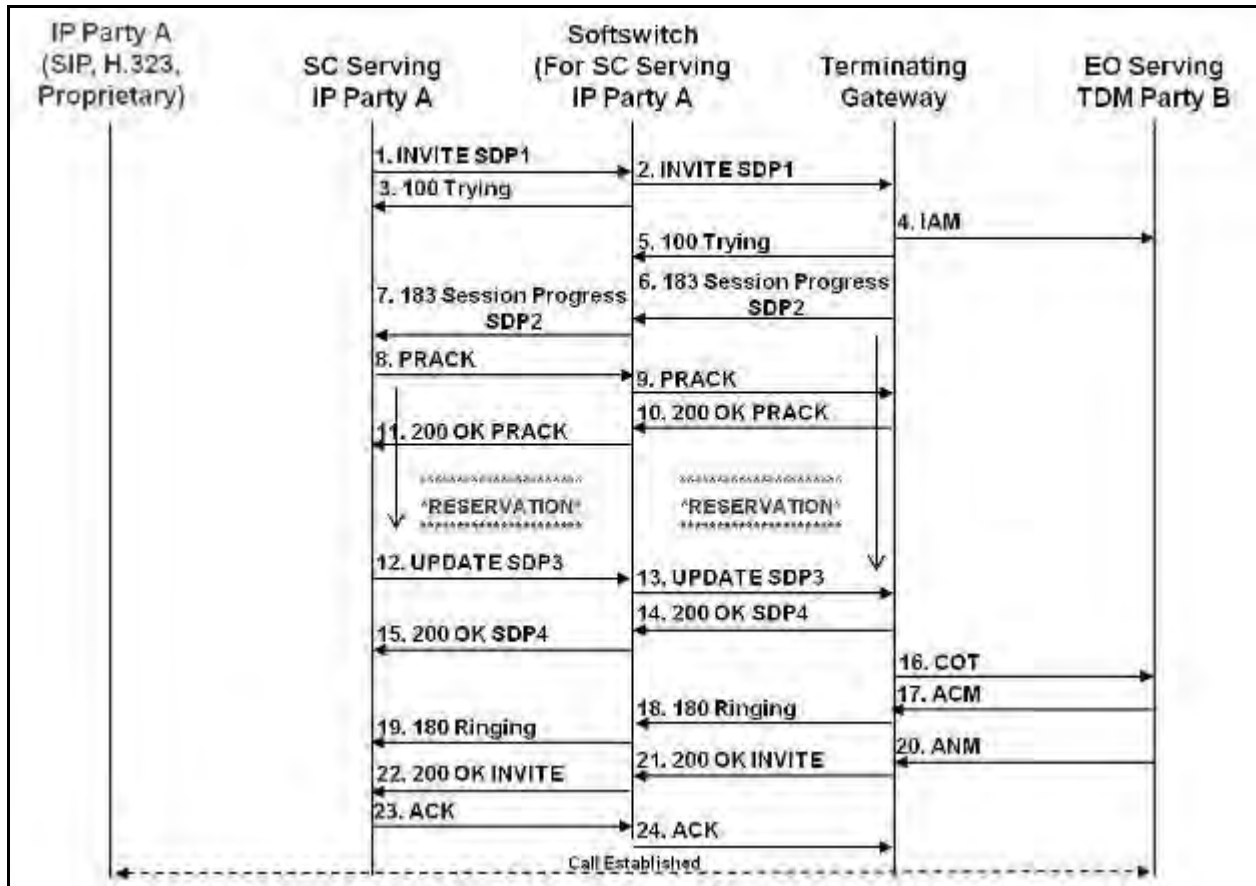

Figure 16.2-9. Successful Basic IP-to-TDM Call (End-to-End Precondition)

Call Establishment

STEP	INSTRUCTION
1, 2	Upon receiving an initial call request message from IP Party A (not depicted in the call flow diagram), the SC serving IP Party A sends an INVITE to its assigned SS. The INVITE contains an E2E precondition offer using SDP attributes described in RFC 3312. The precondition offer includes, at a minimum, a media (“m=”) line, a connection (“c=”) line, at least one current-status line, and at least one desired-status line. The SS forwards the INVITE to the terminating gateway.
3	The SS sends a 100 (Trying) response code to the SC serving IP Party A.
4	The terminating gateway receives the INVITE, creates an IAM, sets the Continuity Check indicator of the Nature of Connection Indicators to “Continuity check performed on a previous circuit” or “Continuity check required on this circuit,” and sends the IAM to the EO serving TDM Party B.
	NOTE: If the terminating gateway does not make use of the COT message, then the terminating gateway can refrain from initiating any SS7 messaging until after it receives confirmation that the resources have been reserved and sends its acknowledgement in Step 14.
5	The terminating gateway sends a 100 (Trying) response code to the SS.

STEP	INSTRUCTION
6, 7	The terminating gateway sends a 183 (Session Progress) response code to the SS with an answer to the E2E precondition offer that includes, at a minimum, a media (“m=”) line, a connection (“c=”) line, at least one current-status line, at least one desired-status line, and at least one confirm-status line. The SS sends the 183 (Session Progress) response to the SC serving IP Party A. The terminating gateway and the SC serving IP Party A attempt to reserve the resources needed to fulfill the preconditions.
8, 9	The SC serving IP Party A sends a PRACK to the SS, which forwards the PRACK to the terminating gateway.
10, 11	The terminating gateway sends a 200 (OK) PRACK to the SS, which forwards the 200 (OK) PRACK to the SC serving IP Party A.
12, 13	When the SC serving IP Party A receives confirmation that it has met its precondition (e.g., receives an RSVP RESV message), then the SC serving IP Party A sends an UPDATE to the SS with an updated offer reflecting compliance with its part of the precondition. The updated precondition offer includes, at a minimum, a media (“m=”) line, a connection (“c=”) data line, at least one current-status line, and at least one desired-status line. The SS forwards the UPDATE to the terminating gateway.
14	The terminating gateway receives confirmation that it has met its precondition (e.g., receives an RSVP RESV message) and sends a 200 (OK) UPDATE to the SS with an updated precondition answer reflecting compliance with its part of the precondition as well as the most recent updated information from the UPDATE offer. The updated answer includes, at a minimum, a media (“m=”) line, a connection (“c=”) data line, at least one current-status line, at least one desired-status line.
15	Now that the SIP preconditions have all been met, the terminating gateway sends a COT message to the EO serving TDM Party B so the EO can send a ring tone to TDM Party B.
	NOTE: If the terminating gateway did not send an IAM in Step 3, then the terminating gateway sends an IAM with the Continuity Check indicator of the Nature of Connection indicators set to “00” “Continuity check not required.”
16	The SS forwards the 200 (OK) UPDATE to the SC serving IP Party A.
17	The EO serving TDM Party B sends an ACM to the terminating gateway.
18, 19	The terminating gateway creates a 180 (Ringing) response and sends the 180 (Ringing) response to the SS, which forwards the 180 (Ringing) response to the SC serving IP Party A.
	NOTE: Signaling is not depicted between the SC serving IP Party A and the EI serving IP Party A.
20	When TDM Party B goes off-hook (i.e., answers the call), the EO serving TDM Party B sends an ANM to the terminating gateway.
21, 22	The terminating gateway creates a 200 (OK) INVITE and sends the 200 (OK) INVITE to the SS, which forwards the 200 (OK) INVITE to the SC serving IP Party A.
	NOTE: Signaling is not depicted between the SC serving IP Party A and the EI serving IP Party A.
23, 24	The SC serving IP Party A sends an ACK to the SS, which forwards the ACK to the terminating gateway.
	NOTE: Signaling is not depicted between the EI serving IP Party A and the SC serving IP Party A that initiated the call release.

The call is established now.

16.3 CALL HOLD

Party A and Party B are engaged in a conversation. Party A places the call on hold. Later, Party A resumes the call (i.e., removes the call from hold).

16.3.1 IP-to-IP Call Type

SIP-010380 See [Section 9.3.1](#), IP-to-IP Call Type.

16.3.2 TDM Bridging Call Type

SIP-010390 In the DSN TDM network today when a party engaged in an ongoing call places the call on hold or resumes the call after placing the call on hold, the only signaling exchanged in support of the call hold or call resume is between the EI and its local switch. The local switch does not transmit signaling into the network to indicate to the remote switch serving the other party to the call that a call hold or a call resume has been initiated. [Figure 16.3-1](#), TDM Bridging Call Hold, reflects this by indicating the user signaling to the local TDM switch but no signaling thereafter across the TDM network to the remote TDM switch. When the call has been placed on hold, the local TDM switch does not forward outbound bearer traffic received from the EI to the next TDM switch and does not forward inbound bearer traffic received from the network to the EI. When the call is resumed, the local TDM switch again forwards outbound bearer traffic received from the EI to the next TDM switch and forwards inbound bearer traffic received from the network to the EI.

16.3.3 TDM-to-IP Call Type

SIP-010400 In the DSN TDM network today when a party engaged in an ongoing call places the call on hold or resumes the call after placing the call on hold the only signaling exchanged in support of the call hold or call resume is between the EI and its local switch. The local switch does not transmit signaling into the network to indicate to the remote switch serving the other party to the call that a call hold or a call resume has been initiated. [Figure 16.3-2](#), TDM-to-IP Call Hold; TDM Party Places Call On Hold, reflects this by indicating the user signaling to the EO serving TDM Party A but indicating no ISUP signaling from the EO to the originating gateway. When the call has been placed on hold the local TDM switch does not forward outbound bearer traffic received from the EI to the next TDM switch and does not forward inbound bearer traffic received from the network to the EI. When the call is resumed, the local TDM switch again forwards outbound bearer traffic received from the EI to the next TDM switch and forwards inbound bearer traffic received from the network to the EI.

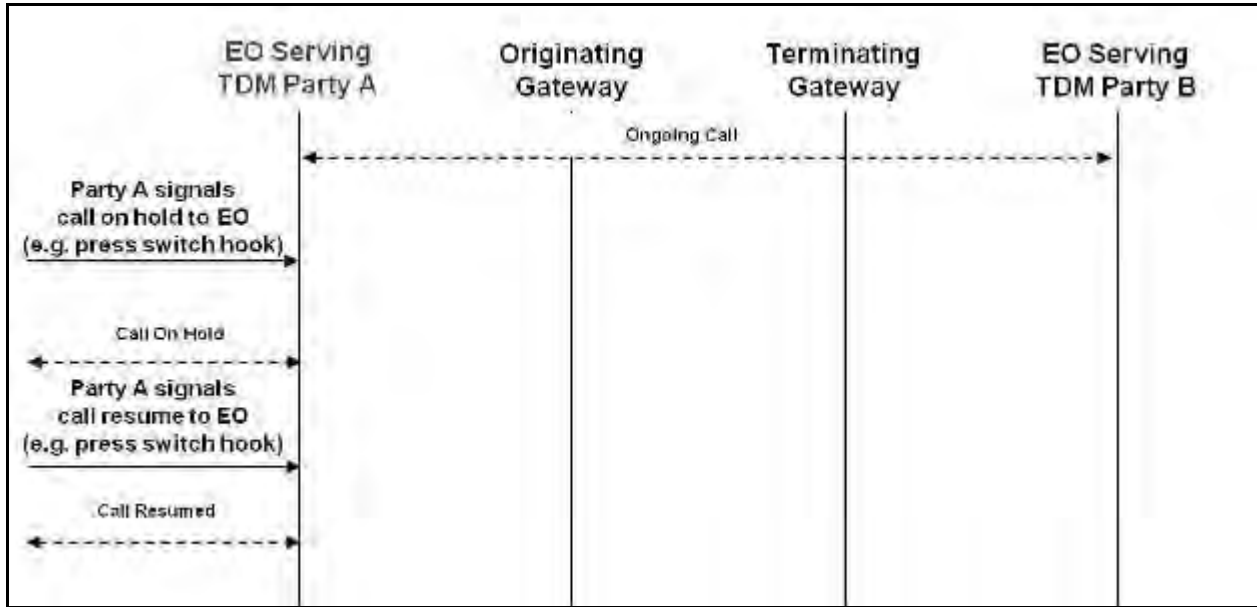

Figure 16.3-1. TDM Bridging Call Hold

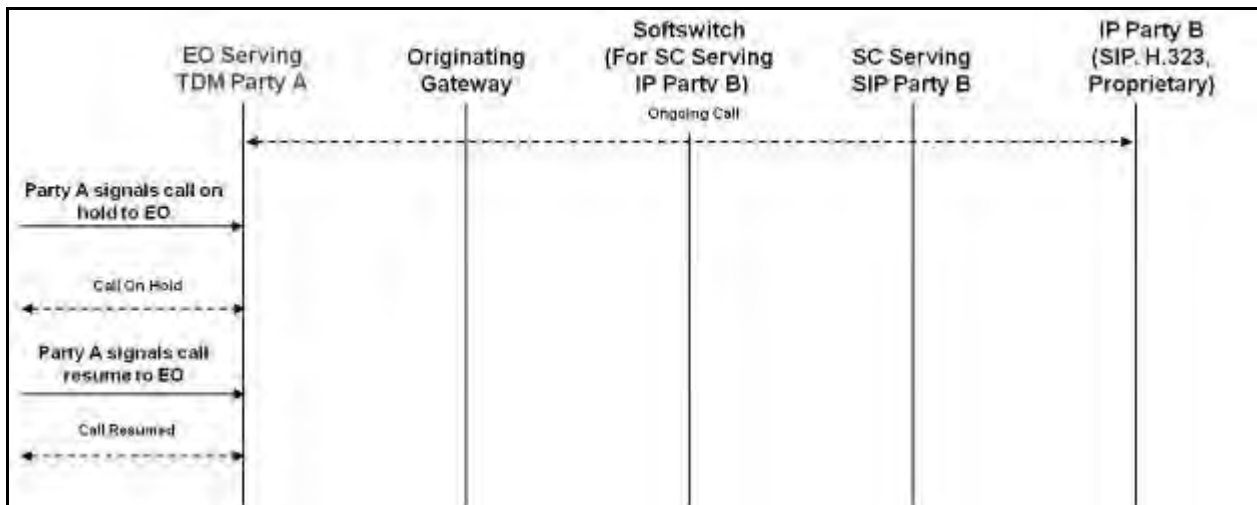

Figure 16.3-2. TDM-to-IP Call Hold; TDM Party Places Call on Hold

SIP-010410 [Figure 16.3-3](#) depicts the sequence of AS-SIP messages between the originating gateway and the SC serving IP Party B that are used when IP Party B places the current call on hold, and then resumes the call.

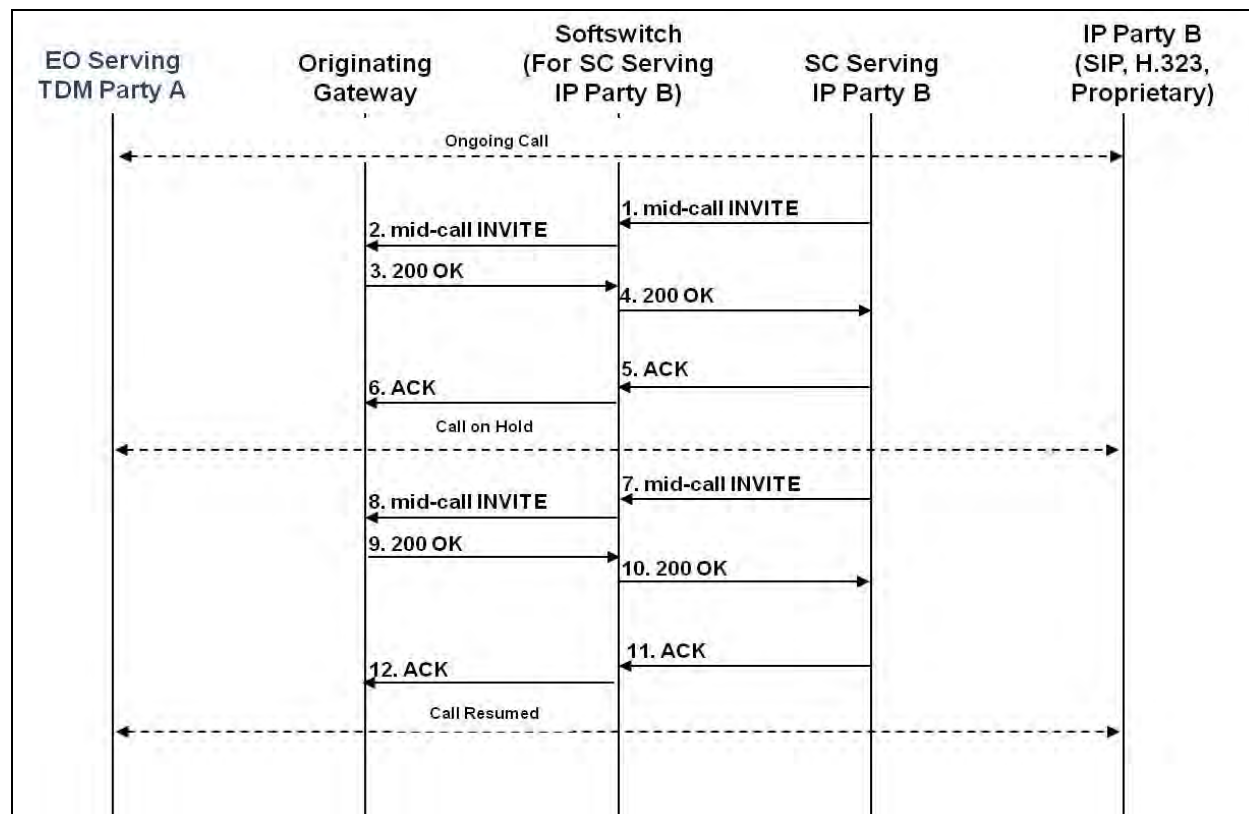

Figure 16.3-3. TDM-to-IP Call Hold; IP Party Places Call on Hold

Call Hold

STEP	INSTRUCTION
1, 2	In response to a request on the part of IP Party B, the SC serving IP Party B sends a mid-call INVITE to the SS assigned to the SC serving IP Party B. The SS forwards the mid-call INVITE to the originating gateway. The INVITE includes the attribute line “a=sendonly” or “a=inactive” if the stream had been a sendrecv media stream or “a=inactive” if the stream had been a recvonly stream.
	NOTE: The SIP UA MAY also support establishing a call hold by sending a mid-call INVITE that includes a session description that is the same as in the original request, but the “c” destination addresses for the media streams to be put on hold are set to zero: c=IN IP4 0.0.0.0.
	NOTE: Signaling is not depicted between the EI serving IP Party B and the SC serving IP Party B.
	The originating gateway does not translate the re-INVITE into TDM signaling for forwarding onto the TDM network; however, the originating gateway instructs its MG component not to forward bearer traffic for the given call that is received on the TDM channel to the IP network and not to forward RTP packets for the given call that are received from the IP network to the TDM bearer channel.
3, 4	The originating gateway sends a 200 (OK) INVITE to the SS, which forwards the 200 (OK) INVITE to the SC serving IP Party B.
	NOTE: Signaling is not depicted between the SC serving IP Party B and the EI serving IP Party B.
5, 6	The SC serving IP Party B sends an ACK to the SS, which forwards the ACK to the originating gateway.

STEP	INSTRUCTION
	NOTE: Signaling is not depicted between the EI serving IP Party B and the SC serving IP Party B.

The call is now on hold.

Call Resumed

STEP	INSTRUCTION
7, 8	In response to a request on the part of IP Party B, the SC serving Party B sends a mid-call INVITE to the SS, which forwards it to the originating gateway. The re INVITE includes the attribute line “a=sendrecv” if the stream had originally been a sendrecv media stream, or “a=recvonly” if the stream had been a recvonly stream.
	NOTE: In the case of a call hold established by setting the “c” destination address to 0.0.0.0, another re-INVITE with the original address parameter terminates the call hold.
	NOTE: Signaling is not depicted between the EI serving IP Party B and the SC serving IP Party B.
	The originating gateway does not translate the re-INVITE into TDM signaling for forwarding onto the TDM network; however, the originating gateway instructs its MG component to again forward bearer traffic for the given call that is received on the TDM channel to the IP network, and to forward RTP packets for the given call that are received from the IP network to the TDM bearer channel.
9, 10	The originating gateway sends a 200 (OK) response to the SS, which forwards the 200 (OK) response to the SC serving IP Party B.
	NOTE: Signaling is not depicted between the SC serving IP Party B and the EI serving IP Party B.
11, 12	The SC serving IP Party B sends an ACK to the SS, which forwards the ACK to the originating gateway.
	NOTE: Signaling is not depicted between the EI serving IP Party B and the SC serving IP Party B.

The call is resumed now.

[Figure 16.3-4](#), TDM-SIP Call Hold; IP Party Places Call On Hold, offers an illustrative example of the call signaling with an AS-SIP EI.

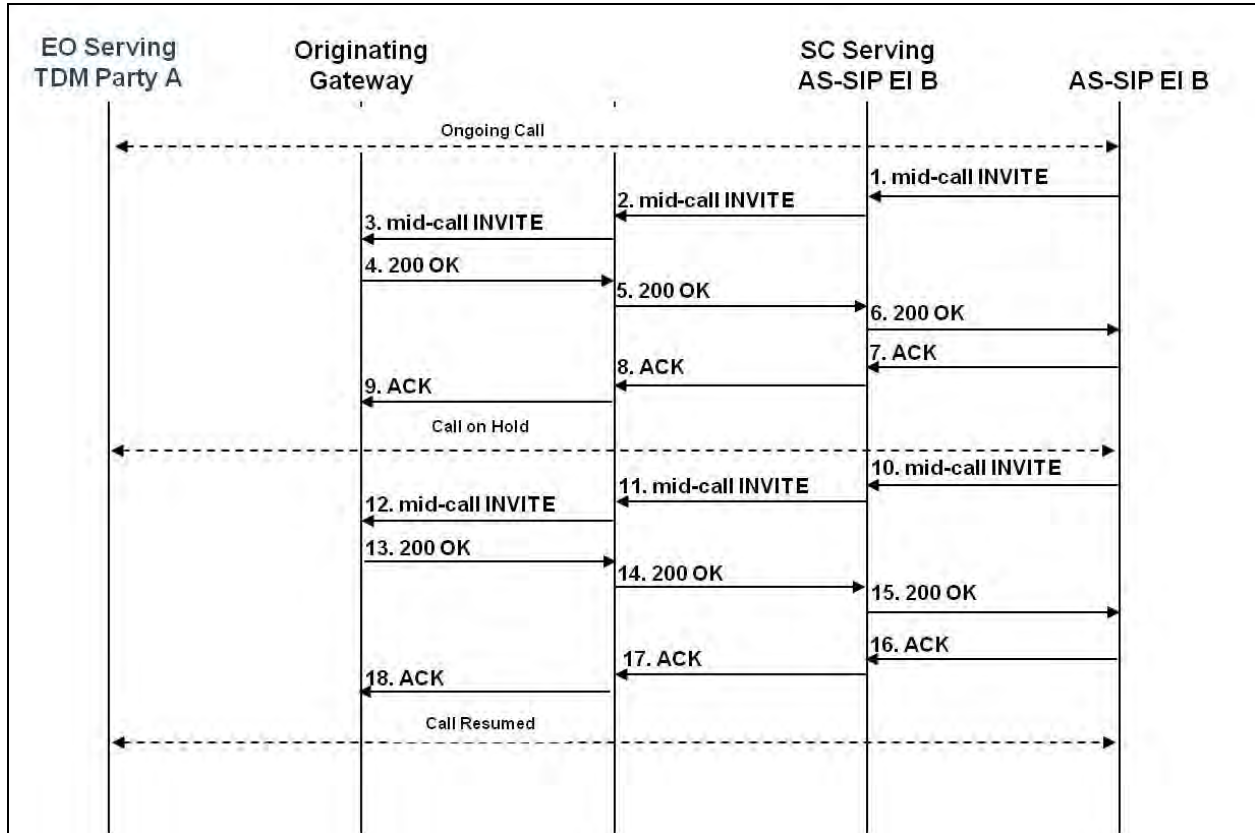

**Figure 16.3-4. TDM-SIP Call Hold; IP Party Places Call on Hold
 (AS-SIP Signaling to an AS-SIP EI Is Added for Illustrative Purposes)**

16.3.4 IP-to-TDM Call Type

SIP-010420 [Figure 16.3-5](#), IP-to-TDM Call Hold; IP Party Places Call On Hold, depicts the sequence of AS-SIP and ISUP messages between the SC serving IP Party A and the terminating gateway that are used when IP Party A places the current call on hold, and then resumes the call.

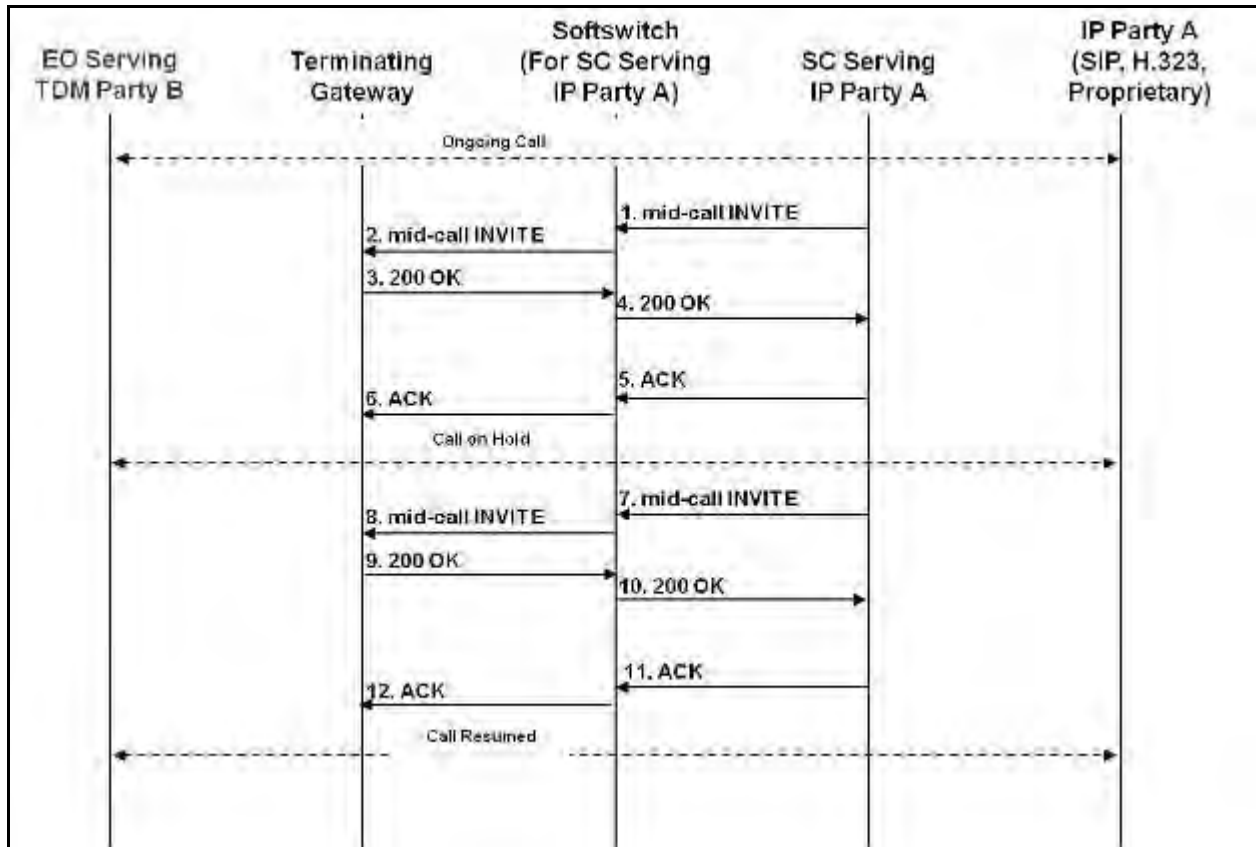

Figure 16.3-5. IP-to-TDM Call Hold; IP Party Places Call on Hold

Call Hold

STEP	INSTRUCTION
1, 2	In response to a request on the part of IP Party A, the SC serving IP Party A sends a mid-call INVITE to the SS assigned to the SC serving IP Party A. The INVITE includes the attribute line “a=sendonly” or “a=inactive” if the stream had been a sendrecv media stream, or “a=inactive” if the stream had been a recvonly stream. The SS forwards the mid-call INVITE to the terminating gateway.
	NOTE: The SIP UA MAY also support establishing a call hold by sending a mid-call INVITE that includes a session description that is the same as in the original request, but the “c” destination addresses for the media streams to be put on hold are set to zero: c=IN IP4 0.0.0.0.
	NOTE: Signaling is not depicted between the EI serving IP Party A and the SC serving IP Party A.
	The terminating gateway does not translate the re-INVITE into TDM signaling for forwarding onto the TDM network; however, the terminating gateway instructs its MG component not to forward bearer traffic for the given call that is received on the TDM channel to the IP network, and not to forward RTP packets for the given call that are received from the IP network to the TDM bearer channel.
3, 4	The terminating gateway sends a 200 (OK) response to the SS, which forwards the 200 (OK) response to the SC serving IP Party A.
	NOTE: Signaling is not depicted between the SC serving IP Party A and the EI serving IP Party A.

STEP	INSTRUCTION
5, 6	The SC serving IP Party A sends an ACK to the SS and the SS forwards the ACK to the terminating gateway.

The call is on hold now.

Call Resumed

STEP	INSTRUCTION
7, 8	In response to a request on the part of IP Party A, the SC serving IP Party A sends a mid-call INVITE to the SS, which forwards it to the terminating gateway. The re INVITE includes the attribute line “a=sendrecv” if the stream had originally been a sendrecv media stream, or “a=recvonly” if the stream had been a recvonly stream.
	NOTE: In the case of a call hold established by setting the “c” destination address to 0.0.0.0, another re-INVITE with the original address parameter terminates the call hold.
	NOTE: Signaling is not depicted between the EI serving IP Party A and the SC serving IP Party A.
	The terminating gateway does not translate the re-INVITE into TDM signaling for forwarding onto the TDM network; however the terminating gateway instructs its MG component to again forward bearer traffic for the given call that is received on the TDM channel to the IP network, and to forward RTP packets for the given call that are received from the IP network to the TDM bearer channel.
9, 10	The terminating gateway sends a 200 (OK) response to the SS, which forwards the 200 (OK) response to the SC serving IP Party A.
	NOTE: Signaling is not depicted between the SC serving IP Party A and the EI serving IP Party A.
11, 12	The SC serving IP Party A sends an ACK to the SS, which forwards the ACK to the terminating gateway.
	NOTE: Signaling is not depicted between the EI serving IP Party A and the SC serving IP Party A.

The call is resumed now.

[Figure 16.3-6](#), AS-SIP-TDM Call Hold; AS-SIP EI Places Call On Hold, offers an illustrative example of the call signaling to a standard AS-SIP EI.

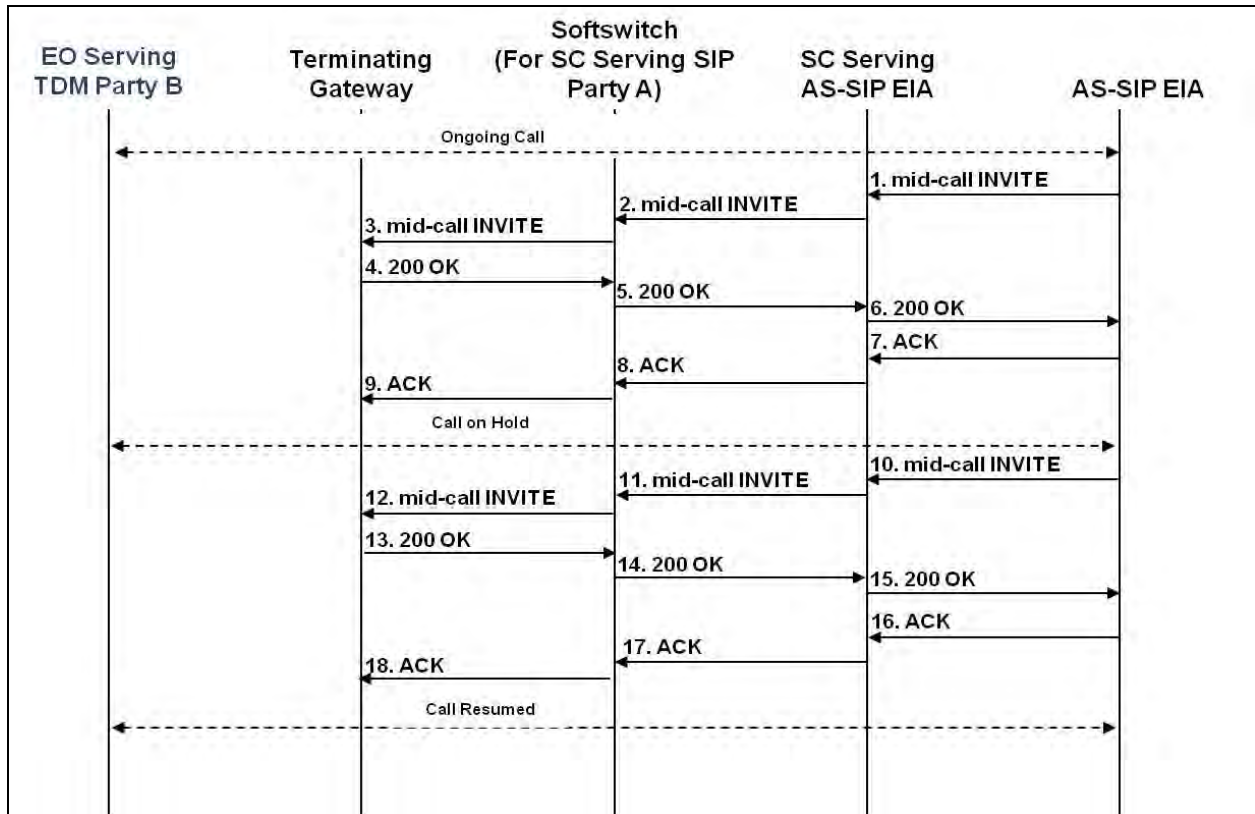

Figure 16.3-6. AS-SIP-TDM Call Hold; AS-SIP EI Places Call on Hold (AS-SIP Signaling to an AS-SIP EI Is Added for Illustrative Purposes)

SIP-010430 [Figure 16.3-7](#), IP-to-TDM Call Hold; TDM Party Places Call On Hold, is intended to depict a call hold performed by the TDM party in an IP-TDM call. As seen previously, a call hold or call resume conducted by an EI on the TDM network does not result in signaling outside the local TDM switch. [Figure 16.3-7](#) reflects this by indicating the user signaling to the EO serving TDM Party A but indicating no ISUP signaling from the EO to the originating gateway.

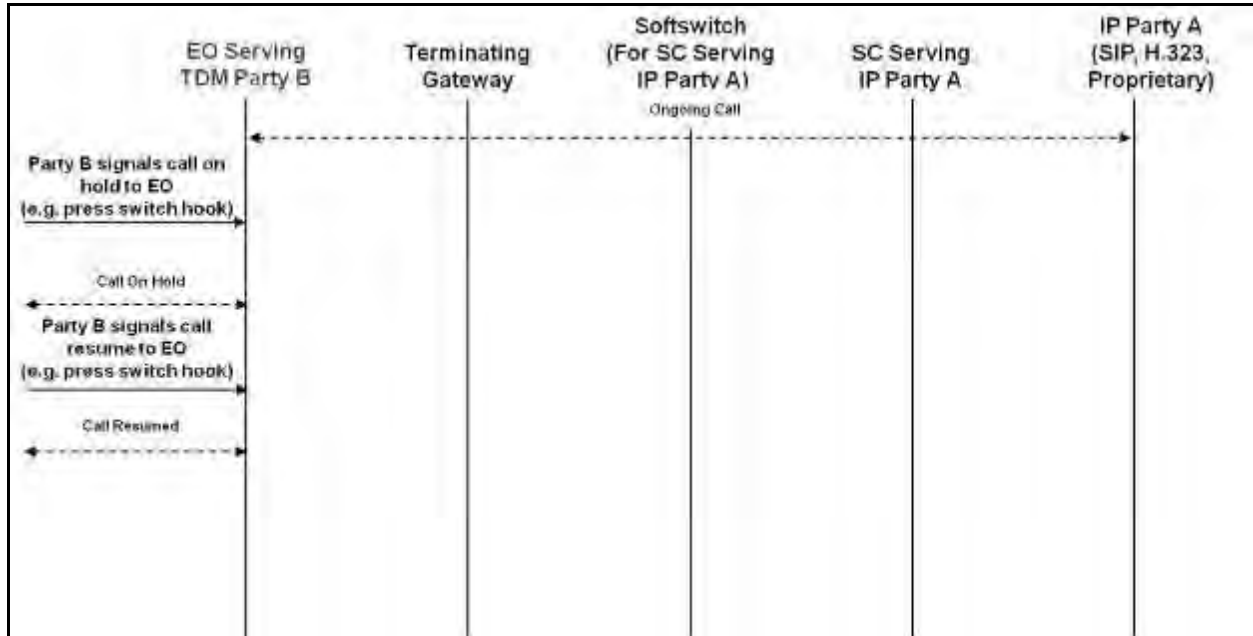

Figure 16.3-7. IP-to-TDM Call Hold; TDM Party Places Call on Hold

16.4 CALL WAITING

Party A and Party B are engaged in a conversation. Call waiting consists of one party placing the other party on hold while either accepting or resuming a call with a third party.

16.4.1 IP-to-IP Call Type

SIP-010440 See [Section 9.4.1](#), IP-to-IP Call Type.

16.4.2 TDM Bridging Call Type

SIP-010450 [Figure 16.4-1](#), TDM Bridging Call Waiting, depicts call waiting in which there is an existing session between TDM Party A and TDM Party B, and IP Party C initiates a call request to TDM Party B. Upon receiving the call waiting tone triggered by the call request from IP Party C, TDM Party B conducts a call hold on the existing session with TDM Party A and completes the call establishment with IP Party C. When TDM Party B is ready to return to the original call with TDM Party A, then TDM Party B resumes the call with TDM Party B, and IP Party C hangs up terminating the call with TDM Party B.

NOTE: When TDM Party B signals its EO to place the call with TDM Party A on hold, the EO does not transmit signaling into the TDM network to indicate the call hold. Similarly, when TDM Party B signals its EO to resume the call with TDM Party A the EO does not transmit signaling into the TDM network to indicate the call resume.

When the call is placed on hold, the local TDM switch serving TDM Party B does not forward outbound bearer traffic received from TDM Party B destined for TDM Party A and does not forward inbound bearer traffic received from remote TDM Party A to TDM Party B. When the call is resumed, the EO again forwards bearer traffic received from TDM Party A to TDM Party B and bearer traffic received from TDM Party B to TDM Party A and no longer forwards bearer traffic between TDM Party B and IP Party C.

NOTE: A valid alternative scenario for resuming the call with TDM Party A would have IP Party C terminate its call with TDM Party B whereupon TDM Party B resumes its call with TDM Party A.

To save space, the SS assigned to the SC serving IP Party C also is the terminating gateway for the call between TDM Party A and TDM Party B.

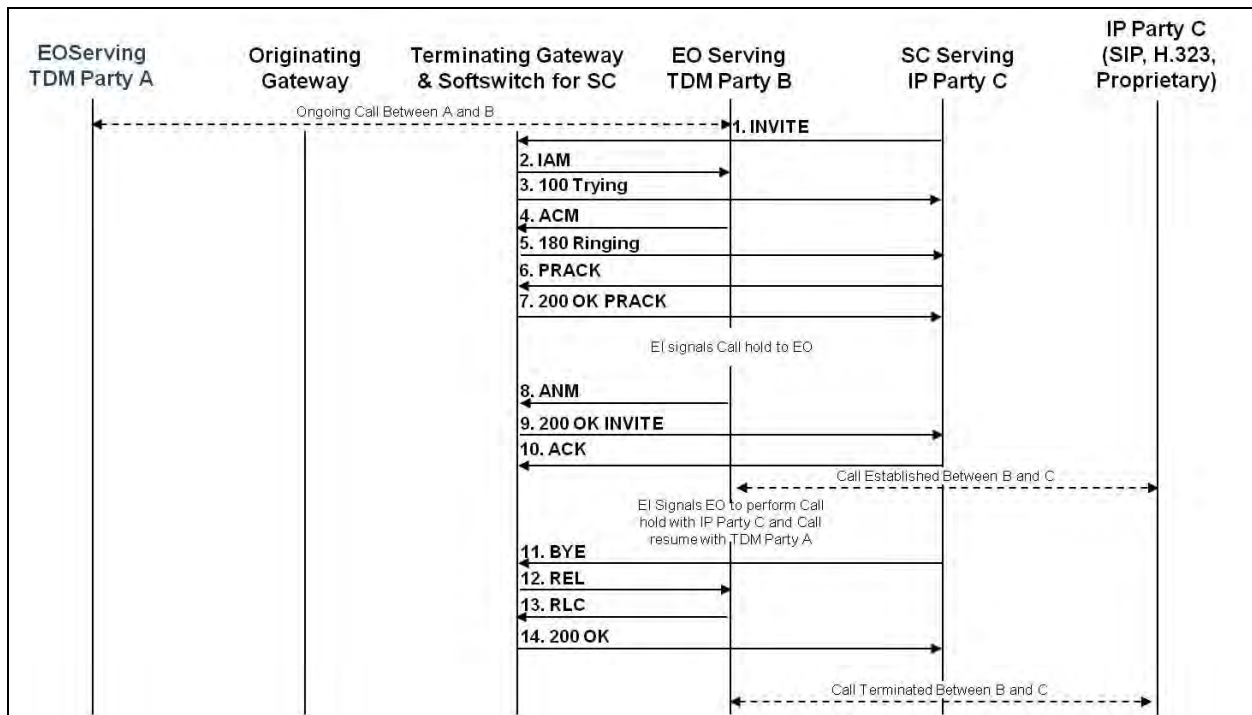

Figure 16.4-1. TDM Bridging Call Waiting

STEP	INSTRUCTION
1	Upon receiving an initial call request message from IP Party C (not depicted in the call flow diagram), the SC serving IP Party C sends an INVITE to its SS, which in this example also happens to be the terminating gateway for the EO serving TDM Party B.
	NOTE: Signaling is not depicted between the EI serving IP Party C and the SC serving IP Party C.
2	The terminating gateway receives the INVITE request and sends an IAM to the EO serving TDM Party B.
3	The terminating gateway sends a 100 (Trying) response to the SC serving IP Party C.

The original call between TDM Party A and TDM Party B is on hold now.

STEP	INSTRUCTION
4	TDM Party B receives the call waiting tone and the EO serving TDM Party B sends an ACM to the terminating gateway.
5	The terminating gateway translates the ACM to a 180 (Ringing) response and sends the 180 (Ringing) response to the SC serving IP Party C.
	NOTE: Signaling is not depicted between the SC serving IP Party C and the EI serving IP Party C.
6	The SC serving IP Party C sends a PRACK to the terminating gateway.
7	The terminating gateway sends a 200 (OK) PRACK to the SC serving IP Party C.
	Call Hold TDM Party B signals a call hold to its local EO. The local EO ceases forwarding any bearer traffic between TDM Party B and TDM Party A.

The original call between TDM Party A and TDM Party B is on hold now.

STEP	INSTRUCTION
8	The EO serving TDM Party B sends an ANM to the terminating gateway.
9	The terminating gateway receives the ANM and sends a 200 (OK) response to the SC serving IP Party C.
	NOTE: Signaling is not depicted between the SC serving IP Party C and the EI serving IP Party C.
10	The SC serving IP Party C sends an ACK to the terminating gateway.
	NOTE: Signaling is not depicted between the EI serving IP Party C and the SC serving IP Party C.

The call between IP Party C and TDM Party B is established now.

STEP INSTRUCTION

STEP	INSTRUCTION
Call Hold C Call Resume A	TDM Party B signals its local EO to hold the call with IP Party C and resume the call with TDM Party A.
	The local EO disables forwarding of bearer traffic between TDM Party B and IP Party C and reenables forwarding of bearer traffic between TDM Party B and TDM Party A.

The call between TDM Party A and TDM Party B is resumed.

STEP	INSTRUCTION
11	The SC serving IP Party C sends a BYE request to the terminating gateway.
	NOTE: Signaling is not depicted between the EI serving IP Party C and the SC serving IP Party C.
12	When the terminating gateway receives the BYE request, the terminating gateway sends a REL to the EO serving TDM Party B.
13	The EO serving TDM Party B sends a RLC to the terminating gateway.
14	The terminating gateway sends a 200 (OK) response to the SC serving IP Party C.
	NOTE: Signaling is not depicted between the SC serving IP Party C and the EI serving IP Party C.

The call between IP Party C and TDM Party B has been terminated.

Figure 16.4-2 offers an illustrative example of the call signaling when IP Party C is a standard SIP EI.

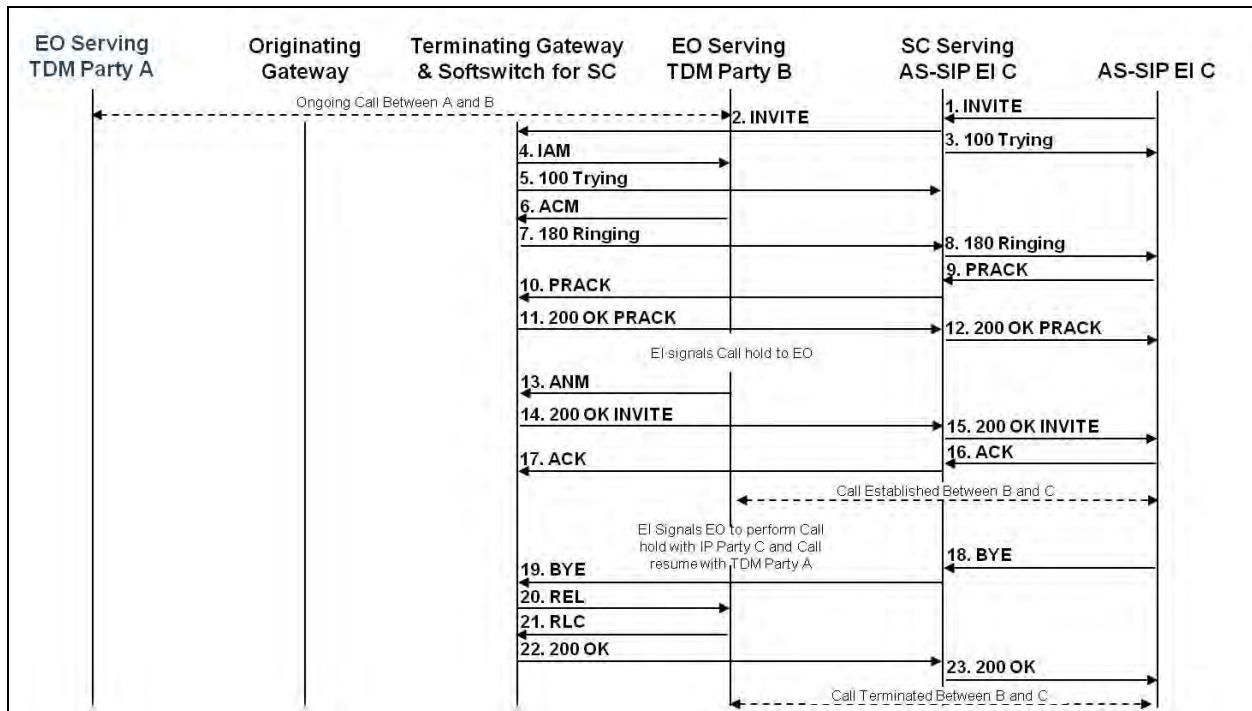

Figure 16.4-2. TDM Bridging Call Waiting (AS-SIP Signaling to a Third-Party AS-SIP End Instrument Is Depicted for Illustrative Purposes)

16.4.3 TDM-to-IP Call Type

SIP-010460 Figure 16.4-3 depicts the sequence of AS-SIP messages used to place the current TDM-IP call on hold to accept a call from a third party C, and to terminate the call with the third party C to resume the original call. (IP party performs the call waiting.)

NOTE: When the originating gateway receives the SIP message indicating call hold, the originating gateway instructs its MG to cease forwarding bearer traffic between TDM Party A and IP Party B and vice versa. However, the originating gateway does not translate the SIP signaling message indicating call hold to ISUP as the DSN TDM network does not signal call hold over the network. Similarly, when the originating gateway receives the SIP message indicating call resume, the originating gateway instructs its MG to resume forwarding bearer traffic between TDM Party A and IP Party B and vice versa. However, the originating gateway does not translate the SIP signaling message indicating call resume into an ISUP message.

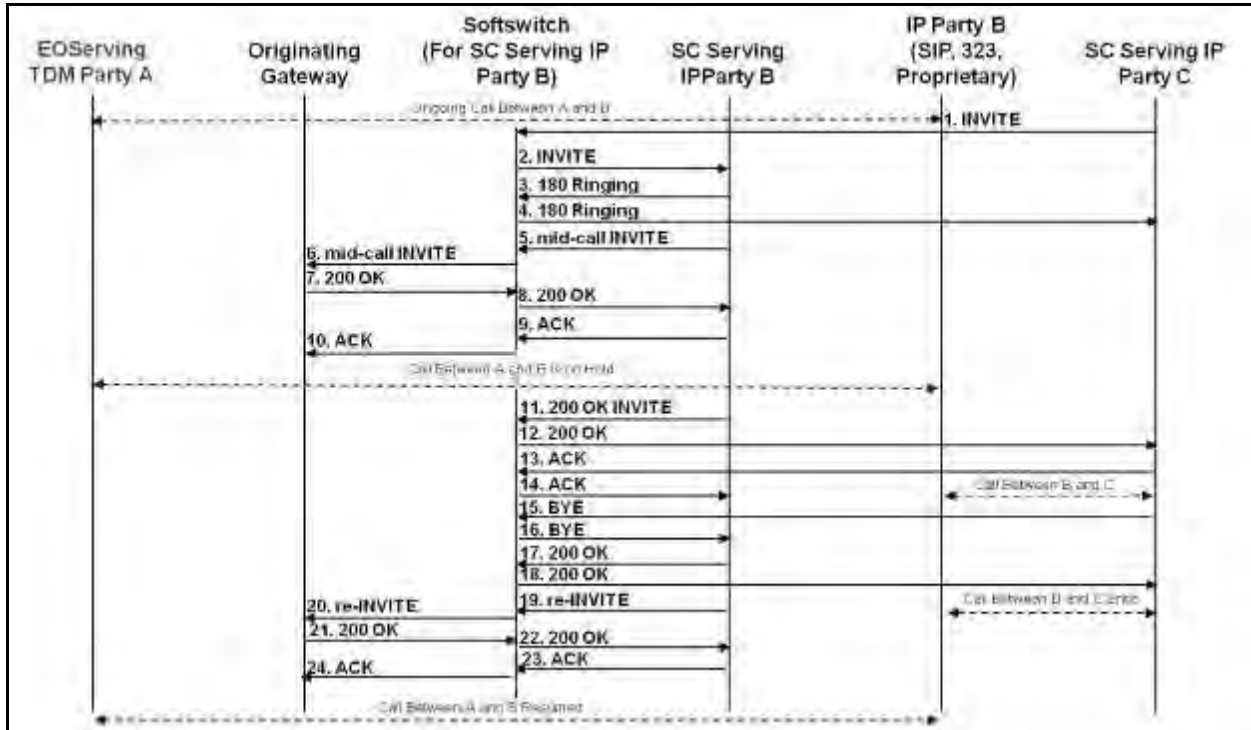

Figure 16.4-3. TDM-to-IP Call Waiting (Performed at IP Party B)

In this scenario when IP Party B and IP Party C have completed their call, IP Party C terminates the call with IP Party B, and then IP Party B resumes its call with TDM Party A.

NOTE: A valid alternative scenario for resuming the call with TDM Party A would have IP Party B place IP Party C on hold, and resume the call with TDM Party A where IP Party C disconnects the call with IP Party B.

The same SS is assigned to the SC serving IP Party B and to the SC serving IP Party C.

STEP	INSTRUCTION
1	Upon receiving an initial call request message from IP Party C (not depicted in the call flow diagram), the SC serving IP Party C sends an INVITE to the SS assigned to the SC serving IP Party B. NOTE: Signaling is not depicted between the EI serving IP Party C and the SC serving IP Party C.
2	The SS sends the INVITE to the SC serving IP Party B. NOTE: Signaling is not depicted between the SC serving IP Party B and the EI serving IP Party B.
3, 4	The SC serving IP Party B sends a 180 (Ringing) response to the SS, which forwards the 180 (Ringing) response to the SC serving IP Party C. NOTE: Signaling is not depicted between the EI serving IP Party B and the SC serving IP Party B. NOTE: Signaling is not depicted between the SC serving IP Party C and the EI serving IP Party C.
5, 6	The SC serving IP Party B sends a mid-call INVITE to the SS, which forwards the mid-call INVITE to the originating gateway. The mid-call INVITE includes the attribute line "a=sendonly" or "a=inactive" if the stream had been a sendrecv media stream, or "a=inactive" if the stream had been a recvonly stream.

STEP	INSTRUCTION
	NOTE: The SC serving IP Party B MUST also support establishing a call hold by sending a mid-call INVITE that includes a session description that is the same as in the original request, but the “c” destination addresses for the media streams to be put on hold are set to zero: c=IN IP4 0.0.0.0.
	NOTE: Signaling is not depicted between the EI serving IP Party B and the SC serving IP Party B.
	The originating gateway instructs its MG to cease forwarding bearer traffic between IP Party B and TDM Party A and vice versa.
7, 8	The originating gateway sends a 200 (OK) INVITE to the SS, which forwards the 200 (OK) INVITE to the SC serving IP Party B.
	NOTE: Signaling is not depicted between the SC serving IP Party B and the EI serving IP Party B.
9, 10	The SC serving IP Party B sends an ACK to the SS, which forwards the ACK to the originating gateway.
	NOTE: Signaling is not depicted between the EI serving IP Party B and the SC serving IP Party B.

The original call between TDM Party A and IP Party B is on hold now.

STEP	INSTRUCTION
11, 12	The SC serving IP Party B sends a 200 (OK) response to the SS, which forwards the 200 (OK) response to the SC serving IP Party C.
	NOTE: Signaling is not depicted between the EI serving IP Party B and the SC serving IP Party B.
	NOTE: Signaling is not depicted between the SC serving IP Party C and the EI serving IP Party C.
13, 14	The SC serving IP Party C sends an ACK to the SS, which forwards the ACK to the SC serving IP Party B.
	NOTE: Signaling is not depicted between the EI serving IP Party C and the SC serving IP Party C.
	NOTE: Signaling is not depicted between the SC serving IP Party B and the EI serving IP Party B.

The call between IP Party C and IP Party B is now established.

STEP	INSTRUCTION
15, 16	When IP Party C terminates the session with IP Party B, then the SC serving IP Party C sends a BYE request to the SS, which forwards the BYE request to the SC serving IP Party B.
	NOTE: Signaling is not depicted between the EI serving IP Party C and the SC serving IP Party C that initiated the call release.
	NOTE: Signaling is not depicted between the SC serving IP Party B and the EI serving IP Party B.
17, 18	The SC serving IP Party B sends a 200 (OK) response to the SS, which forwards the 200 (OK) response to the SC serving IP Party C.
	NOTE: Signaling is not depicted between the EI serving IP Party B and the SC serving IP Party B.
	NOTE: Signaling is not depicted between the SC serving IP Party C and the EI serving IP Party C.

Now the call between IP Party C and IP Party B is terminated.

STEP	INSTRUCTION
19, 20	The SC serving IP Party B sends a mid-call re-INVITE to the SS, which forwards the mid-call re-INVITE to the originating gateway. The mid-call re-INVITE includes the attribute line “a=sendrecv” if the stream had originally been a sendrecv media stream, or “a=recvonly” if the stream had been a recvonly stream.
	NOTE: In the case of a call hold established by setting the “c” destination address to 0.0.0.0, another re-INVITE with the original address parameter terminates the call hold.
	NOTE: Signaling is not depicted between the EI serving IP Party B and the SC serving IP Party B.
	The originating gateway instructs its MG to resume forwarding bearer traffic between IP Party B and TDM Party A and vice versa.
21, 22	The originating gateway sends a 200 (OK) response to the SS, which forwards the 200 (OK) response to the SC serving IP Party B.
	NOTE: Signaling is not depicted between the SC serving IP Party B and the EI serving IP Party B.
23, 24	The SC serving IP Party B sends an ACK to the SS, which forwards the ACK to the originating gateway.
	NOTE: Signaling is not depicted between the EI serving IP Party B and the SC serving IP Party B.

The original call between TDM Party A and IP Party B is now resumed.

[Figure 16.4-4](#), TDM-AS-SIP Call Waiting (Performed at AS-SIP EI B), offers an illustrative example of the call signaling when IP Party B is a standard AS-SIP EI.

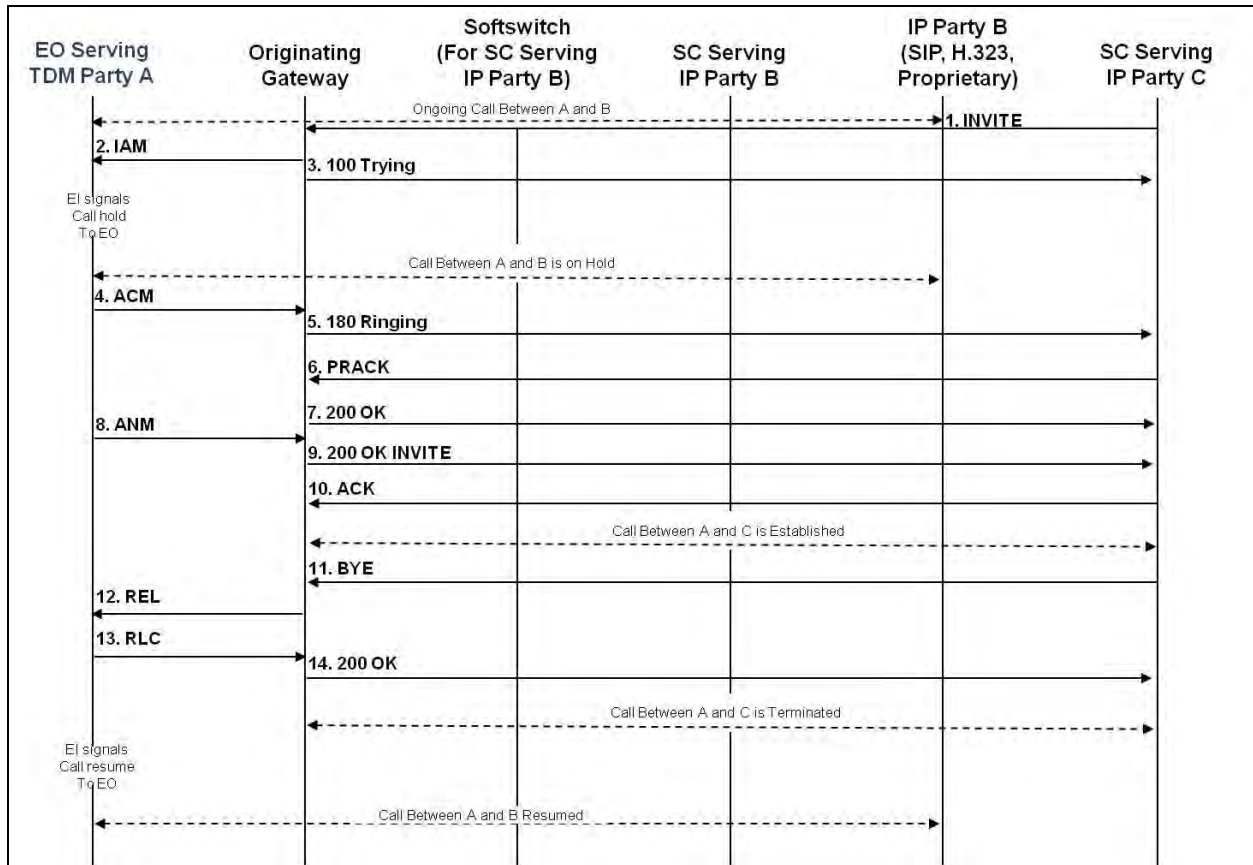

Figure 16.4-5. TDM-to-IP Call Waiting (Performed at TDM Party A)

NOTE: When TDM Party A signals its EO to place the call with IP Party B on hold, the EO does not transmit signaling; therefore, to the originating gateway; and consequently, there is no signaling interworking for call hold onto the IP network. Similarly, when TDM Party A signals its EO to resume the call with IP Party B, there is no signaling interworking with the IP network.

NOTE: A valid alternative scenario for resuming the call with IP Party B would have TDM Party A place the call with IP Party C on hold, and resume the call with IP Party B where IP Party C terminates its call with TDM Party A.

The SS assigned to the SC serving IP Party C also is the originating gateway for the call between TDM Party A and IP Party B.

STEP	INSTRUCTION
1	Upon receiving an initial call request message from IP Party C (not depicted in the call flow diagram), the SC serving IP Party C sends an INVITE to its assigned SS, which is also the originating gateway.
	NOTE: Signaling is not depicted between the EI serving IP Party C and the SC serving IP Party C.
2	The originating gateway receives the INVITE and sends an IAM to the EO serving TDM Party A.
3	The originating gateway sends a 100 (Trying) response code to the SC serving IP Party C.

STEP	INSTRUCTION
	NOTE: Signaling is not depicted between the SC serving IP Party C and the EI serving IP Party C.

The original call between TDM Party A and IP Party B in on hold now.

STEP	INSTRUCTION
4	TDM Party A receives the call waiting tone and the EO serving TDM Party A sends an ACM to the originating gateway.
5	The originating gateway receives the ACM and sends a 180 (Ringing) response to the SC serving IP Party C.
	NOTE: Signaling is not depicted between the SC serving IP Party C and the EI serving IP Party C.
6	The SC serving IP Party C sends a PRACK to the originating gateway.
7	The originating gateway sends 200 (OK) PRACK to the SC serving IP Party C.
Call Hold	TDM Party A signals call hold to its local EO. The local EO ceases forwarding any bearer traffic between TDM Party A and IP Party B. The original call between TDM Party A and TDM Party B is now on hold.
8	The EO serving TDM Party A sends an ANM to the originating gateway.
9	The originating gateway receives the ANM and sends a 200 (OK) response to the SC serving IP Party C.
	NOTE: Signaling is not depicted between the SC serving IP Party C and the EI serving IP Party C.
10	The SC serving IP Party C sends an ACK to the originating gateway.
	NOTE: Signaling is not depicted between the EI serving IP Party C and the SC serving IP Party C.

The call between TDM Party A and IP Party C is established now.

STEP	INSTRUCTION
11	When IP Party C is ready to terminate the call with TDM Party A, then the SC serving IP Party C sends a BYE request to the originating gateway.
	NOTE: Signaling is not depicted between the EI serving IP Party C and the SC serving IP Party C.
12	The originating gateway sends a REL to the EO serving TDM Party A.
13	The EO serving TDM Party A sends an RLC to the originating gateway.
14	The originating gateway sends a 200 (OK) response to the SC serving IP Party C.
	NOTE: Signaling is not depicted between the SC serving IP Party C and the EI serving IP Party C.

The call between IP Party C and TDM Party A is now terminated.

STEP	INSTRUCTION
Call Resume	TDM Party A signals the call resume to its local EO. The local EO reenables forwarding of bearer traffic between TDM Party A and IP Party B.

The original call between TDM Party A and IP Party B is now resumed.

16.4.4 IP-to-TDM Call Type

SIP-010480 [Figure 16.4-6](#), IP-to-TDM Call Waiting (Performed at TDM Party B), depicts call waiting in which TDM Party B conducts a call hold on the existing session with IP Party A upon receiving the call waiting tone triggered by a call request from IP Party C. TDM Party B and IP Party C complete call setup and engage in a conversation. Then IP Party C terminates the call with TDM Party B, and TDM Party B resumes its call with IP Party A.

NOTE: When TDM Party B signals its EO to place the call with IP Party A on hold, the EO does not transmit signaling; therefore, to the originating gateway, and consequently, there is no signaling interworking for call hold onto the IP network. Similarly, when TDM Party B signals its EO to resume the call with IP Party A, there is no signaling interworking with the IP network.

NOTE: A valid alternative scenario for resuming the call with IP Party A would have TDM Party B place the call with IP Party C on hold, and resume the call with IP Party A where IP Party C terminates its call with TDM Party B.

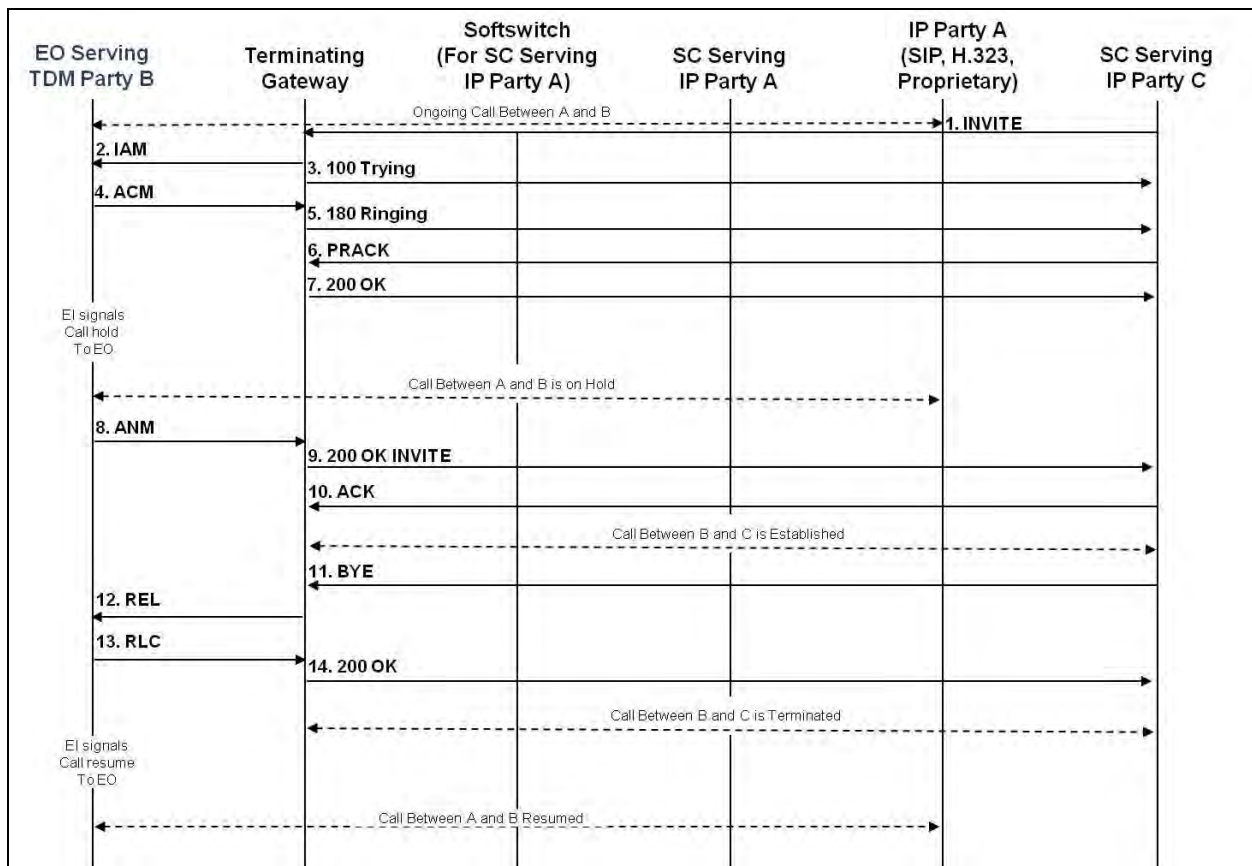

Figure 16.4-6. IP-to-TDM Call Waiting (Performed at TDM Party B)

The SS assigned to the SC serving IP Party C also is the terminating gateway for the call between TDM Party A and IP Party B.

STEP	INSTRUCTION
1	Upon receiving an initial call request message from IP Party C (not depicted in the call flow diagram), the SC serving IP Party C sends an INVITE to the terminating gateway, which is also the SS for IP Party C.
	NOTE: Signaling is not depicted between the EI serving IP Party C and the SC serving IP Party C.
2	The terminating gateway receives the INVITE and sends an IAM to the EO serving TDM Party B.
3	The terminating gateway sends a 100 (Trying) response to the SC serving IP Party C.
	NOTE: Signaling is not depicted between the SC serving IP Party C and the EI serving IP Party C.

The original call between IP Party A and TDM Party B is on hold now.

STEP	INSTRUCTION
4	TDM Party B receives the call waiting tone and the EO serving TDM Party B sends an ACM to the terminating gateway.
5	The terminating gateway receives the ACM and sends a 180 (Ringing) to the SC serving IP Party C.
	NOTE: Signaling is not depicted between the SC serving IP Party C and the EI serving IP Party C.
6	The SC serving IP Party C sends a PRACK to the terminating gateway.
7	The terminating gateway sends a 200 OK PRACK response to the SC serving IP Party C.
Call Hold	TDM Party B signals call hold to its local EO. The local EO ceases forwarding any bearer traffic between TDM Party B and IP Party A.
8	The EO serving TDM Party B sends an ANM to the terminating gateway.
9	The terminating gateway receives the ANM and sends a 200 (OK) response to the SC serving IP Party C.
	NOTE: Signaling is not depicted between the SC serving IP Party C and the EI serving IP Party C.
10	The SC serving IP Party C sends an ACK to the terminating gateway.
	NOTE: Signaling is not depicted between the EI serving IP Party C and the SC serving IP Party C.

The call between TDM Party B and IP Party C is established now.

STEP	INSTRUCTION
11	When IP Party C terminates the session with TDM Party B, then the SC serving IP Party C sends a BYE request to the terminating gateway.
	NOTE: Signaling is not depicted between the EI serving IP Party C and the SC serving IP Party C.
12	The terminating gateway receives the BYE request and sends a REL to the EO serving TDM Party B.
13	The EO serving TDM Party B sends an RLC to the terminating gateway.
	NOTE: Signaling is not depicted between the SC serving IP Party C and the EI serving IP Party C.
14	The terminating gateway sends a 200 (OK) response to the SC serving IP Party C.
	NOTE: Signaling is not depicted between the SC serving IP Party C and the EI serving IP Party C.

The call between IP Party C and TDM Party B is now terminated.

STEP	INSTRUCTION
Call Resume	TDM Party B signals call resume to its local EO. The local EO re-enables forwarding of bearer traffic between TDM Party B and IP Party A.

The original call between IP Party A and TDM Party B is now resumed.

SIP-010490 [Figure 16.4-7](#), IP-to-TDM Call Waiting (Performed at IP Party A), depicts the sequence of AS-SIP messages used to place the current IP-TDM call on hold to accept a call from a third Party C, and to terminate the call with the third Party C to resume the original call. (IP Party A performs the call waiting.)

NOTE: When the terminating gateway receives the SIP message indicating call hold, the terminating gateway instructs its MG to cease forwarding bearer traffic between TDM Party B and IP Party A and vice versa. However, the terminating gateway does not translate the SIP signaling message indicating call hold to ISUP because the DSN TDM network does not signal call hold over the network. Similarly, when the terminating gateway receives the SIP message indicating call resume, the terminating gateway instructs its MG to resume forwarding bearer traffic between TDM Party B and IP Party A and vice versa. However, the terminating gateway does not translate the SIP signaling message indicating call resume into an ISUP message.

NOTE: A valid alternative scenario for resuming the call with TDM Party B would have IP Party A place the call with IP Party C on hold and resume the call with TDM Party B where IP Party C terminates its call with IP Party A.

The same SS is assigned to the SC serving IP Party A and to the SC serving IP Party C.

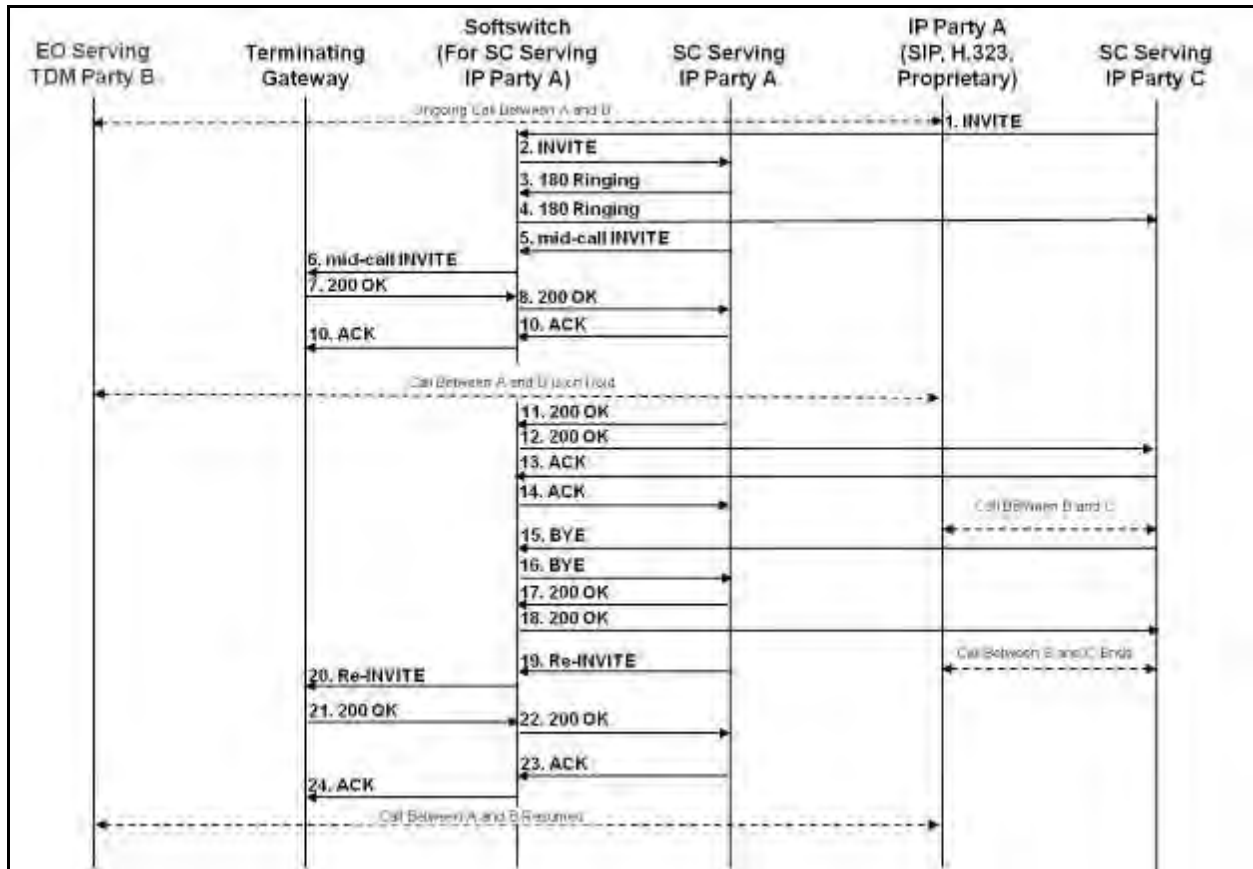

Figure 16.4-7. IP-to-TDM Call Waiting (Performed at IP Party A)

STEP	INSTRUCTION
1	Upon receiving an initial call request message from IP Party C (not depicted in the call flow diagram), the SC serving IP Party C sends an INVITE to the SS assigned to the SC serving IP Party A. NOTE: Signaling is not depicted between the EI serving IP Party C and the SC serving IP Party C.
2	The SS sends the INVITE to the SC serving IP Party A. NOTE: Signaling is not depicted between the SC serving IP Party A and the EI serving IP Party A.
3, 4	The SC serving IP Party A sends a 180 (Ringing) response to the SS, which forwards the 180 (Ringing) response to the SC serving IP Party C. NOTE: Signaling is not depicted between the EI serving IP Party A and the SC serving IP Party A. NOTE: Signaling is not depicted between the SC serving IP Party C and the EI serving IP Party C.
5, 6	The SC serving IP Party A sends a mid-call INVITE to the SS, which forwards the mid-call INVITE to the terminating gateway. The mid-call INVITE includes the attribute line “a=sendonly” or “a=inactive” if the stream had been a sendrecv media stream, or “a=inactive” if the stream had been a recvonly stream. The terminating gateway instructs its MG to cease forwarding bearer traffic between IP Party B and TDM Party A and vice versa.

STEP	INSTRUCTION
	NOTE: The SC serving IP Party A MUST also support establishing a call hold by sending a mid-call INVITE that includes a session description that is the same as in the original request, but the “c” destination addresses for the media streams to be put on hold are set to zero: c=IN IP4 0.0.0.0.
	NOTE: Signaling is not depicted between the EI serving IP Party A and the SC serving IP Party A.
7, 8	The terminating gateway sends a 200 (OK) INVITE to the SS, which forwards the 200 (OK) INVITE to the SC serving IP Party A.
	NOTE: Signaling is not depicted between the SC serving IP Party A and the EI serving IP Party A.
9, 10	The SC serving IP Party A sends an ACK to the SS, which forwards the ACK to the terminating gateway.
	NOTE: Signaling is not depicted between the EI serving IP Party A and the SC serving IP Party A.

The original call between IP Party A and TDM Party B is on hold now.

STEP	INSTRUCTION
11, 12	The SC serving IP Party A sends a 200 (OK) response to the SS, which forwards the 200 (OK) response to the SC serving IP Party C.
	NOTE: Signaling is not depicted between the EI serving IP Party A and the SC serving IP Party A.
	NOTE: Signaling is not depicted between the SC serving IP Party C and the EI serving IP Party C.
13, 14	The SC serving IP Party C sends an ACK to the SS, which forwards the ACK to the SC serving IP Party A.
	NOTE: Signaling is not depicted between the EI serving IP Party C and the SC serving IP Party C.
	NOTE: Signaling is not depicted between the SC serving IP Party A and the EI serving IP Party A.

The call between IP Party C and IP Party A is established now.

STEP	INSTRUCTION
15, 16	When IP Party C terminates the session with IP Party A, then the SC serving IP Party C sends a BYE request to the SS, which forwards the BYE request to the SC serving IP Party A.
	NOTE: Signaling is not depicted between the EI serving IP Party C and the SC serving IP Party C that initiated the call release.
	NOTE: Signaling is not depicted between the SC serving IP Party A and the EI serving IP Party A.
17, 18	The SC serving IP Party A sends a 200 (OK) response to the SS, which forwards the 200 (OK) response to the SC serving IP Party C.
	NOTE: Signaling is not depicted between the EI serving IP Party A and the SC serving IP Party A.
	NOTE: Signaling is not depicted between the SC serving IP Party C and the EI serving IP Party C.

The call between IP Party C and IP Party A is terminated now.

STEP	INSTRUCTION
19, 20	The SC serving IP Party A sends a mid-call re-INVITE to the SS, which forwards the mid-call re-INVITE to the terminating gateway. The mid-call re-INVITE includes the attribute line "a=sendrecv" if the stream had originally been a sendrecv media stream, or "a=recvonly" if the stream had been a recvonly stream.
	The terminating gateway instructs its MG to resume forwarding bearer traffic between IP Party B and TDM Party A and vice versa.
	NOTE: In the case of a call hold established by setting the "c" destination address to 0.0.0.0, another re-INVITE with the original address parameter terminates the call hold.
	NOTE: Signaling is not depicted between the EI serving IP Party A and the SC serving IP Party A.
21, 22	The terminating gateway sends a 200 (OK) response to the SS, which forwards the 200 (OK) response to the SC serving IP Party A.
	NOTE: Signaling is not depicted between the SC serving IP Party A and the EI serving IP Party A.
23, 24	The SC serving IP Party A sends an ACK to the SS, which forwards the ACK to the terminating gateway.
	NOTE: Signaling is not depicted between the EI serving IP Party A and the SC serving IP Party A.

The original call between IP Party A TDM and Party B is resumed now.

[Figure 16.4-8](#), AS-SIP-TDM Call Waiting (Performed at AS-SIP EI A), offers an illustrative example of the call signaling when IP Party A is a standard AS-SIP EI.

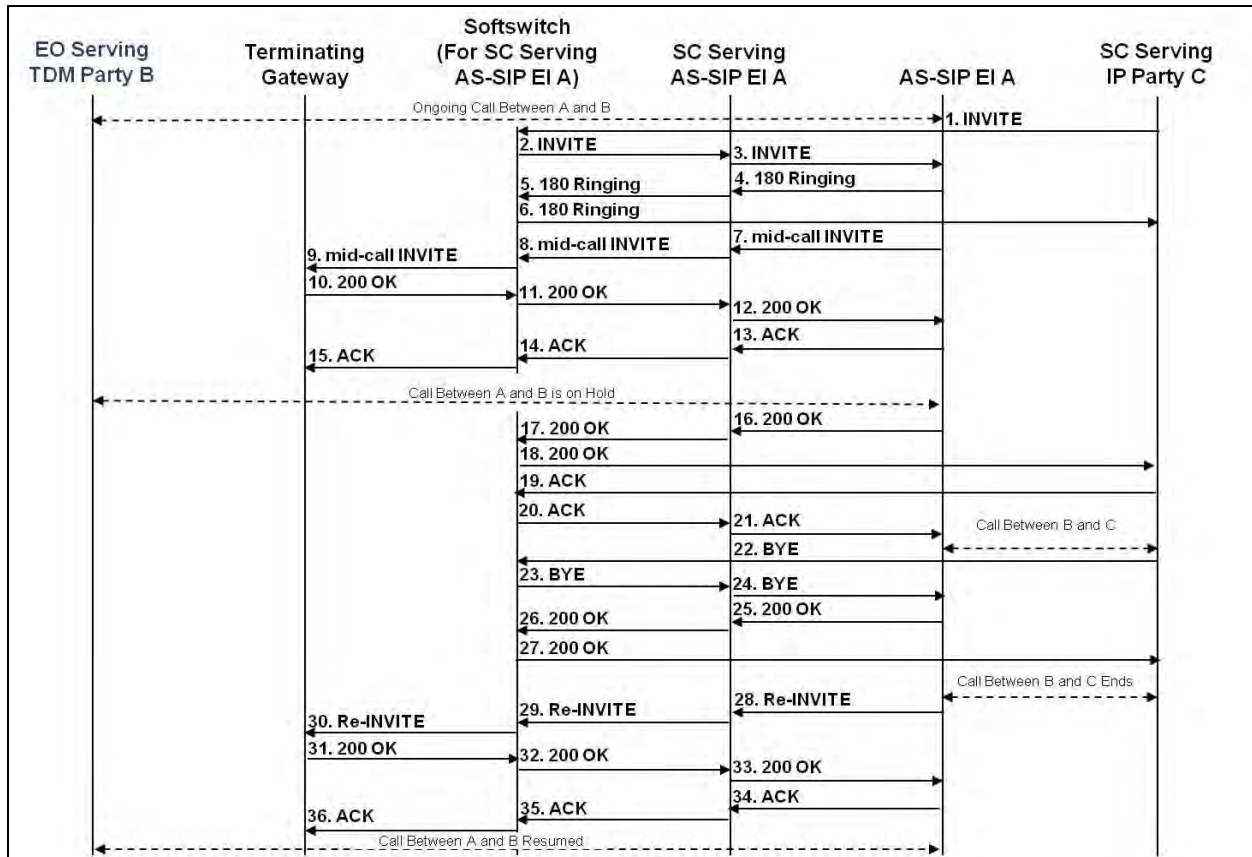

**Figure 16.4-8. AS-SIP-TDM Call Waiting (Performed at AS-SIP EI A)
(AS-SIP Signaling to AS-SIP EI A Is Depicted for Illustrative Purposes)**

16.5 CALL FORWARD

16.5.1 Call Forward (Unconditional)

A user instructs that call requests to a particular telephone number be routed to a different predefined telephone number. In the following call flow diagrams, User B has instructed that call requests addressed to User B's telephone number at location 1 be rerouted to a different telephone number for an EI at location 2.

SIP-010500 As specified in [Section 4.6](#), SIP URI and Mapping of Telephony Number Into SIP URI, and [Section 12.3](#), SIP URI and Mapping of Telephony Number Into SIP URI, the addressing format for the SIP messages MUST be a SIP URI having a userinfo part that is either a full 10-digit number from the DSN worldwide numbering plan, which may include a phone-context descriptor or an E.164 encoded telephone number and having a "user=phone" field appended to the URI.

16.5.1.1 IP-to-IP Call Type

SIP-010510 See [Section 9.5.1.1](#), IP-to-IP Call Type.

16.5.1.2 TDM Bridging Call Type

SIP-010520 [Figure 16.5-1](#), TDM Bridging Call Forward Unconditional, depicts the sequence of AS-SIP and ISUP messages between the EO serving TDM Party A and the EO serving TDM Party B that are involved in the unconditional forwarding of a call request intended for TDM Party B at location 1 to a forwarded telephone number corresponding to a TDM EI for Party B at location 2. In this scenario, the call forwarding is conducted within the ISUP network.

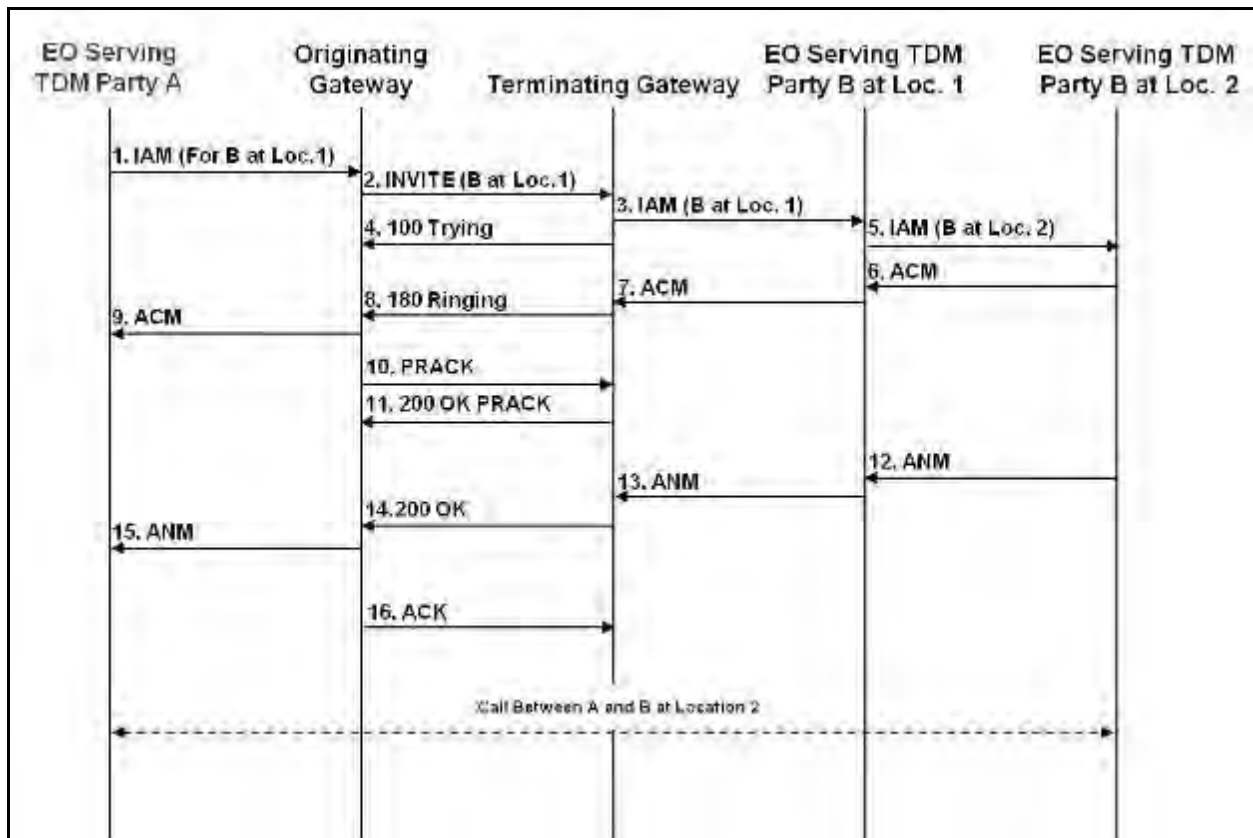

**Figure 16.5-1. TDM Bridging Call Forward Unconditional
(Call Forward Signaling Occurs Within ISUP Network)**

Call Forward

STEP	INSTRUCTION
1	The EO serving TDM Party A sends an IAM (intended for TDM Party B at location 1) to the originating gateway.
2	The originating gateway creates an INVITE request and sends the INVITE request to the terminating gateway providing connectivity to the EO serving TDM Party B at location 1.
3	The terminating gateway receives the INVITE request, creates an IAM, translates the fields of the INVITE request to those of the IAM, and sends the IAM to the EO serving TDM Party B at location 1.
4	The terminating gateway sends a 100 (Trying) response to the originating gateway.

STEP	INSTRUCTION
5	The EO serving TDM Party B at location 1 has been notified by User B to forward all calls to another number (i.e., TDM EI for Party B at location 2). Upon receiving the IAM from the terminating gateway intended for TDM Party B at location 1, the EO modifies the IAM to reflect the call forward (e.g., adds the “OCN” parameter and the “Redirection Information” parameter, which includes the Original Redirection Reason set to “0011” (Unconditional call forward), the Redirect counter) and sends the IAM on the SS7 network to the EO serving TDM Party B at location 2.
6	The EO serving TDM Party B at location 2 initiates the ringing tone on the TDM EI at location 2 and sends an ACM to the EO serving TDM Party B at location 1. The Notification Indicators field in the ACM is set to “1111011” (call is forwarded or deflected). The Called Party’s Status Indicator of the BCIs is set to “01” (Subscriber free).
7	The EO serving TDM Party B at location 1 forwards the ACM to the terminating gateway.
8	The terminating gateway creates a 180 (Ringing) response, and sends the 180 (Ringing) response to the originating gateway.
9	The originating gateway receives the 180 Ringing response, creates an ACM, and sends the ACM to the EO serving TDM Party A.
10	The originating gateway sends a PRACK to the terminating gateway.
11	The terminating gateway sends a 200 (OK) PRACK to the originating gateway.
12	The EO serving TDM Party B at location 2 sends an ANM to the EO serving TDM Party B at location 1.
13	The EO serving TDM Party B at location 1 forwards the ANM to the terminating gateway.
14	The terminating gateway creates a 200 (OK) response and sends the 200 (OK) response to the originating gateway.
15	The originating gateway receives the 200 (OK) response, creates an ANM, and sends the ANM to the EO serving TDM Party A.
16	The originating gateway sends an ACK to the terminating gateway.

The forwarded call is established now between TDM Party A and TDM Party B at location 2.

16.5.1.3 TDM-to-IP Call Type

SIP-010530 [Figure 16.5-2](#), TDM-to-IP Call Forwarding, depicts the sequence of AS-SIP and ISUP messages between the EO serving TDM Party A, the SC serving IP Party B at location 1 (which unconditionally forwards call requests intended for IP Party B at location 1 to IP Party B at location 2), and the SC serving IP Party B at location 2.

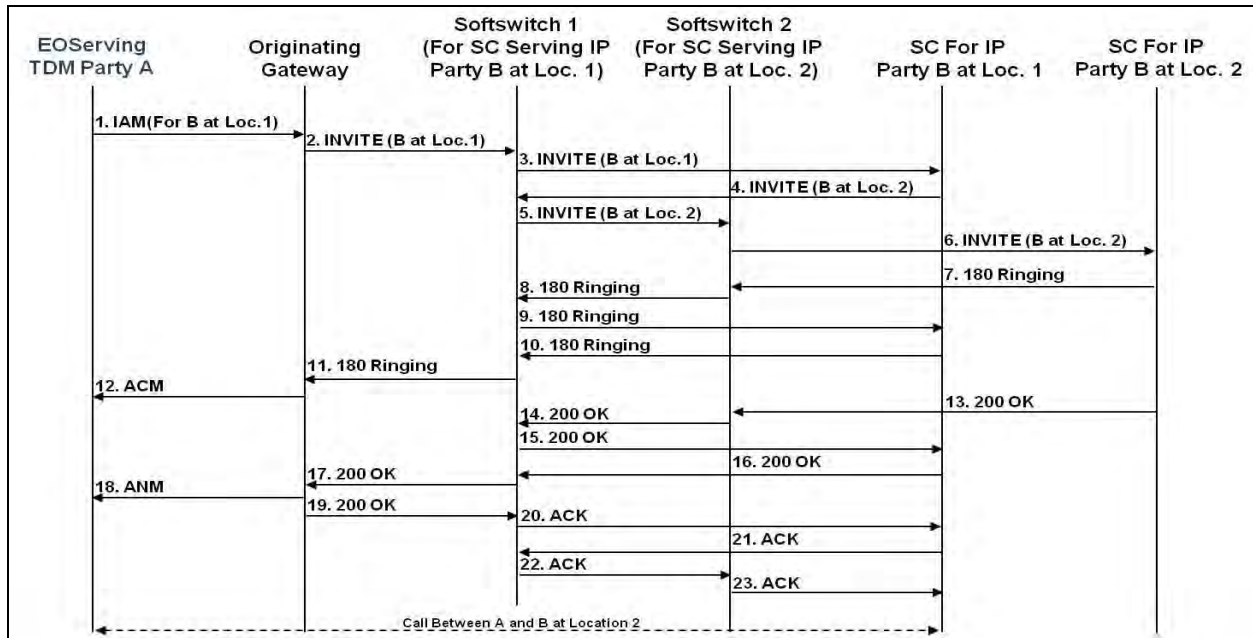

Figure 16.5-2. TDM-to-IP Call Forwarding

NOTE: For IP EIs directly served by a given SC, said SC is the signaling platform that will be apprised of the call forwarding preference of the user. This being the case, and given that we are adopting the approach described in draft-ietf-sipping-service-examples, which implements call forward by rewriting the Request-URI field (as opposed to conducting a redirect), the SC serving IP Party B at location 1 will stay in the call path for the SIP signaling. This means SIP signaling messages will be routed from the SS responsible for the SC serving IP Party B at location 1 to the SC serving IP Party B at location 1, and then return to the SS for routing toward the SC serving IP Party B at location 2.

NOTE: To simplify the call flow diagram, the 100 (Trying) responses have been omitted.

Call Forward

STEP	INSTRUCTION
1	The EO serving TDM Party A sends an IAM (intended for IP Party B at location 1) to the originating gateway.
2	The originating gateway creates an INVITE and sends the INVITE to SS 1 (which is responsible for the SC serving IP Party B at location 1).
3	SS 1 forwards the INVITE to the SC serving IP Party B at location 1.
4	The SC serving IP Party B at location 1 has previously been notified to unconditionally forward call requests intended for the IP EI associated with Party B at location 1 to the SIP URI for IP Party B at location 2.
	The SC serving IP Party B at location 1 rewrites the Request URI and sends the INVITE back to SS 1 for forwarding to IP Party B at location 2.

STEP	INSTRUCTION
5	SS 1 sends the INVITE to SS 2 (which is responsible for the SC serving IP Party B at location 2).
6	SS 2 sends the INVITE to the SC serving IP Party B at location 2.
	NOTE: Signaling is not depicted between the SC serving IP Party B at location 2 and the IP EI at location 2.
7, 8, 9, 10, 11	The SC serving IP Party B at location 2 sends a 180 (Ringing) response to SS 2. SS 2 forwards the 180 (Ringing) response to SS 1. SS 1 forwards the 180 (Ringing) response to the SC serving IP Party B at location 1.
	The SC serving IP Party B at location 1 forwards the 180 (Ringing) response back to SS 1.
	SS 1 forwards the 180 (Ringing) response to the originating gateway.
	NOTE: Signaling is not depicted between the IP EI serving IP Party B at location 2 and the SC serving IP Party B at location 2.
12	The originating gateway receives the 180 (Ringing) response and creates an ACM which it sends to the EO serving TDM Party A.
13, 14, 15, 16, 17	The SC serving IP Party B at location 2 sends a 200 (OK) response to SS 2. SS 2 forwards the 200 (OK) response to SS 1. SS 1 forwards the 200 (OK) response to the SC serving IP Party B at location 1.
	The SC serving IP Party B at location 1 forwards the 200 (OK) response back to SS 1.
	SS 1 forwards the 200 (OK) response to the originating gateway.
	NOTE: Signaling is not depicted between the IP EI serving IP Party B at location 2 and the SC serving IP Party B at location 2.
18	The originating gateway receives the 200 (OK) response and creates an ANM, which it sends to the EO serving TDM Party A.
19, 20, 21, 22, 23	The originating gateway sends an ACK to SS 1.
	SS 1 forwards the ACK to the SC serving IP Party B at location 1. The SC serving IP Party B at location 1 forwards the ACK back to SS 1. SS 1 forwards the ACK to SS 2. SS 2 forwards the ACK to the SC serving IP Party B at location 2.
	NOTE: Signaling is not depicted between the SC serving IP Party B at location 2 and the IP EI at location 2.

16.5.1.4 IP-to-TDM Call Type

SIP-010540 [Figure 16.5-3](#), IP-to-TDM Call Forwarding, depicts the sequence of AS-SIP and ISUP messages between the SC serving IP Party A, the EO serving TDM Party B at location 1, and the EO serving TDM Party B at location 2 that are involved in the unconditional forwarding of a call request intended for TDM Party B at location 1 to a forwarded telephone number corresponding to a TDM EI for Party B at location 2. In this scenario, the call forwarding occurs in the ISUP network.

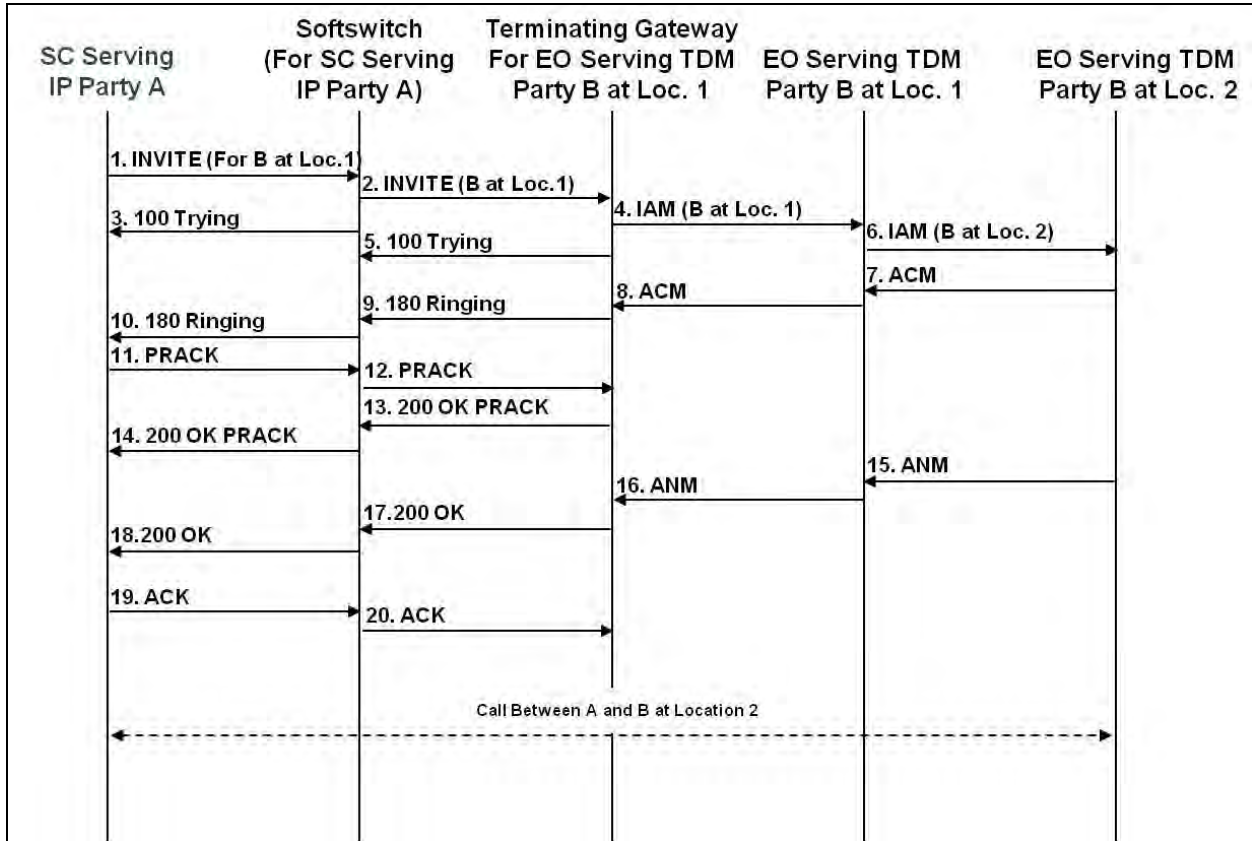

Figure 16.5-3. IP-to-TDM Call Forwarding (Call Forward Signaling Occurs in ISUP Network)

Call Forward

STEP	INSTRUCTION
1	The SC serving IP Party A sends an INVITE to its assigned SS.
	NOTE: Signaling is not depicted between the IP EI serving IP Party A and the SC serving IP Party A.
2	The SS forwards the INVITE to the terminating gateway.
3	The SS sends a 100 (Trying) response code to the SC serving IP Party A.
4	The terminating gateway sends an IAM to the EO serving TDM Party B at location 1.
5	The terminating gateway sends a 100 (Trying) response code to the SS.
6	The EO serving TDM Party B at location 1 has been notified by User B to forward all calls to another number (i.e., TDM EI for Party B at location 2). Upon receiving the IAM from the terminating gateway intended for TDM Party B at location 1, the EO modifies the IAM to reflect the call forward (e.g., adds the “OCN” parameter and the “Redirection Information” parameter, which includes the Original Redirection Reason set to “0011” (Unconditional call forward), the Redirect counter, etc.) and sends the IAM on the SS7 network to the EO serving TDM Party B at location 2.
7	The EO serving TDM Party B at location 2 initiates ringing of the TDM EI at location 2 and sends an ACM to the EO serving TDM Party B at location 1. The Notification Indicators field in the ACM is set to “1111011” (call is forwarded/deflected). The Called Party’s Status Indicator of the BCI is set to “01” (Subscriber free).

STEP	INSTRUCTION
8	The EO serving TDM Party B at location 1 forwards the ACM to the terminating gateway.
9, 10	The terminating gateway receives the ACM, creates a 180 (Ringing) response, and sends the 180 (Ringing) response to the SS, which, in turn, forwards the 180 (Ringing) response to the SC serving IP Party A.
	NOTE: Signaling is not depicted between the SC serving IP Party A and the IP EI serving IP Party A.
11, 12	The SC serving IP Party A sends a PRACK to the SS, which forwards the PRACK to the terminating gateway.
13, 14	The terminating gateway sends a 200 (OK) response to the SS, which forwards the 200 (OK) response to the SC serving IP Party A.
15	The EO serving TDM Party B at location 2 sends an ANM to the EO serving TDM Party B at location 1.
16	The EO serving TDM Party B at location 1 forwards the ANM to the terminating gateway.
17, 18	The terminating gateway receives the ANM, creates a 200 (OK) response, and sends the 200 (OK) response to the SS, which forwards the 200 (OK) response to the SC serving IP Party A.
	NOTE: Signaling is not depicted between the SC serving IP Party A and the IP EI serving IP Party A.
19, 20	The SC serving IP Party A sends an ACK to the SS, which forwards the ACK to the terminating gateway.
	NOTE: Signaling is not depicted between the IP EI serving IP Party A and the SC serving IP Party A.

The forwarded call is established now between IP Party A and TDM Party B at location 2.

16.5.2 Call Forward (No Answer)

A user instructs that call requests to a particular telephone number be routed to a different predefined telephone number if the call is not answered within some number of rings (No Answer). In the following call flow diagrams, User B has instructed that call requests addressed to User B's telephone number at location 1, which receive no reply, be rerouted to a different telephone number for an EI at location 2.

16.5.2.1 IP-to-IP Call Type

SIP-010550 See [Section 9.5.2.1](#), IP-to-IP Call Type.

16.5.2.2 TDM Bridging Call Type

SIP-010560 [Figure 16.5-4](#), TDM Bridging Call Forwarding on No Answer, depicts the sequence of AS-SIP and ISUP messages involved in the forwarding of an unanswered call request for TDM Party B at location 1 to a forwarded telephone number corresponding to a TDM EI for Party B at location 2.

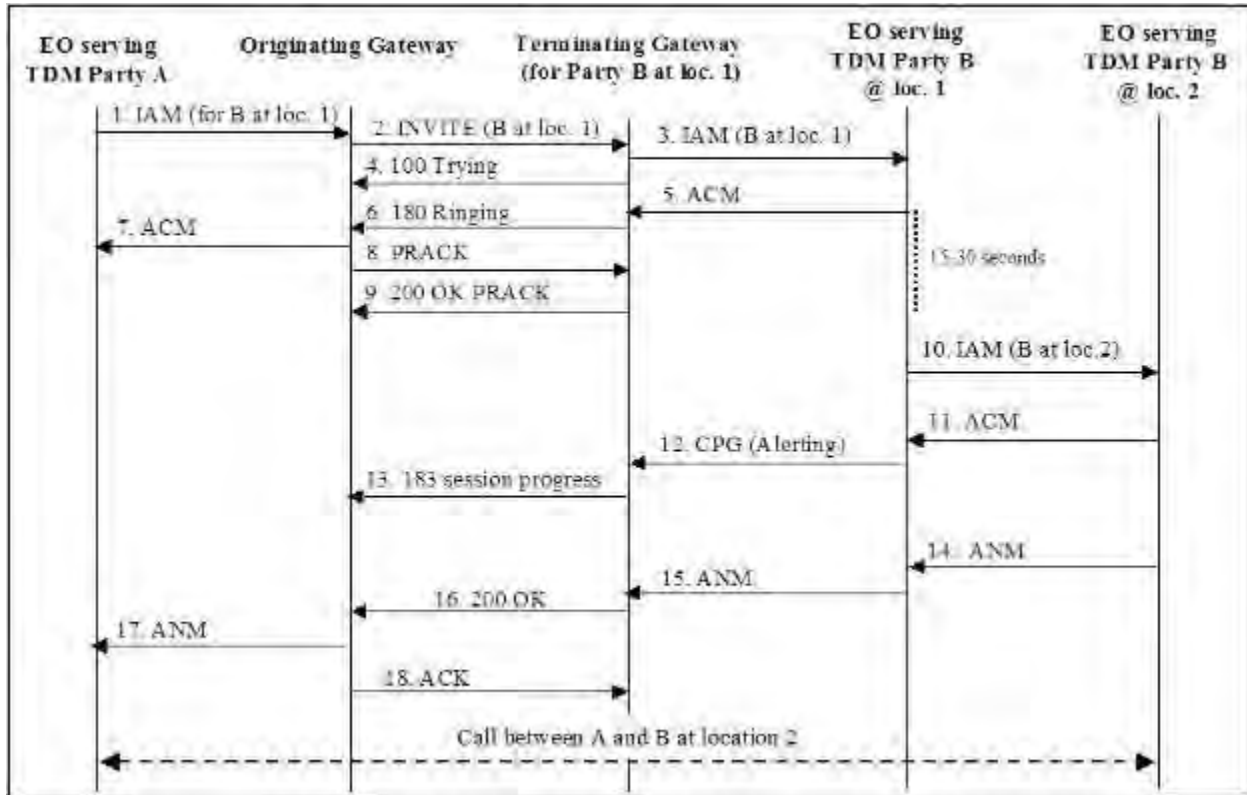

Figure 16.5-4. TDM Bridging Call Forwarding on No Answer

Call Forward

STEP	INSTRUCTION
1	The EO serving TDM Party A sends an IAM (intended for TDM Party B at location 1) to the originating gateway.
2	The originating gateway creates an INVITE request and sends the INVITE request to the terminating gateway providing connectivity to the EO serving TDM Party B at location 1.
3	The terminating gateway receives the INVITE request, creates an IAM (using the information in the INVITE request), and sends the IAM to the EO serving TDM Party B at location 1.
4	The terminating gateway sends a 100 (Trying) response to the originating gateway.
5	The EO serving TDM Party B at location 1 has been notified by User B if there is no reply to the call, the call request is to be forwarded to another number (located at a different EO).
	Upon receiving the IAM from the terminating gateway, the EO initiates a ringing tone at the TDM EI and sends an ACM to the terminating gateway while waiting between 15 to 30 seconds for Party B to go off-hook. The Called Party's Status Indicator of the BCIs is set to "01" (Subscriber free). The Optional "BCIs" parameter is present and the Call Forwarding MAY Occur Indicator of the Optional "BCIs" parameter is set to "1" (Call forwarding may occur).
6	The terminating gateway receives the ACM, creates a 180 (Ringing) response, and sends the 180 (Ringing) response to the originating gateway.
7	The originating gateway translates the 180 (Ringing) response to an ACM and sends the ACM to the EO serving TDM Party A.

STEP	INSTRUCTION
8	The originating gateway sends a PRACK to the terminating gateway.
9	The terminating gateway sends a 200 (OK) PRACK to the originating gateway.
10	Upon no reply, the EO serving TDM Party B at location 1 modifies the IAM to reflect the call forward (e.g., adds the “OCN” parameter and the “Redirection Information” parameter, which includes the Original Redirection Reason set to “0010” (No reply), the Redirection counter) and sends the IAM on the SS7 network to the EO serving TDM Party B at location 2.
11	The EO serving TDM Party B at location 2 initiates the ringing of the EI at location 2 and sends an ACM to the EO serving TDM Party B at location 1. The Notification Indicators field in the ACM is set to “1111011” (call is forwarded/deflected). The Called Party’s Status Indicator of the BCIs is set to “01” (Subscriber free).
12	The EO serving TDM Party B at location 1 receives the ACM and creates a CPG with the event code set to 1 (Alerting), which it sends to the terminating gateway.
13	The terminating gateway creates a 183 (Session Progress) response and sends the 183 (Session Progress) response to the originating gateway.
14	The EO serving TDM Party B at location 2 sends an ANM to the EO serving TDM Party B at location 1.
15	The EO serving TDM Party B at location 1 forwards the ANM to the terminating gateway.
16	The terminating gateway receives the ANM, creates a 200 (OK) response, and sends the 200 (OK) response to the originating gateway.
17	The originating gateway receives the 200 (OK) response, creates an ANM, and sends the ANM to the EO serving TDM Party A.
18	The originating gateway sends an ACK to the terminating gateway.

The forwarded call is established now between TDM Party A and TDM Party B at location 2.

16.5.2.3 TDM-to-IP Call Type

SIP-010570 [Figure 16.5-5](#), TDM-to-IP Call Forwarding on No Answer, depicts the sequence of AS-SIP and ISUP messages involved in forwarding an unanswered call request for IP Party B at location 1 to a forwarded telephone number (SIP URI) corresponding to an IP EI for Party B at location 2. In the present scenario, the SC serving IP Party B at location 1 has been notified previously that upon a “no answer,” the SC is to forward calls to IP Party B at location 2.

NOTE: To simplify the call flow diagram the 100 (Trying) responses have been omitted.

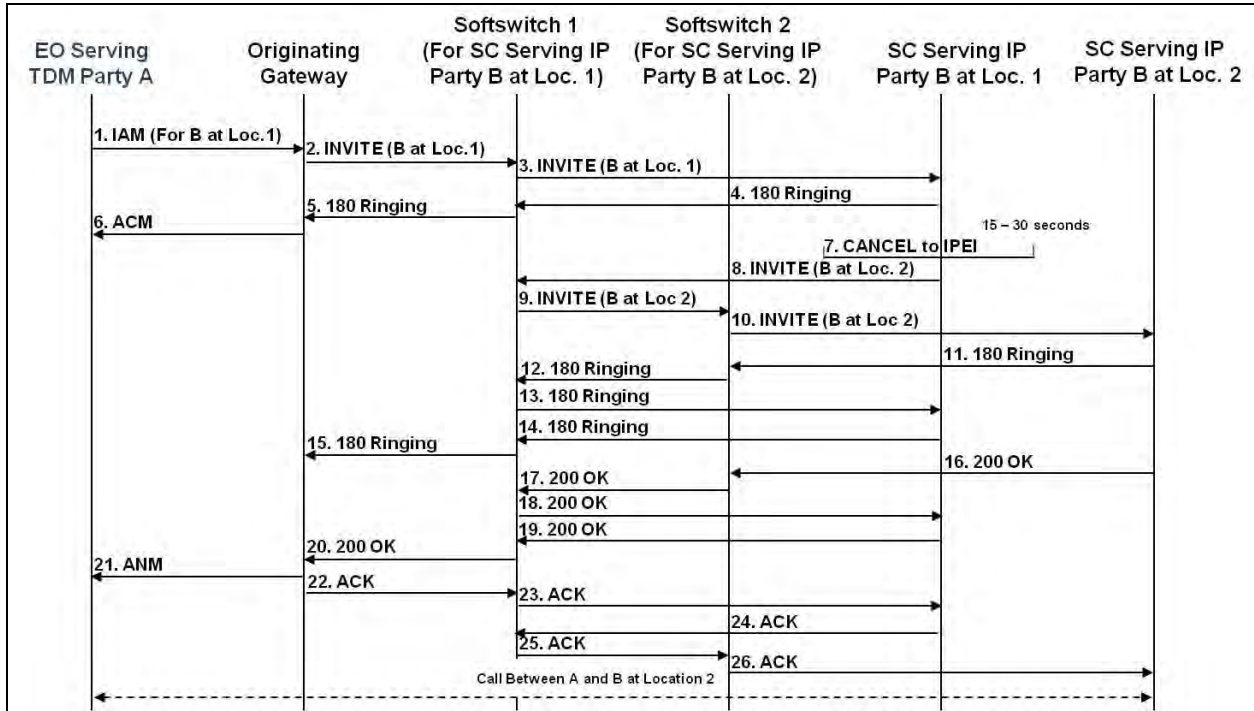

Figure 16.5-5. TDM-to-IP Call Forwarding on No Answer

Call Forward

STEP	INSTRUCTION
1	The EO serving TDM Party A sends an IAM (intended for TDM Party B at location 1) to the originating gateway.
2	The originating gateway creates an INVITE request, and sends the INVITE request to SS 1 (which is responsible for the SC serving IP Party B at location 1).
3	SS 1 forwards the INVITE request to the SC serving IP Party B at location 1.
	NOTE: Signaling is not depicted between the SC serving IP Party B at location 1 and the IP EI serving IP Party B at location 1.
4, 5	The SC serving IP Party B at location 1 sends a 180 (Ringing) response to SS 1, which forwards the 180 (Ringing) response to the originating gateway.
	NOTE: User B has instructed the SC previously that if there is no reply to the call within a predefined period, the call request is to be forwarded to another number (SIP URI) corresponding to an IP EI at location 2.
	NOTE: Signaling is not depicted between the IP EI serving IP Party B at location 1 and the SC serving IP Party B at location 1.
6	The originating gateway receives the 180 (Ringing) response and sends an ACM to the EO serving the TDM EI.
7	If there is no answer within the predefined time interval (e.g., 15 to 30 seconds), then the SC serving IP Party B at location 1 cancels the call request with the IP EI for Party B at location 1.
	NOTE: In the case of a SIP EI, the SC sends a CANCEL request, the SIP EI sends a 200 (OK) response to the CANCEL and a 487 (Request Terminated) response to the INVITE request, and the SC responds with an ACK to the 487 (Request Terminated) response.

STEP	INSTRUCTION
8	The SC serving IP Party B at location 1 rewrites the Request-URI to reflect that the call is now intended for IP Party B at location 2 and sends the INVITE to SS 1.
9, 10	SS 1 sends the INVITE request to SS 2 (which is responsible for the SC serving IP Party B at location 2) and SS 2 sends the INVITE request to the SC serving IP Party B at location 2.
	NOTE: Signaling is not depicted between the SC serving IP Party B at location 2 and the IP EI for Party B at location 2.
11, 12, 13, 14, 15	The SC serving IP Party B at location 2 sends a 180 (Ringing) response to SS 2. SS 2 sends the 180 (Ringing) response to SS 1. SS 1 sends the 180 (Ringing) response to the SC serving IP Party B at location 1. The SC serving IP Party B at location 1 sends the 180 (Ringing) response back to SS 1. SS 1 sends the 180 (Ringing) response to the originating gateway.
	NOTE: Signaling is not depicted between the IP EI for Party B at location 2 to the SC serving IP Party B at location 2.
16, 17, 18, 19, 20	The SC serving IP Party B at location 2 sends a 200 (OK) response to SS 2. SS 2 sends the 200 (OK) response to SS 1. SS 1 sends the 200 (OK) response to the SC serving IP Party B at location 1. The SC serving IP Party B at location 1 sends the 200 (OK) response back to SS 1. SS 1 sends the 200 (OK) response to the originating gateway.
	NOTE: Signaling is not depicted between the IP EI for Party B at location 2 to the SC serving IP Party B at location 2.
21	The originating gateway sends an ANM to the EO serving TDM Party.
22, 23, 24, 25, 26	The originating gateway sends an ACK to SS 1. SS 1 sends the ACK to the SC serving IP Party B at location 1. The SC serving IP Party B at location 1 sends the ACK back to SS 1. SS 1 sends the ACK to SS 2. SS 2 sends the ACK to the SC serving IP Party B at location 2.
	NOTE: Signaling is not depicted between the SC serving IP Party B at location 2 and the IP EI serving Party B at location 2.

The forwarded call is established now between TDM Party A and IP Party B at location 2.

16.5.2.4 IP-to-TDM Call Type

SIP-010580 [Figure 16.5-6](#), IP-to-TDM Call Forwarding (No Answer), depicts the sequence of AS-SIP and ISUP messages involved in forwarding an unanswered call request for TDM Party B at location 1 to a forwarded phone number corresponding to a TDM EI for Party B at location 2.

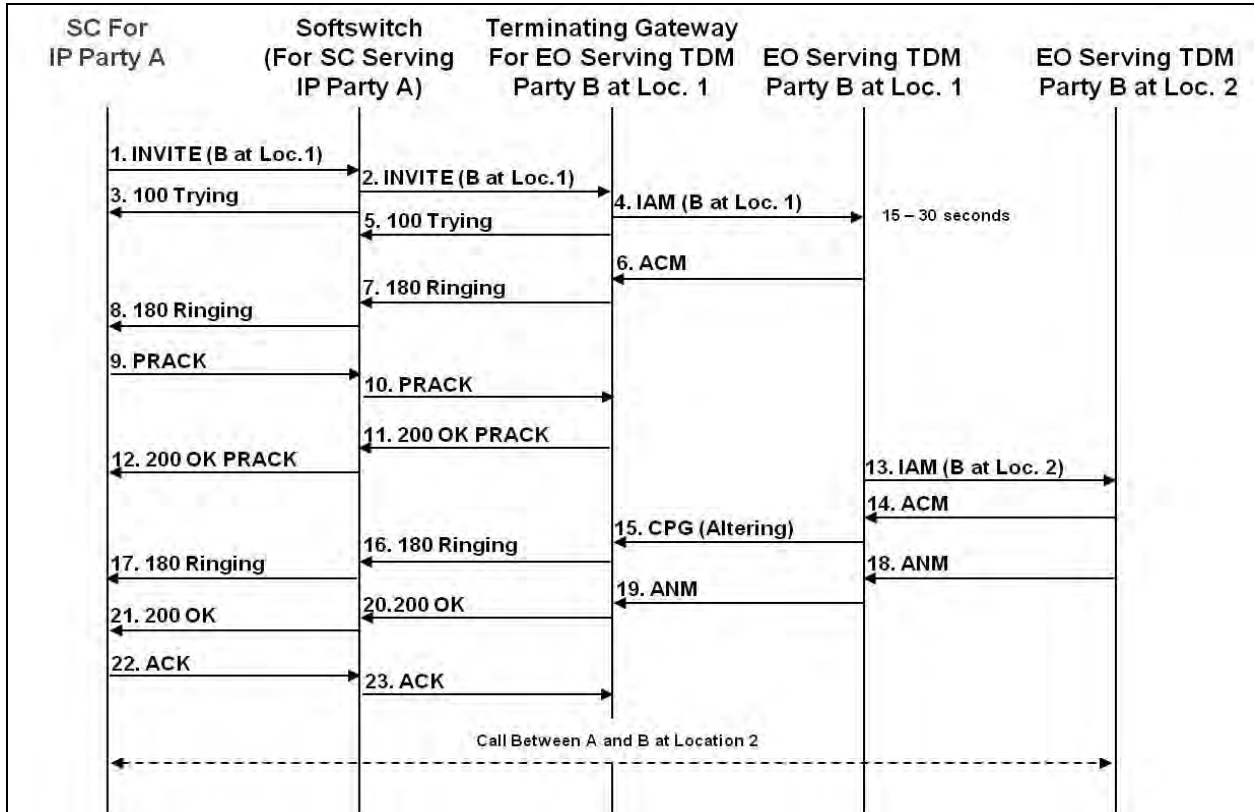

Figure 16.5-6. IP-to-TDM Call Forwarding (No Answer)

Call Forward

STEP	INSTRUCTION
1	The SC serving IP Party A sends an INVITE request to its assigned SS.
	NOTE: Signaling is not depicted between the IP EI serving IP Party A and the SC serving IP Party A.
2	The SS sends the INVITE request to the terminating gateway providing connectivity to the EO serving TDM Party B at location 1.
3	The SS sends a 100 (Trying) response to the SC serving IP Party A.
4	The terminating gateway creates an IAM that it sends to the EO serving TDM Party B at location 1.
5	The terminating gateway sends a 100 (Trying) response to the originating gateway.
6	The EO serving TDM Party B at location 1 has been notified by User B that if there is “no reply,” the call is to be forwarded to another number (located at a different EO).
	Upon receiving the IAM from the terminating gateway intended for TDM Party B at location 1, the EO initiates ringing of the EI at location 1 and sends an ACM to the terminating gateway while waiting between 15 to 30 seconds for Party B to go off-hook. The Called Party’s Status Indicator of the BCI is set to “01” (Subscriber free). The Optional “BCI” parameter is present and the Call Forwarding MAY Occur Indicator of the Optional “BCI” parameter is set to “1” (Call forwarding may occur).
7, 8	The terminating gateway receives the ACM, creates a 180 (Ringing) response, and sends the 180 (Ringing) response to the SS. The SS forwards the 180 (Ringing) response to the SC serving IP Party A.

STEP	INSTRUCTION
	NOTE: Signaling is not depicted between the SC serving IP Party A and the IP EI serving IP Party A.
9, 10	The SC serving IP Party A sends a PRACK to the SS, which forwards the PRACK to the terminating gateway.
11, 12	The terminating gateway sends a 200 (OK) PRACK to the SS, which forwards the 200 (OK) PRACK to the SC serving IP Party A.
13	Upon no reply, the EO serving TDM Party B at location 1 modifies the IAM to reflect the call forward (e.g., adds the “OCN” parameter and the Redirection Information” parameter, which includes the Original Redirection Reason set to “0010” (No reply), the Redirection counter) and sends the IAM on the CCS7 network to the EO serving TDM Party B at location 2.
14	The EO serving TDM Party B at location 2 creates an ACM, which it sends to the EO serving TDM Party B at location 1.
15	The EO serving TDM Party B at location 1 receives the ACM and creates a CPG with the event code set to 1 (Alerting), which it sends to the terminating gateway.
16, 17	The terminating gateway creates a 180 (Ringing) response and sends the 180 (Ringing) response to the SS. The SS forwards the 180 (Ringing) response to the SC serving IP Party A.
	NOTE: Signaling is not depicted between the SC serving IP Party A and the IP EI serving IP Party A.
18	The EO serving TDM Party B at location 2 sends an ANM to the EO serving TDM Party B at location 1.
19	The EO serving TDM Party B at location 1 forwards the ANM to the terminating gateway.
20, 21	The terminating gateway receives the ANM, creates a 200 (OK) response, and sends the 200 (OK) response to the SS. The SS forwards the 200 (OK) response to the SC serving IP Party A.
	NOTE: Signaling is not depicted between the SC serving IP Party A and the IP EI serving IP Party A.
22, 23	The SC serving IP Party A sends an ACK to the SS, which forwards the ACK to the terminating gateway.
	NOTE: Signaling is not depicted between the IP EI and the SC serving IP Party A.

The forwarded call is established now between IP Party A and TDM Party B at location 2.

16.5.3 Call Forward (Busy)

A user instructs that call requests to a particular telephone number be routed to a different predefined telephone number if the EI is busy with another call. In the following call flow diagrams, User B has instructed that when a call request is addressed to User B’s telephone at location 1 but the telephone is currently busy with another call, then the new call request is to be forwarded to an EI at location 2.

Recalling AS-SIP requirement from Requirement SIP-004960, the new call request will be forwarded only if the existing call has either an equal or higher precedence level than the incoming call request. If the existing call has a lower precedence than the incoming call request, then the existing call will be preempted in favor of the new call request.

16.5.3.1 IP-to-IP Call Type

SIP-010590 See [Section 9.5.3.1](#), IP-to-IP Call Type.

16.5.3.2 TDM Bridging Call Type

SIP-010600 [Figure 16.5-7](#), TDM Bridging Call Forwarding on Busy, depicts the sequence of AS-SIP and ISUP messages involved in forwarding of a call request intended for TDM Party B at location 1 however the EI for TDM Party B at location 1 is currently busy with a call of equal or higher precedence than the incoming call request so the call request is forwarded to TDM Party B at location 2. In this scenario, the call forwarding occurs within the SS7 network.

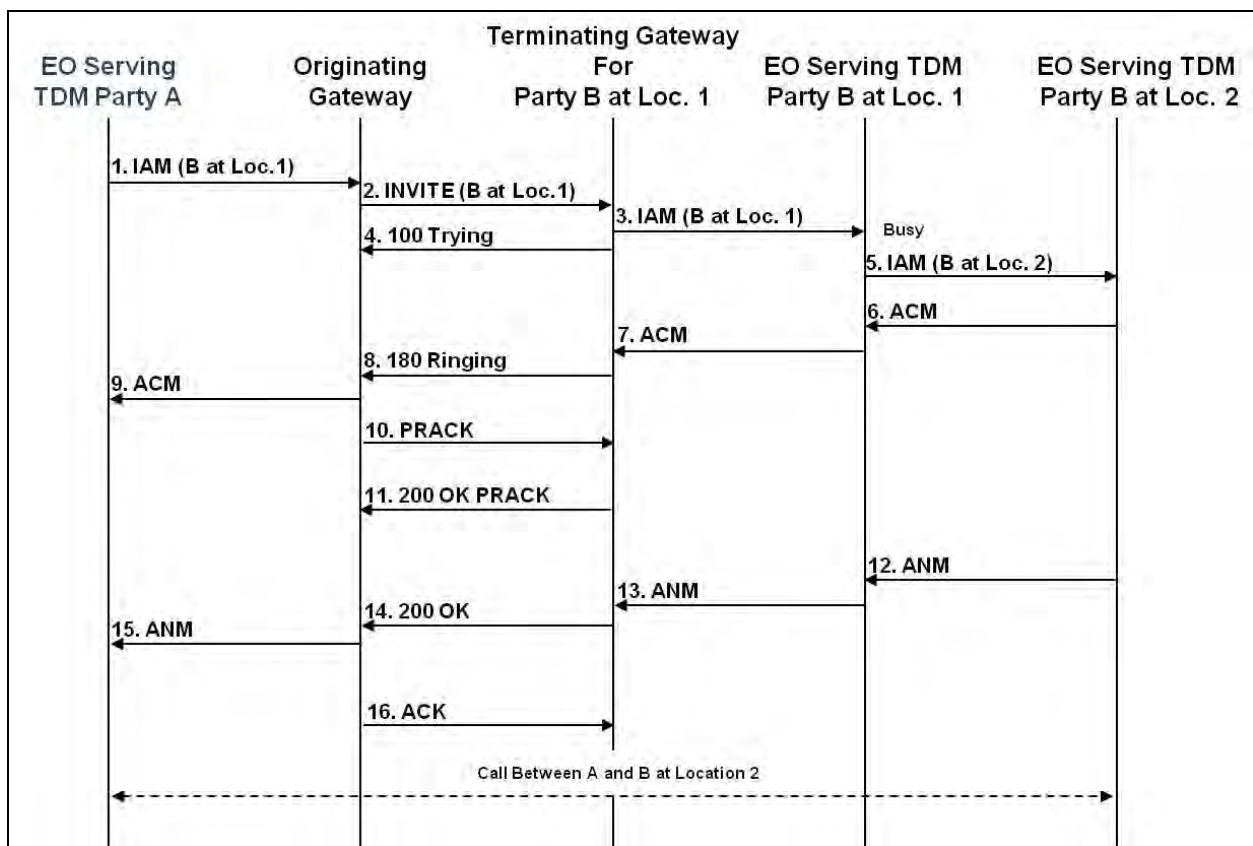

**Figure 16.5-7. TDM Bridging Call Forwarding on Busy
(Call Forward Signaling Occurs Within ISUP Network)**

Call Forward

STEP	INSTRUCTION
1	The EO serving TDM Party A sends an IAM (intended for TDM Party B at location 1) to the originating gateway.

STEP	INSTRUCTION
2	The originating gateway creates an INVITE request, and sends the INVITE request to the terminating gateway providing connectivity to the EO serving TDM Party B at location 1.
3	The terminating gateway receives the INVITE request, creates an IAM (using the information found in the INVITE request), and sends the IAM to the EO serving TDM Party B at location 1.
4	The terminating gateway sends a 100 (Trying) response to the originating gateway.
5	The EO serving TDM Party B at location 1 has been notified by User B that in the event the EI is busy (with a call of equal or higher precedence than the new call request), the new call request is to be forwarded to another number (located at a different EO).
	Since in this case the TDM EI is busy with a call of equal or higher precedence, the EO serving TDM Party B at location 1 modifies the IAM to forward the call (e.g., adds the "OCN" parameter and the "Redirection Information" parameter, which includes the Original Redirection Reason set to "0001" (User Busy), the Redirection counter, etc.) and sends the IAM on the SS7 network to the EO serving TDM Party B at location 2.
6	The EO serving TDM Party B at location 2 initiates ringing the TDM Party B location 2 EI and sends an ACM to the EO serving TDM Party B at location 1. The Notification Indicators field in the ACM is set to "1111011" (call is forwarded/deflected). The Called Party's Status Indicator of the BCIs is set to "01" (Subscriber free).
7	The EO serving TDM Party B at location 1 sends the ACM to the terminating gateway.
8	The terminating gateway creates a 180 (Ringing) response, and sends the 180 (Ringing) response to the originating gateway.
9	The originating gateway receives the 180 (Ringing) response, creates an ACM, and sends the ACM to the EO serving TDM Party A.
10	The originating gateway sends a PRACK to the terminating gateway.
11	The terminating gateway sends a 200 (OK) PRACK.
12	The EO serving TDM Party B at location 2 sends an ANM to the EO serving TDM Party B at location 1.
13	The EO serving TDM Party B at location 1 forwards the ANM to the terminating gateway.
14	The terminating gateway receives the ANM, creates a 200 (OK) response, and sends the 200 (OK) response to the originating gateway.
15	The originating gateway receives the 200 (OK) response, creates an ANM, and sends the ANM to the EO serving TDM Party A.
16	The originating gateway sends an ACK to the terminating gateway.

The forwarded call is established now between TDM Party A and TDM Party B at location 2.

16.5.3.3 TDM-to-IP Call Type

SIP-010610 [Figure 16.5-8](#), TDM-to-IP Call Forwarding on Busy, depicts the sequence of AS-SIP and ISUP messages involved in forwarding a call request for IP Party B at location 1 to a forwarded telephone number (SIP URI) corresponding to an IP EI for Party B at location 2 when the IP EI at location 1 is busy with a call of equal or higher precedence than the new call request. In the present scenario, the SC serving IP Party B at location 1 has been notified

previously that upon a “busy” the SC is to forward calls for IP Party B at location 1 to IP Party B at location 2.

NOTE: To simplify the call flow diagram the 100 (Trying) responses have been omitted.

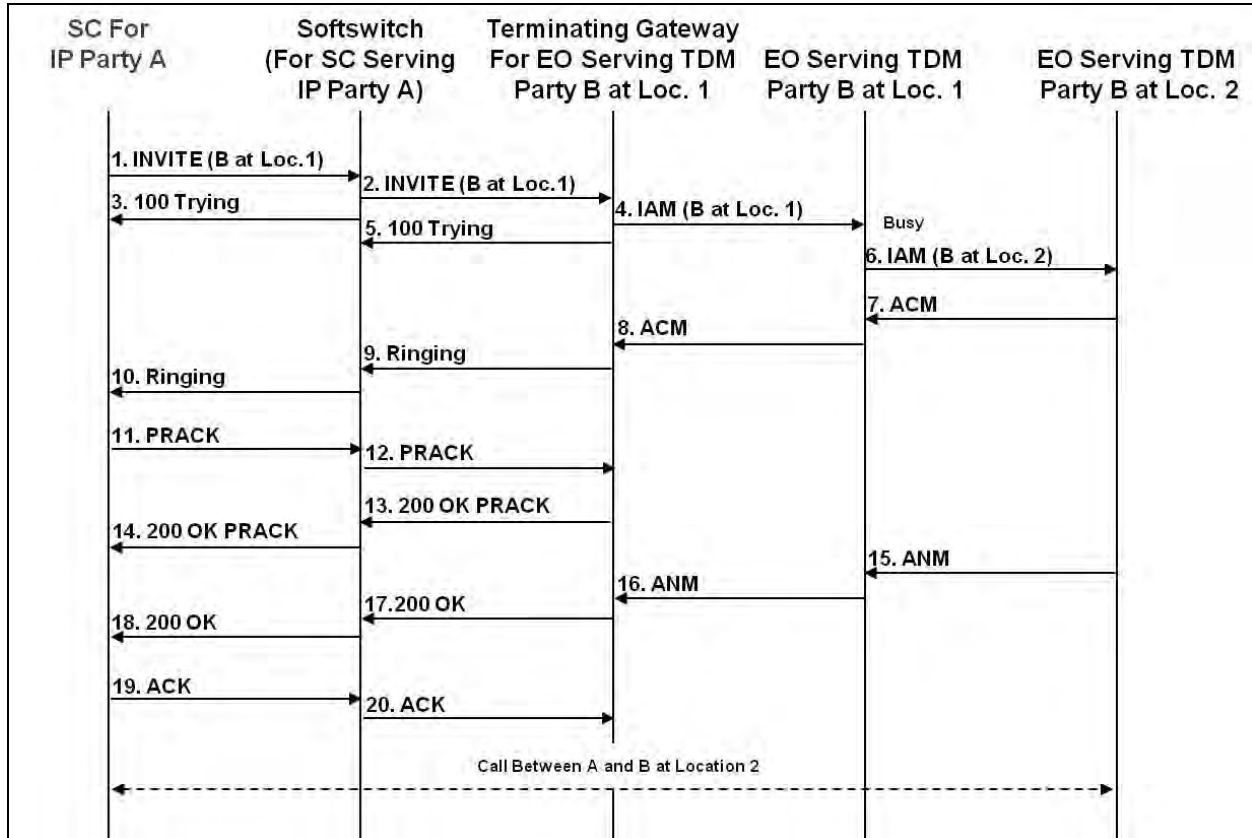

Figure 16.5-8. TDM-to-IP Call Forwarding on Busy

Call Forward

STEP	INSTRUCTION
1	The EO serving TDM Party A sends an IAM (intended for TDM Party B at location 1) to the originating gateway.
2	The originating gateway creates an INVITE request and sends the INVITE request to SS 1, which is responsible for the SC serving IP Party B at location 1.
3	SS 1 forwards the INVITE request to the SC serving IP Party B at location 1.
	NOTE: Signaling is not depicted between the SC serving IP Party B at location 1 and the IP EI serving IP Party B at location 1.
4	The IP EI is busy with a call of equal or higher precedence and rejects the call.
	NOTE: In the case of a SIP EI, the SIP response is a 486 (Busy Here) and the SC responds with an ACK.
5	The SC serving IP Party B at location 1 rewrites the Request-URI to reflect that the call is now intended for IP Party B at location 2 and sends the INVITE request to SS 1.

STEP	INSTRUCTION
6, 7	SS 1 sends the INVITE request to SS 2, which is responsible for the SC serving IP Party B at location 2, and SS 2 sends the INVITE request to the SC serving IP Party B at location 2.
	NOTE: Signaling is not depicted between the SC serving IP Party B at location 2 and the IP EI for Party B at location 2.
8, 9, 10, 11, 12	The SC serving IP Party B at location 2 sends a 180 (Ringing) response to SS 2. SS 2 sends the 180 (Ringing) response to SS 1. SS 1 sends the 180 (Ringing) response to the SC serving IP Party B at location 1. The SC serving IP Party B at location 1 sends the 180 (Ringing) response back to SS 1. SS 1 sends the 180 (Ringing) response to the originating gateway.
	NOTE: Signaling is not depicted between the IP EI for Party B at location 2 to the SC serving IP Party B at location 2.
13	The originating gateway creates an ACM, which it sends to the EO serving TDM Party A.
14, 15, 17, 17, 18	The SC serving IP Party B at location 2 sends a 200 (OK) response to SS 2. SS 2 sends the 200 (OK) response to SS 1. SS 1 sends the 200 (OK) response to the SC serving IP Party B at location 1. The SC serving IP Party B at location 1 sends the 200 (OK) response back to SS 1. SS 1 sends the 200 (OK) response to the originating gateway.
	NOTE: Signaling is not depicted between the IP EI for Party B at location 2 to the SC serving IP Party B at location 2.
19	The originating gateway sends an ANM to the EO serving TDM Party A.
20, 21, 22, 23, 24	The originating gateway sends an ACK to SS 1. SS 1 sends the ACK to the SC serving IP Party B at location 1. The SC serving IP Party B at location 1 sends the ACK back to SS 1. SS 1 sends the ACK to SS 2. SS 2 sends the ACK to the SC serving IP Party B at location 2.
	NOTE: Signaling is not depicted between the SC serving IP Party B at location 2 and the IP EI serving Party B at location 2.

The forwarded call is established now between TDM Party A and IP Party B at location 2.

16.5.3.4 IP-to-TDM Call Type

SIP-010620 [Figure 16.5-9](#), IP-to-TDM Call Forwarding on Busy, depicts the sequence of AS-SIP and ISUP messages involved in forwarding a call request for TDM Party B at location 1 to a forwarded telephone number corresponding to a TDM EI for Party B at location 2 when the IP EI at location 1 is busy with a call of equal or higher precedence than the new call request. In the present scenario, the EO serving TDM Party B at location 1 has been notified previously that upon a “busy” the EO is to forward calls for TDM Party B at location 1 to the EO serving TDM Party B at location 2.

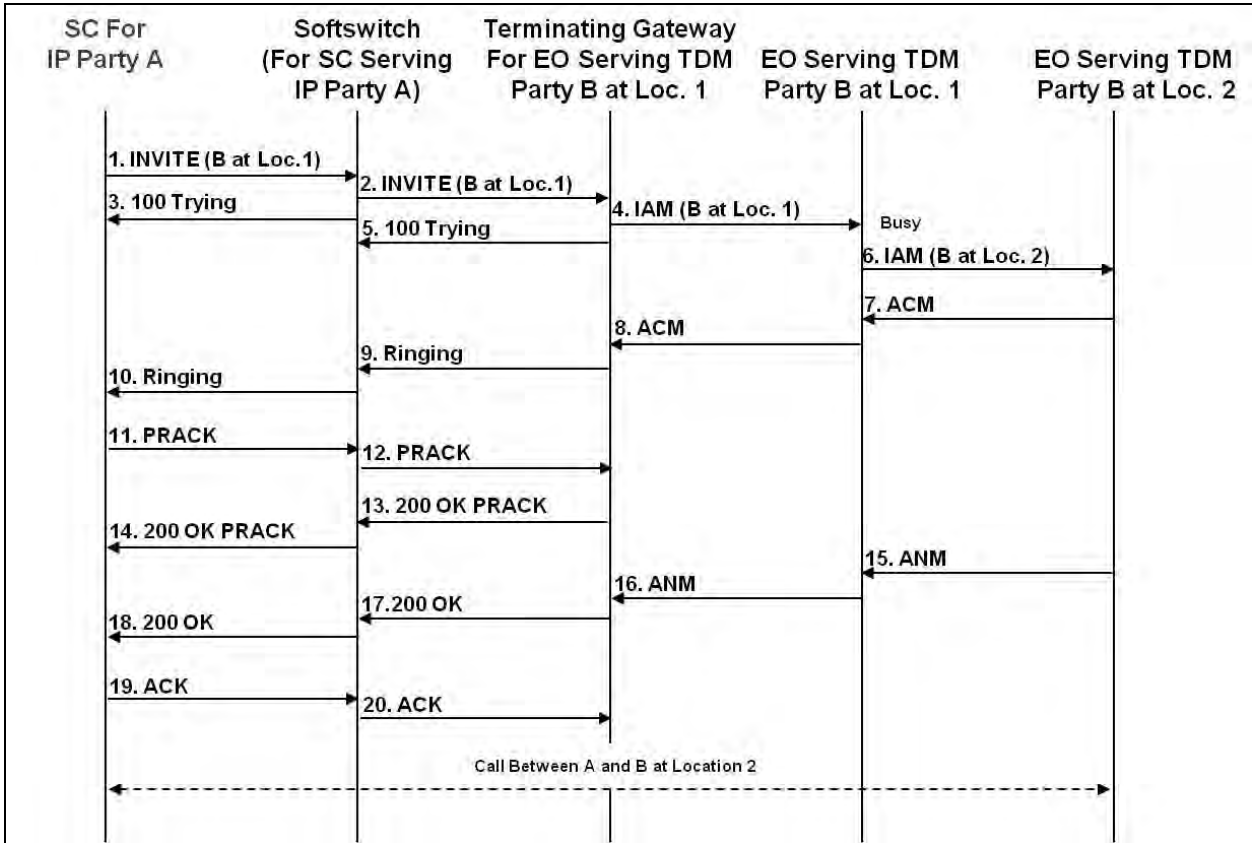

Figure 16.5-9. IP-to-TDM Call Forwarding on Busy

Call Forward

STEP	INSTRUCTION
1	The SC serving IP Party A sends an INVITE request to the SS.
	NOTE: Signaling is not depicted between the IP EI serving IP Party A and the SC serving IP Party A.
2	The SS sends the INVITE request to the terminating gateway providing connectivity to the EO serving TDM Party B at location 1.
3	The SS sends a 100 (Trying) response to the SC serving IP Party A.
4	The terminating gateway creates an IAM that it sends to the EO serving TDM Party B at location 1.
5	The terminating gateway sends a 100 (Trying) response to the SS.
6	The EO serving TDM Party B at location 1 has been notified by User B that if the EI is busy (with a call of equal or higher precedence than the new call request), the new call request is to be forwarded to another number (located at a different EO).
	Since the TDM EI is busy with a call of equal or higher precedence, the EO serving TDM Party B at location 1 modifies the IAM to forward the call (e.g., adds the “OCN” parameter and the “Redirection Information” parameter, which includes the Original Redirection Reason, set to “0001” (User Busy), the Redirection counter) and sends the IAM on the SS7 network to the EO serving TDM Party B at location 2.

STEP	INSTRUCTION
7	The EO serving TDM Party B at location 2 initiates a ringing tone at the TDM EI at location 2 and sends an ACM to the EO serving TDM Party B at location 1. The Notification Indicators field in the ACM is set to “1111011” (call is forwarded/deflected). The Called Party’s Status Indicator of the BCI is set to “01” (Subscriber free).
8	The EO serving TDM Party B at location 1 sends the ACM to the terminating gateway.
9, 10	The terminating gateway creates a 180 (Ringing) response and sends the 180 (Ringing) response to the SS. The SS forwards the 180 (Ringing) response to the SC serving IP Party A.
	NOTE: Signaling is not depicted between the SC serving IP Party A and the IP EI serving IP Party A.
11, 12	The SC serving IP Party A sends a PRACK to the SS, which forwards the PRACK to the terminating gateway.
13, 14	The terminating gateway sends a 200 (OK) response to the SS, which forwards the 200 (OK) response to the SC serving IP Party A.
15, 16	The EO serving TDM Party B at location 2 sends an ANM to the EO serving TDM Party B at location 1.
	The EO serving TDM Party B at location 1 forwards the ANM to the terminating gateway.
17, 18	The terminating gateway receives the ANM, creates a 200 (OK) response, and sends the 200 (OK) response to the SS. The SS forwards the 200 (OK) response to the SC serving IP Party A.
	NOTE: Signaling is not depicted between the SC serving IP Party A and the IP EI serving IP Party A.
19, 20	The SC serving IP Party A sends an ACK to the SS, which forwards the ACK to the terminating gateway.
	NOTE: Signaling is not depicted between the IP EI serving IP Party A and the SC serving IP Party A.

The forwarded call is established now between IP Party A and TDM Party B at location 2.

16.6 CALL TRANSFER

There are three actors in a given TDM transfer event, each playing one of the following roles:

- Transferred Party (or transferee) – the party being transferred to the transfer target.
- Transferring Party (or transferor) – the party initiating the transfer.
- Transfer target – the new party being introduced into a call with the Transferred Party.

NOTE: In a TDM call transfer, the transferor switch stays in the path of the bearer channels between the transferee and the transfer target.

16.6.1 Call Transfer Modes

Call transfer can be operated in two different modes: unattended (blind) and attended (consultation transfer). Blind call transfer will forward the transferee to the new destination without talking to the transfer target. The alternative to this type of call transfer would be consultation transfer, where the call transferor will have a chance to talk to the transfer target before making the transfer.

16.6.2 Unattended Transfer – Call Transferor: TDM

As shown in [Figure 16.6-1](#), Steps 1–15 are the standard SIP and ISUP signaling for establishing a call between the transferee (an AS-SIP signaling appliance serving an IP EI) and the transferor (a TDM switch serving a TDM EI).

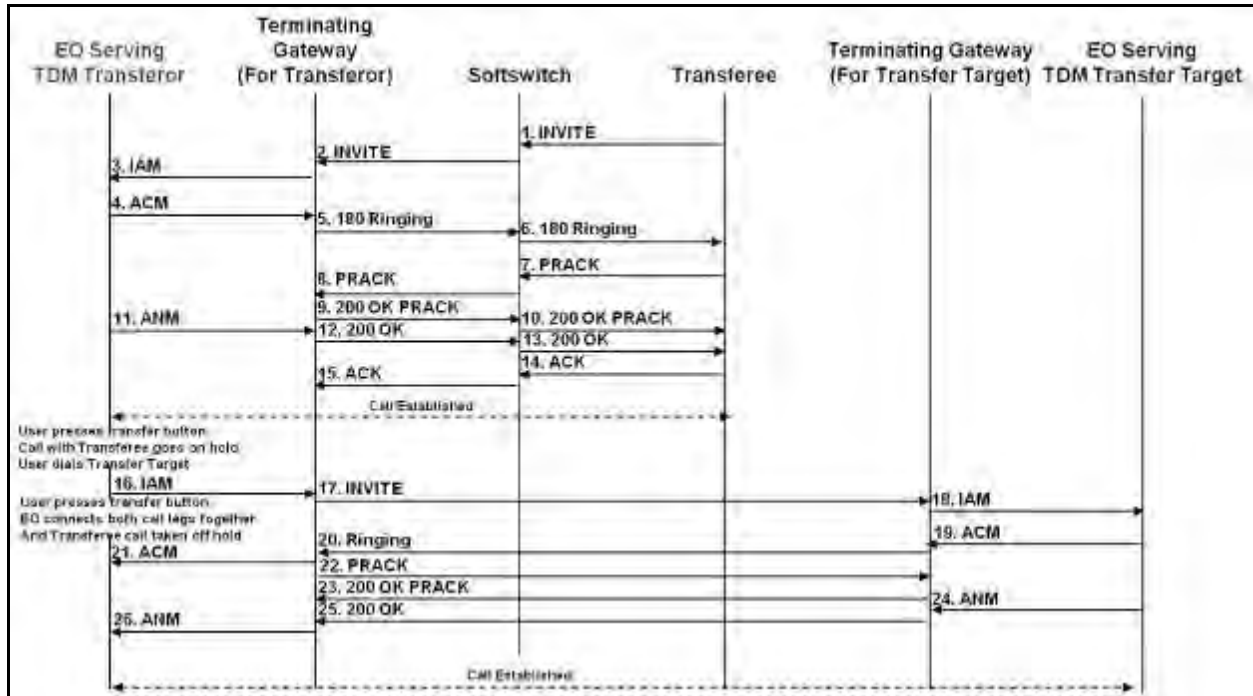

Figure 16.6-1. Unattended Call Transfer (Transferor – TDM)

The call transferor decides to transfer this call to another TDM telephone served by a TDM EO. The transferor user presses the transfer button (or equivalent); thereby signaling the local EO to place the call with the transferee on hold while the transferor user dials the transfer target. Then the transferor initiates a call with the transfer target (Steps 16, 17, 18).

The transferor user again presses the transfer button (or equivalent) and the local EO switch connects the two call legs and takes the transferee off call hold.

Steps 19–26 detail the standard SIP and ISUP signaling for completing the establishment of the call between the transferor switch and transfer target; however, the bearer traffic from the transfer target is being forwarded by the transferor switch to the transferee, and the bearer traffic from the transferee is being forwarded by the transferor switch to the transfer target.

16.6.3 Attended Call Transfer – Call Transferor: TDM

As shown in [Figure 16.6-2](#), the transferor establishes a standard TDM-IP call with the transferee in Steps 1–11.

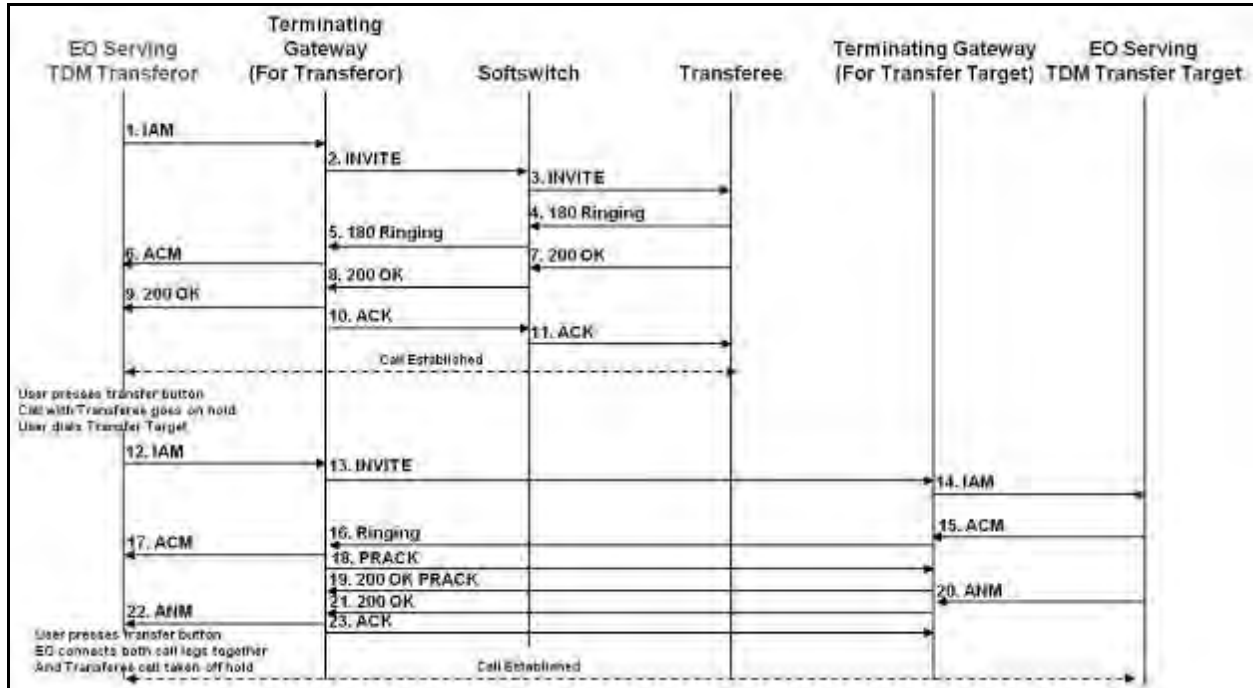

Figure 16.6-2. Attended Call Transfer Transferor – TDM

Then the transferor user presses the transfer button or equivalent, which places the call between the transferor and transferee on hold after which the transferor user dials the transfer target.

The transferor establishes a standard TDM bridging call with the transfer target in Steps 12–23.

The transferor user again presses the transfer button or equivalent, and the local EO switch connects the two call legs and takes the transferee off call hold. At this point, the bearer traffic from the transfer target is being forwarded by the transferor switch to the transferee and the bearer traffic from the transferee is being forwarded by the transferor switch to the transfer target.

SECTION 17 GLOSSARY OF ABBREVIATIONS AND ACRONYMS

ACRONYM	DEFINITION
ABNF	Augmented Backus-Naur Form
ACK	Acknowledgement
ANAT	Alternative Network Address Type
ANSI	American National Standards Institute
APL	Approved Products List
AR	Aggregation Router
AS	Assured Services
ASAC	Assured Services Admission Control
ATQA	Attendant Queue Announcement
AVP	Audio-Visual Profile
AVPF	Audio-Visual Profile With Feedback
BCI	Backward Call Indicator
BCP	Basic Call Processing
BFCP	Binary Floor Control Protocol
BNEA	Busy not Equipped Announcement
BNF	Backus-Naur Form
BPA	Blocked Precedence Announcement
CAL	Confidentiality Access List
CE	Customer Edge
CE-R	Customer Edge Router
CF	Call Forwarding
CGB	Circuit Group Blocking Message
COT	Continuity Testing
CPN	Calling Party Number
DoD	Department of Defense
DSN	Defense Switched Network
ECT	Explicit Communication Transfer
EI	End Instrument
EO	End Office
FCC	Federal Communications Commission
FCI	Forward Call Indicator
FECC	Far End Camera Control
FIR	Full Intra Request
FQDN	Fully Qualified Domain Name

ACRONYM	DEFINITION
GRS	Group Reset
HTTP	HyperText Transfer Protocol
IANA	Internet Assigned Numbers Authority
IAW	In Accordance With
ICA	Isolated Code Announcement
IE	Information Element
IEEE	Institute of Electrical and Electronics Engineers
IETF	Internet Engineering Task Force
IP	Internet Protocol
ISDN	Integrated Services Digital Network
ISUP	Integrated Services Digital Network User Part
ITU-T	International Telecommunication Union – Telecommunication
IWF	Interworking Function
LRN	Location Routing Number
MCU	Multipoint Conferencing Unit
MG	Media Gateway
MGC	Media Gateway Controller
MIME	Multi-Purpose Internet Mail Extension
MLPP	Multilevel Precedence and Preemption
MPI	Minimum Picture Interval
NALU	Network Abstraction Layer Unit
NE	Network Element
NMS	Network Management System
NTP	Network Time Protocol
OCN	Original Called Number
P&P	Precedence and Predemption
PCMA	Pulse Code Modulation A-Law
PCMU	Pulse Code Modulation μ -Law
PLI	Picture Loss Indication
PRACK	Provisional Response Acknowledgement
PSTN	Public Switched Telephone Network
RBVS	Role-Based Video Stream
RFC	Request for Comments
RO	Routine Only
RPSI	Reference Picture Selection Indication
RSC	Reset Circuit

ACRONYM	DEFINITION
RTP	Real-Time Transport Protocol
SAL	Security Access Level
SBC	Session Border Controller
SBU	Sensitive but Unclassified
SC	Session Controller
SDP	Session Description Protocol
SIP	Session Initiation Protocol
SLI	Slice Loss Indication
SPRT	Simple Packet Relay Transport
SS	Softswitch
SSE	State Signaling Event
TCP	Transmission Control Protocol
TDM	Time Division Multiplexing
TIAS	Transport Independent Application Specific
TLS	Transport Layer Security
UAC	User Agent Client
UAS	User Agent Server
UC	Unified Capabilities
UCR	Unified Capabilities Requirements
UDP	User Datagram Protocol
UPA	Unauthorized Precedence Announcement
URI	Uniform Resource Indicator
URN	Uniform Resource Name
UUID	Universally Unique Identifier
VCA	Vacant Code Announcement
VCL	Video Coding Layer
WAN	Wide Area Network